

N**Monteringsanvisning****EN****Assembly Instructions****S****Monteringsanvisning**

Produkt nr. / Product no. / Produkt nr.

16-101-385**Sort / Grå**

Ord. nr. _____

Dato. _____

Sign. _____

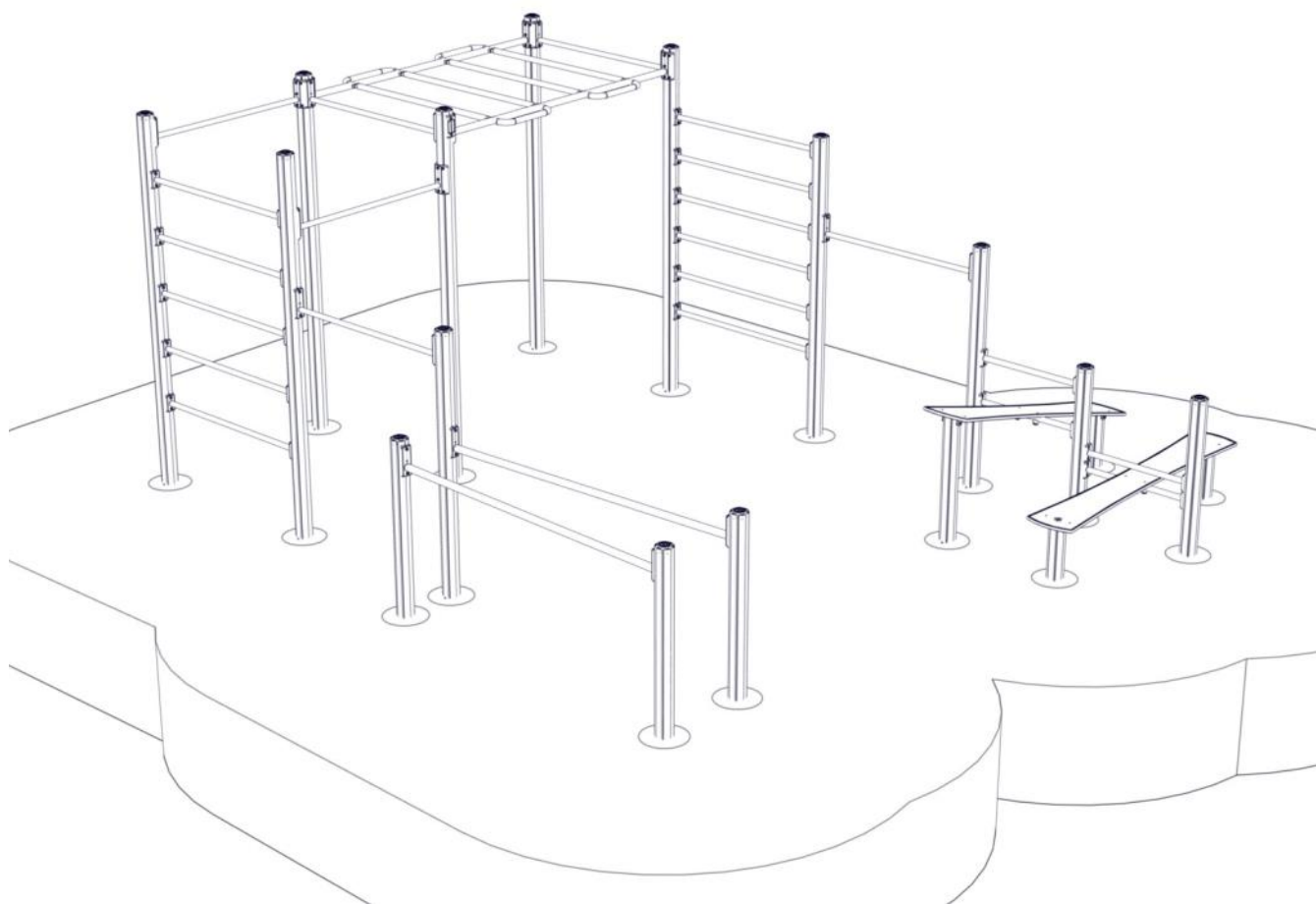
**søve**

Søve AS
Grønnvoldveien 290
3830 Ulefoss - Norway
Tlf: +47 35 94 65 65
www.sove.no



Søve AB
EA Rosengrensgatan 32
421 31 Västra Frölunda
Phone: +46 (0)31 773 97 00
www.sove.se

Monteringstips / Assembly Advice / Monteringsstips**N**

- Les monteringsanvisningen nøye før montering.
- Monter elementene i rekkefølgen som vist.
- Boltene bør ikke skrues for hardt til før alt er montert, vatret og loddet. Skru så boltene til.
- NB! Ved bruk av drill, kan boltene ryke.
- På grunn av at solen kan gjøre rutsjeflaten veldig varm, bør rutsjebanens utløp vende mot nord-øst eller nord-vest.
- Er lekeutstyret plassert i naturlige ferdselstraséer må området sikres mot gjennomgang.
- Innspringningshinder bør vurderes rundt lekeapparater hvor det er stor bevegelse, f.eks. ved huskestativ.
- Det bør være fritt innsyn til lekeutstyr som er beregnet for barn under 3 år.

NB! Under monteringsarbeidet må utstyr, som ikke er forankret forsvarlig i bakken, sikres slik at det ikke velte.

Området må avstenges under montering av apparatene med sperrebånd eller lignende.

EN

- Read the instruction carefully before assembling the play unit.
- Assemble the components in the sequence shown in these instructions. Fixings must not be fully tightened during assembly. Before casting the foundations, the structure must be level and plumb, at which point all fixings are tightened. PS! If use of drill, the bolts may be wrecked.
- Avoid positioning the slide facing due south because of overheating – ideal positions are facing north-east or north-west. Secure the construction-area to prevent people from walking through it.
- Consider installing barriers around play-equipment which gives rise to a lot of activity – i.e. swings.
- Ensure that clear vision is possible across the play area so that supervision is possible from any position, particularly where children under 3 years of age will be playing.

NB! During assembly of the equipment, ensure that all structures are securely propped, especially when left overnight. Also ensure that equipment is supported

Monteringstips / Assembly Advice / Monteringsstips**S**

- Läs monteringsanvisningen noga före montering.

- Montera delarna i den ordningen som anvisas
- Skruvarna bör inte skruvas för hårt tills allt är monterat, i våg och lodat.









OBS! Används elektrisk skruvdragare, kan bulten gå sönder. Hårdra därför manuellt!

- Solen kan göra att rutchbanan blir väldigt varm. Banans nedfart rekommenderas att vändas i norrlig riktning
- Om lekplatsen placeras vid en gångväg mm bör området säkras mot genomfart av gående och cyklister.
- Insprängningshinder bör placeras runt lekutrustning med stor rörelse, t ex, gungställning.
- Det bör vara fri insyn till lekutrustning beräknat till barn under 3 år.

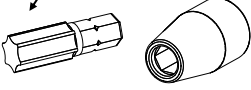
OBS! Under monteringsarbete bör utrustningen som inte ska förankras i marken, ställs så att den inte kan välta.

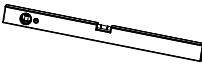
Området måste spärras när lekutrustningen byggs upp, med avspärrningsband eller liknande.

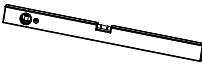
Nødvendig verktøy / Tools required / Nödvändiga verktyg



| | | | | | |
|-----------------------------------|--|---|---|--|--|
| <p>(N)</p> <p>(EN)</p> <p>(S)</p> | <p>(A)</p>  | <p>(B)</p> <p>Torx Nr 45 High quality</p>  | <p>(C)</p> <p>13 + 17mm</p>  | <p>(D)</p>  | <p>(E)</p>  |
| |  | <p>Metermål Metric measure Tumstock</p>  | <p>16 V</p>  | <p>Merkebånd Mark ribbon Märkeband</p>  | <p>5 mm 6 mm</p>  |

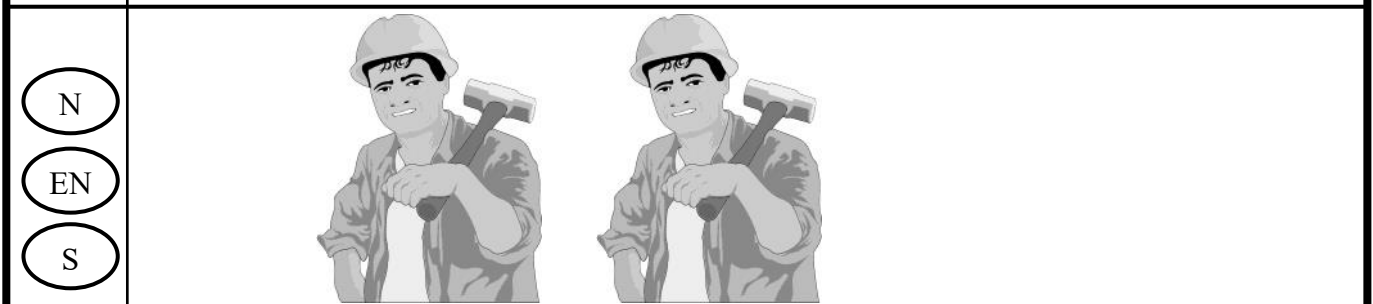



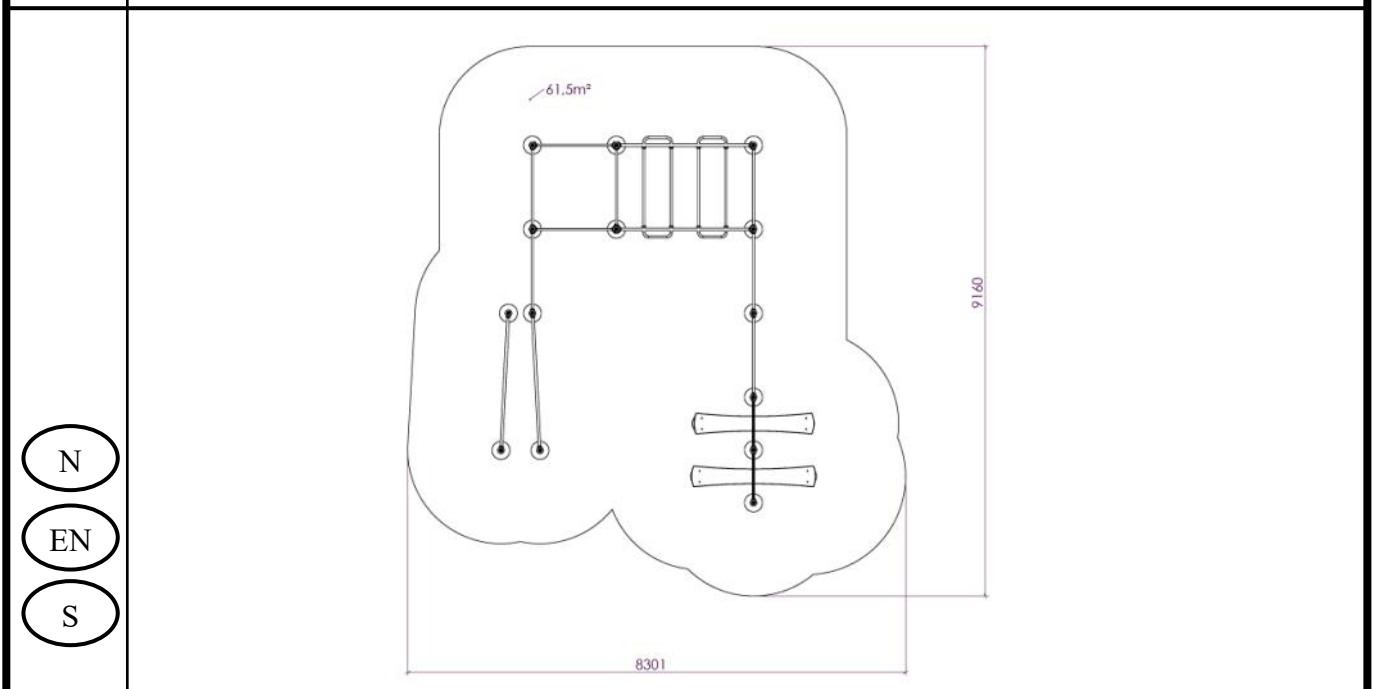

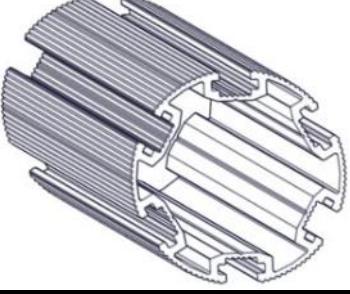
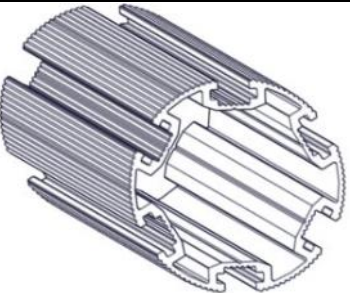
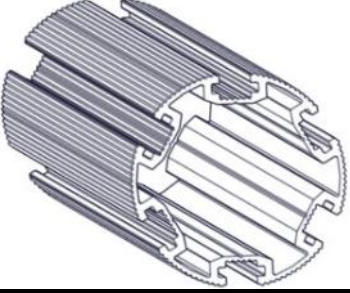
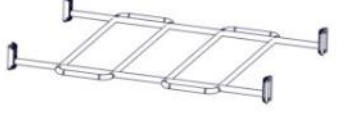
Nødvendig antall personer / Number of persons required / Rekommenderad antal personer









Anbefalt arealbehov ved montering / Recommended working space / Rekommenderad arealbehov vid montering



| Boltepakker for / Boltpackage for / Bultpaket för | | Sign. _____ | | |
|---|---|--|------------|------------|
| Sort-Grå 16-101-385 | Navn | Artnr/ dimensjon | Ant | Lev |
|  | Stolpe Ø110 L=3250 (2650-600) | SFA5126/2 | 6 | |
| | Stolpe Ø110 L=2850 (2250-600) | SFA5126/2 | 1 | |
| | Stolpe Ø110 L=2400 (1800-600) Grå | SFA5126/2 | 1 | |
|  | Stolpe Ø110 L=2350 (1750-600) | SFA5126/2 | 1 | |
| | Stolpe Ø110 L=1800 (1200-600) | SFA5126/2 | 3 | |
| | Stolpe Ø110 L=1700 (1100-600) Grå | SFA5126/2 | 2 | |
|  | Stolpe Ø110 L=1508 skrå (908-600) | 07-100-361 | 1 | |
| | Stolpe Ø110 L=1040 skrå (440-600) | 07-100-363 | 1 | |
| | Stolpe Ø110 L=1000 (400-600) Grå | SFA5126/2 | 2 | |
|  | Workoutbro inkl 30gr beslag Sort | 07-200-175K (Se egen del- montering) | 1 | |
|  | Workout rør cc1400 0gr Sort | 07-200-164K (Se egen del- montering) | 11 | |
|  | Workout rør L=1270mm 30gr 200 Beslag Sort | 07-200-166K (Se egen del- montering) | 2 | |

| Boltepakker for / Boltpackage for / Bultpaket för | | Sign. _____ | | |
|---|--|--|------------|------------|
| Sort-Grå 16-101-385 | Navn | Artnr/ dimensjon | Ant | Lev |
|  | Workout rør Ø33 L=1270 0gr Sort | 07-200-165K (Se egen del- montering) | 4 | |
|  | Sperrerør rett workout 30gr beslag cc650 Sort | 07-500-081K (Se egen del- montering) | 1 | |
|  | Sperrerør rett workout 30gr beslag cc400 Sort | 07-500-082K (Se egen del- montering) | 1 | |
|  | Workout rør 0gr Ø44,5 L=2160 CC400-650 Venstre Sort | 07-200-183K (Se egen del- montering) | 1 | |
|  | Workout rør 0gr Ø44,5 L=2160 CC400-650 Høyre Sort | 07-200-182K (Se egen del- montering) | 1 | |
|  | Sperrerør 0gr sittebrett L=750 Sort | 07-200-128K (Se egen del- montering) | 1 | |

| Boltepakker for / Boltpackage for / Bultpaket för | | Sign. _____ | | |
|---|---|--|------------|------------|
| Sort-Grå 16-101-385 | Navn | Artnr/ dimensjon | Ant | Lev |
|  | Sperrerør med 15gr beslag, sittebrett L=750 Sort | 07-200-129K (Se egen del- montering) | 1 | |
|  | Sittup Brett med gummi m/feste | 07-200-224K (Se egen del- montering) | 2 | |
|  | Sperrerør rett uten hull Komplett L=750 Sort | 07-500-075K (Se egen del- montering) | 2 | |
|  | Produktmerke | 07-500-500 | 1 | |
|  | Endelokk til stolpe Ø110 | 00-400-995 | 14 | |
|  | Fotfeste trening | 30-490-100K (Se egen del- montering) | 1 | |

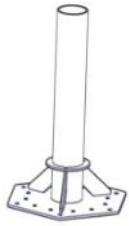
| Boltepakker for / Boltpackage for / Bultpaket för | | Sign. _____ | | |
|---|---|--|------|-----|
| Sort-Grå 16-101-385 | Navn | Artnr/ dimensjon | Ant | Lev |
| | Støp fundament | | | |
|  | Fundament betong Ø110 | 00-003-111K (Se egen del- montering) | 18 | |
| | | | | |
| | Overflate montering | | | |
|  | Fundament 1xØ110 for Betongdekk Ekstra | 00-003-137K (se egen del- montering) | 12 | |
| | Fundament 1xØ110 for Betongdekk Ekstra KORT For situp Brett | 00-003-151K (se egen del- montering) | 6 | |
| | Stolpe må kappes | SFA5126/2 | (18) | |

Fundamentering med betong / Foundation concrete / Förankring med betong

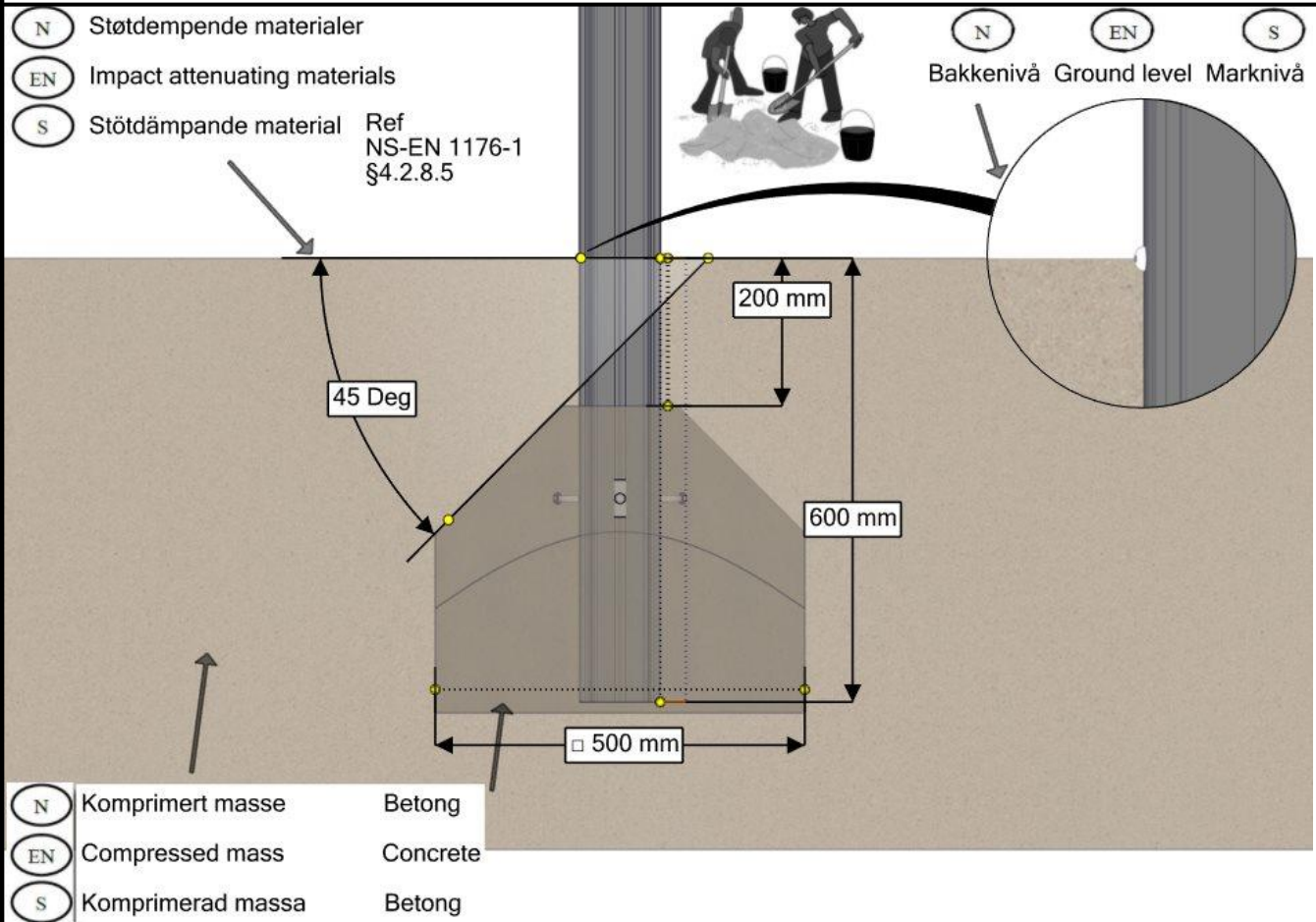

Overflatemontering / Surface mounting / Ytmontering

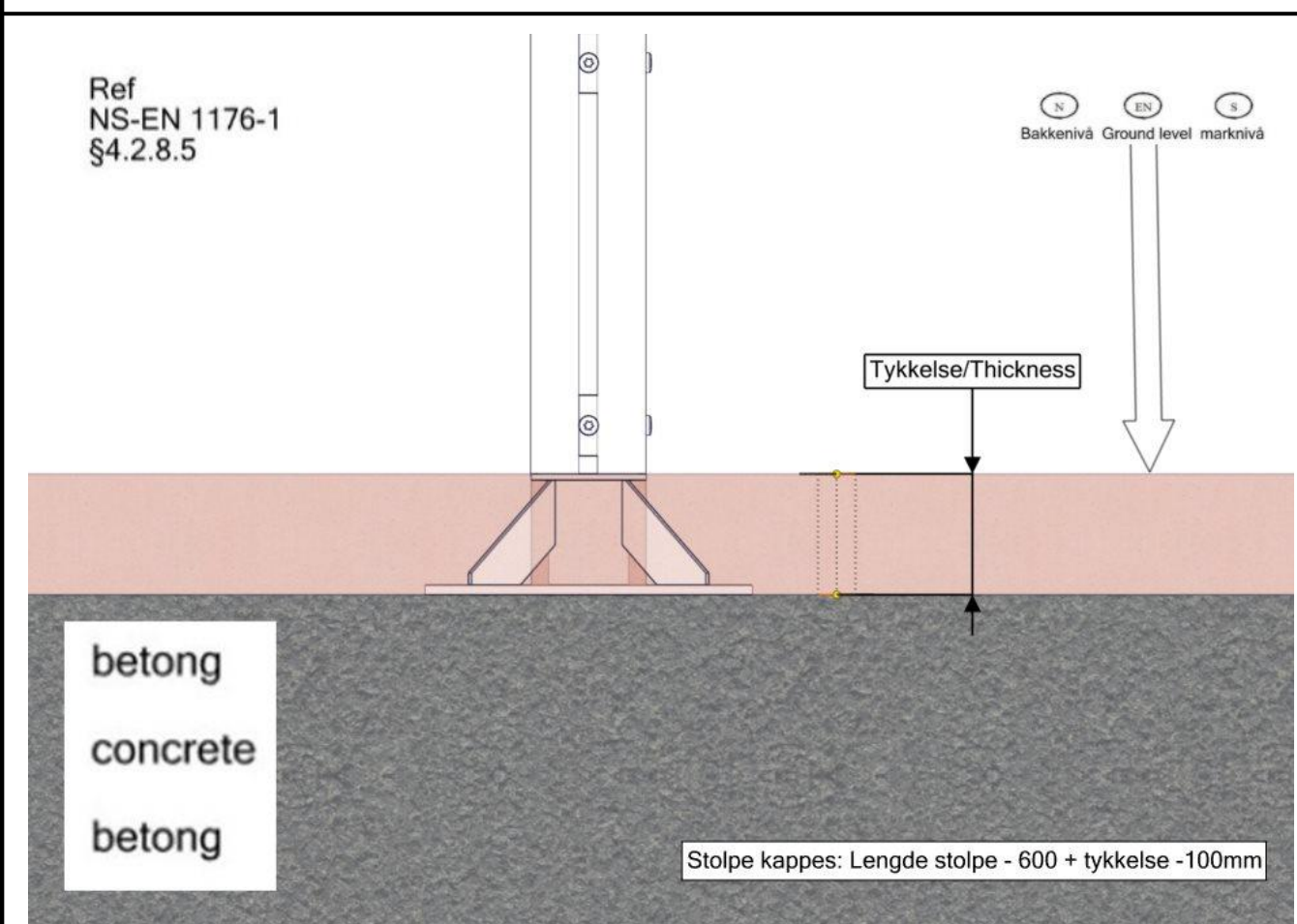

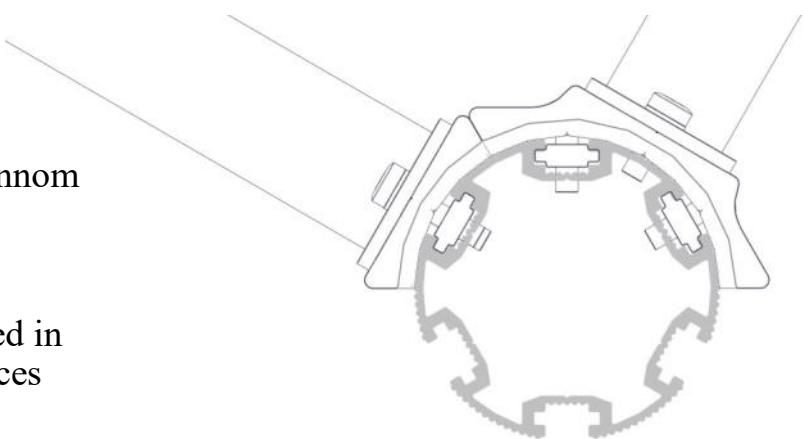
| | | | | |
|--|---|-------------------------|-------------------------------|----------------|
| N | <p>Bolten skrues HELT igjennom aluminiumen. Maks moment: 30Nm</p> | | | |
| EN | <p>The bolt must be tightened in to the post, so that it peirces the aluminium Max torque: 30Nm</p> | | | |
| S | <p>Bulten skuvas HELT genom aluminiumen. Maks vridmoment: 30Nm</p> | | | |
|  | | | | |
| NO | Betongkvalitet | C25/30 | | |
| SE | Betongkvalitet | | | |
| EN | Concrete quality | | | |
| NO | Mengde betong | | 2,7 | m ³ |
| SE | Mängd betong | | | |
| EN | Amount of concrete | | | |
| NO | Fundament størrelse | | 0,5 x 0,5 x 0,6 | m |
| SE | Stiftelsestorlek | | | |
| EN | Foundation size | | | |
| NO | For sikkerhet må fundamentene med sand eller myk jord være minst 50% større i areal | | | |
| SE | För säkerheten måste grunden med sand eller mjuk jord vara minst 50% större i området | | | |
| EN | For safety, the foundations with sand or soft soil must be at least 50% larger in area | | | |
| NO | Tyngste element | 07-200-175 | 23 | Kg |
| SE | Tyngsta element | | | |
| EN | Heaviest element | | | |
| NO | Største element | SFA5126/2 07-200-175 | 3,3x Ø 0,11 2,17x1,68x0,19 | m |
| SE | Största element | | | |
| EN | Biggest element | | | |

Fallhøyder / Free height of fall / Fallhöjder

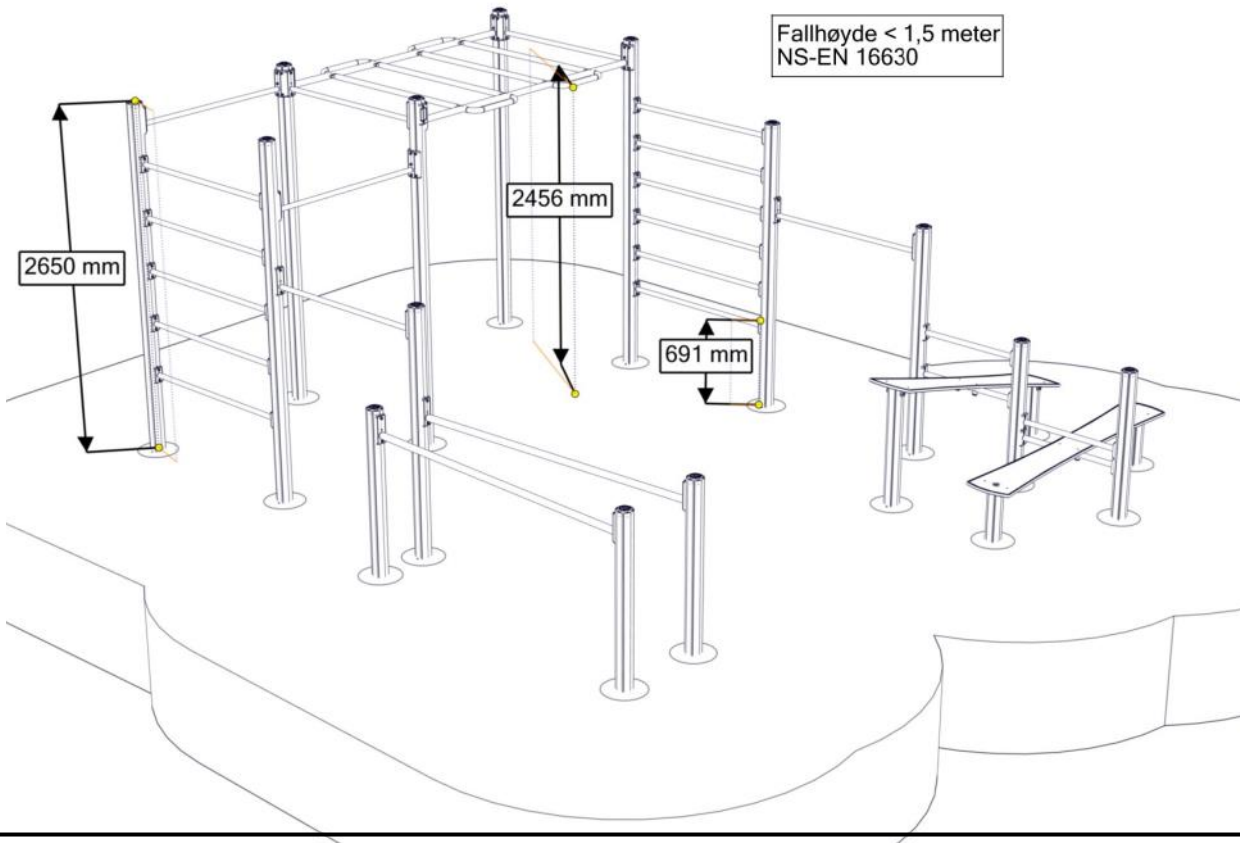

Sikkerhetszone / Safety zone / Säkerhetszon

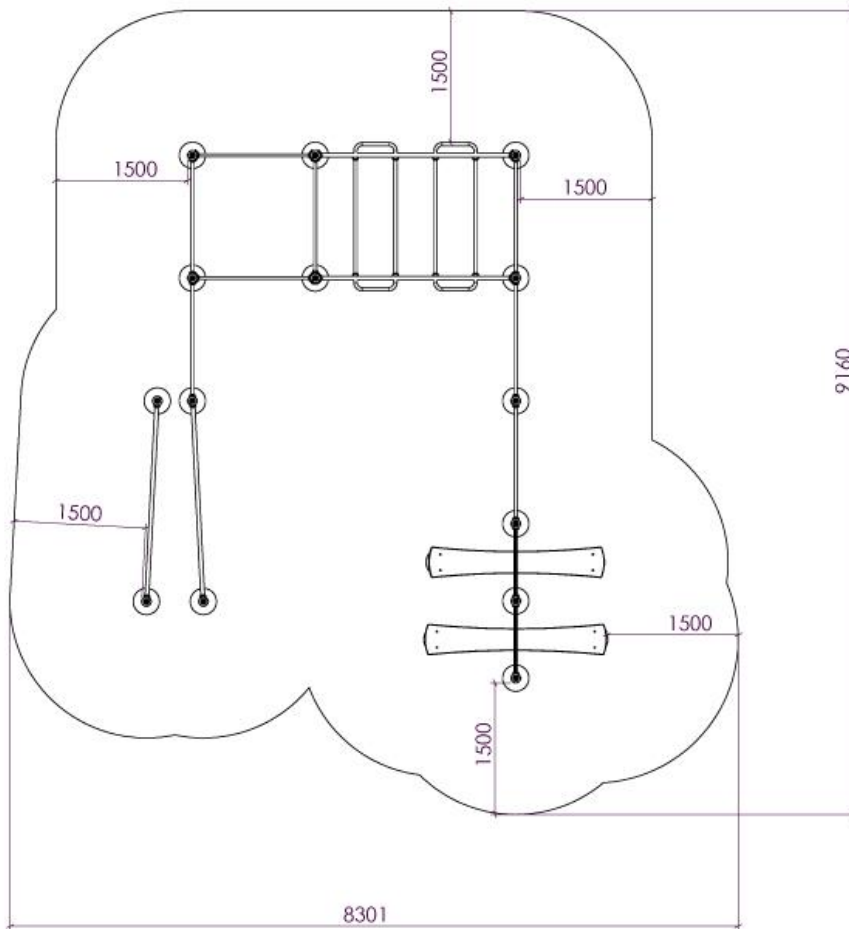

Plassering av forankringer / Ground plan / Placering av förankringar

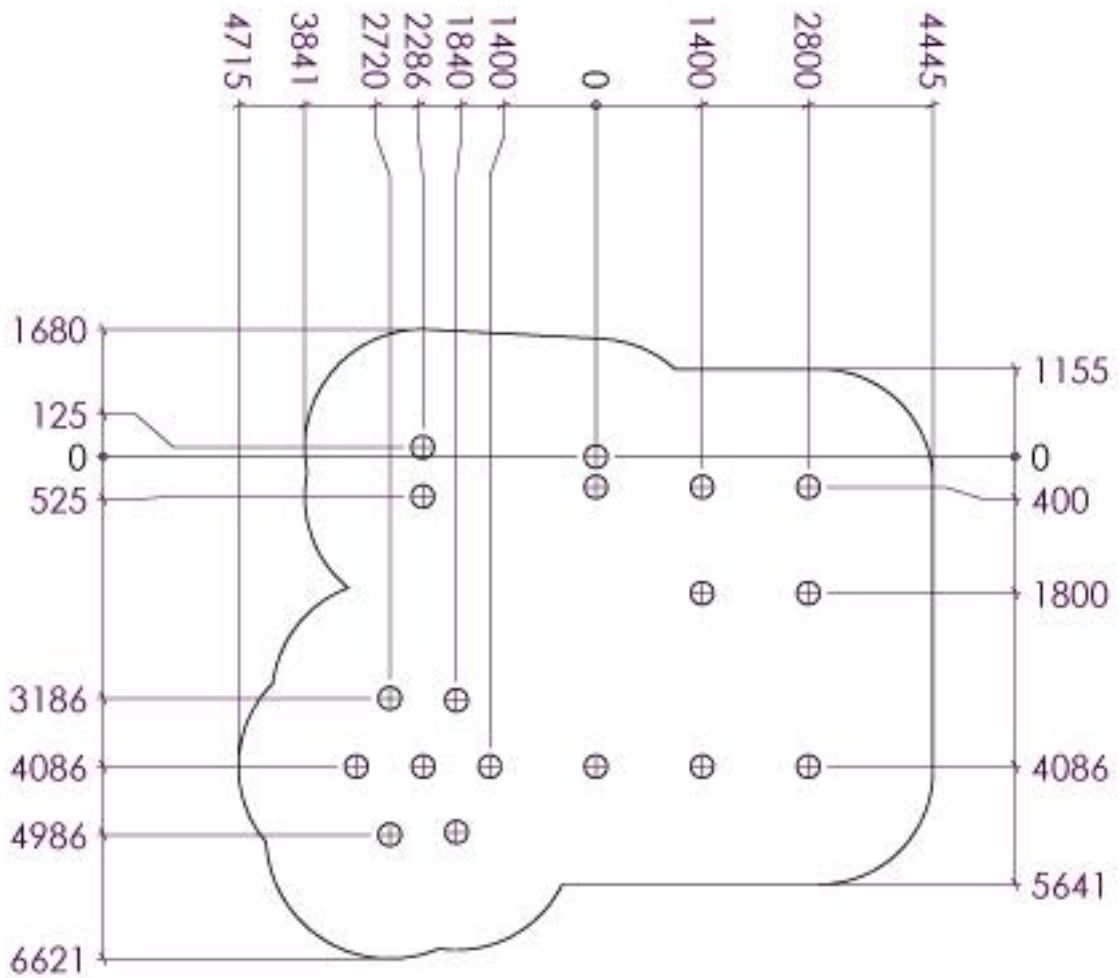

N

Alle mål er oppgitt i millimeter

EN

Scale measured in mm

S

Alla mått är i millimeter.

Montering av lekeapparatet / Assembly instructions / Montering av lekredskapet

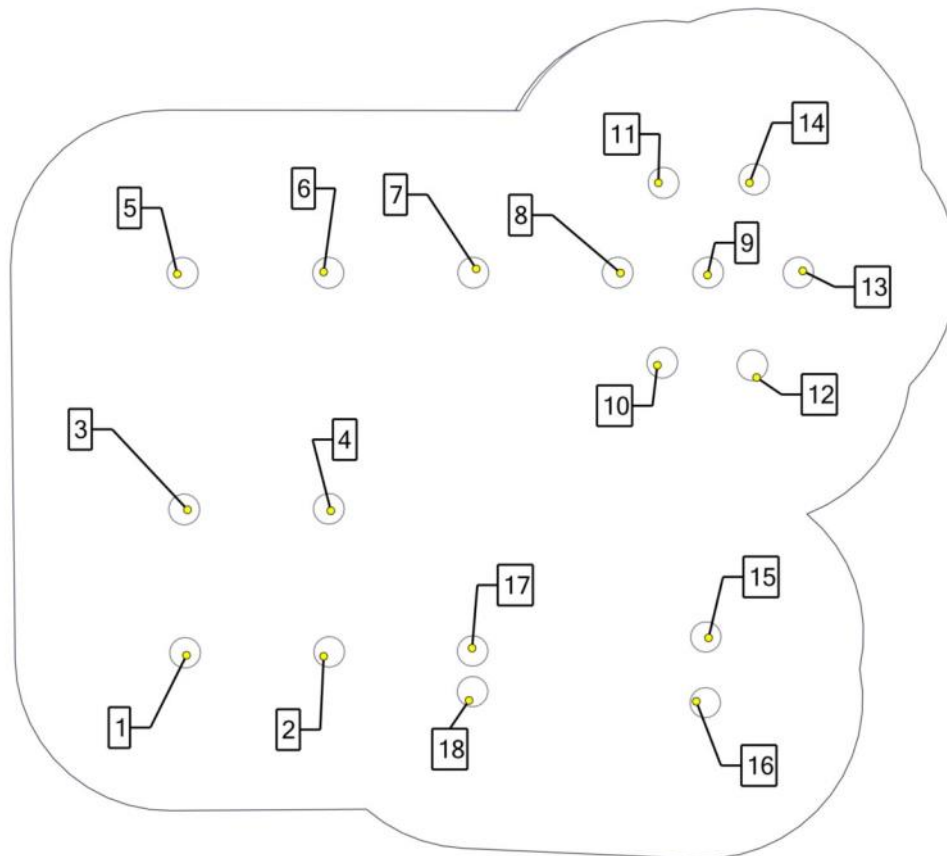

Se separat delmontering for detaljer
 See separate assembly for details
 Se separata delmontering för detaljer

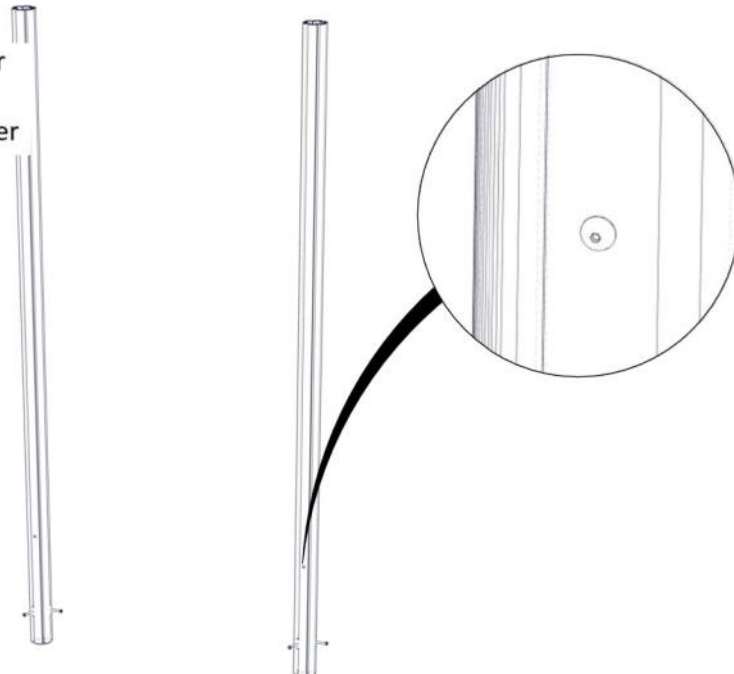

| Part Name | Article nr. | Qty |
|-------------------------------|-------------|-----|
| Støpe fundament Ø 110 | 00-003-111K | 2 |
| Stolpe Ø110 L=3250 (2650-600) | SFA5126/2 | 2 |

Se separat delmontering for detaljer
 See separate assembly for details
 Se separata delmontering för detaljer

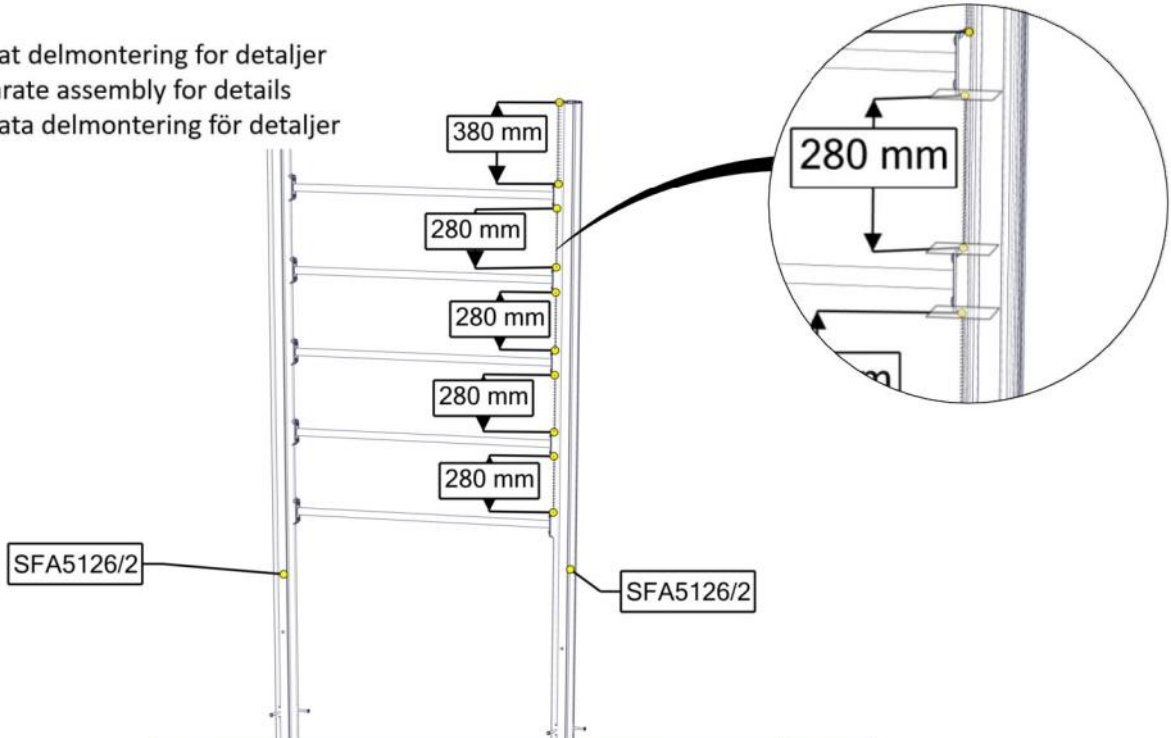

| Part Name | Article nr. | Qty |
|------------------------|-------------|-----|
| Workout rør CC1400 0gr | 07-200-164k | 5 |

Se separat delmontering for detaljer
 See separate assembly for details
 Se separata delmontering för detaljer

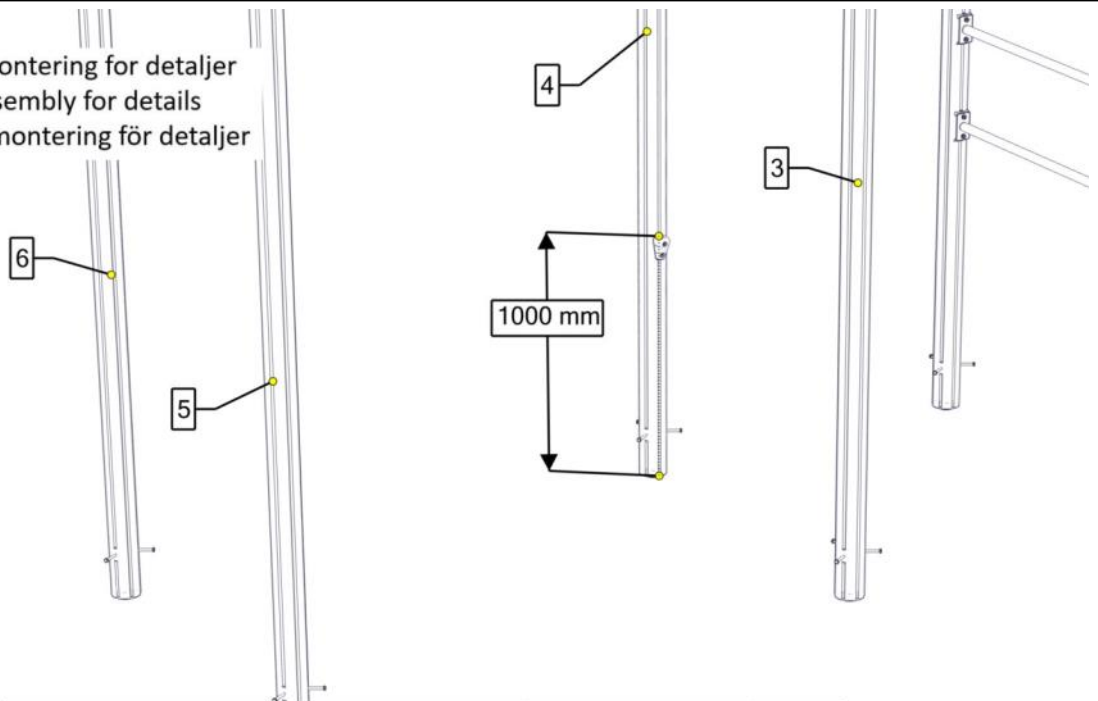

| Part Name | Article nr. | Qty |
|-------------------------------|-------------|-----|
| Støpe fundament Ø 110 | 00-003-111K | 4 |
| Stolpe Ø110 L=3250 (2650-600) | SFA5126/2 | 4 |
| Fotfeste trening Ø110 stolpe | 30-490-100K | 1 |

Se separat delmontering for detaljer
 See separate assembly for details
 Se separata delmontering för detaljer

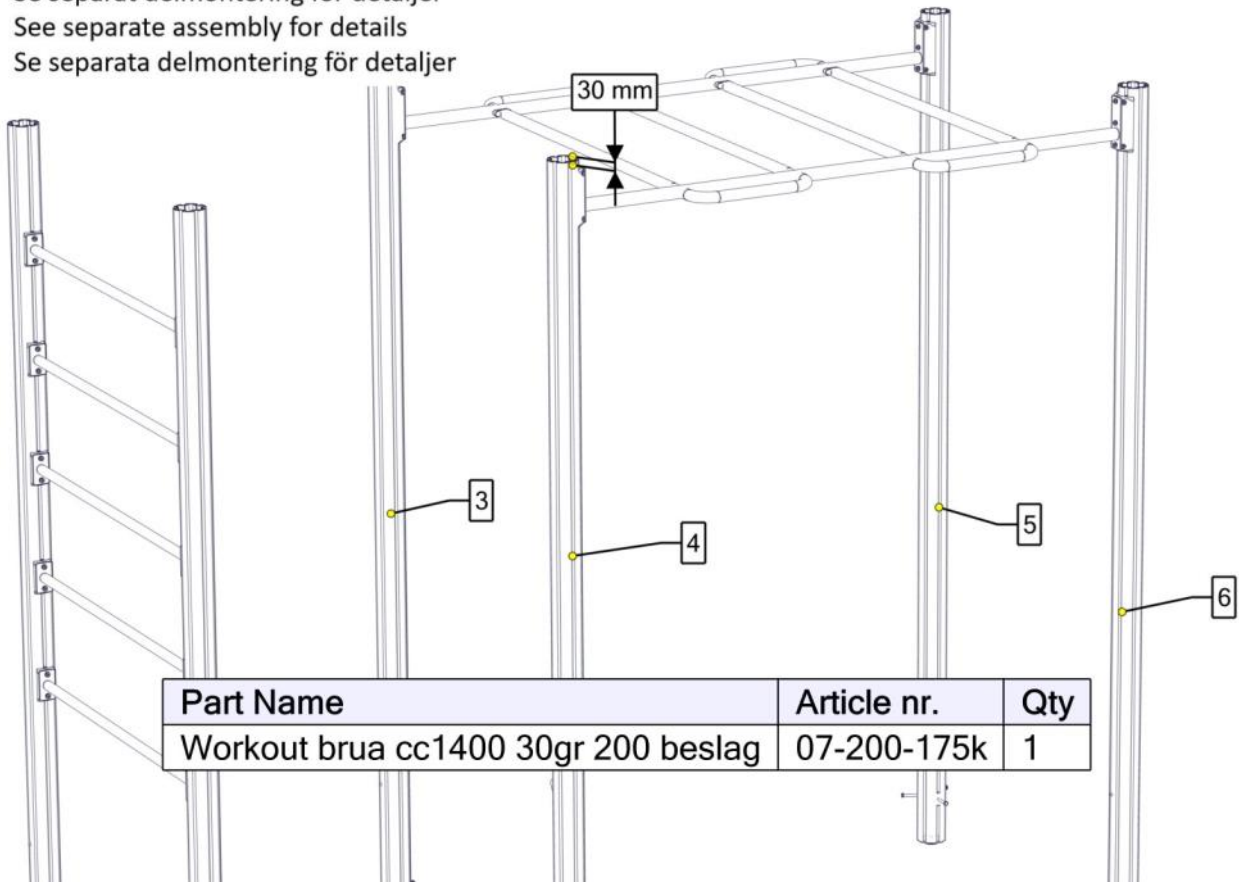

Se separat delmontering for detaljer
 See separate assembly for details
 Se separata delmontering för detaljer

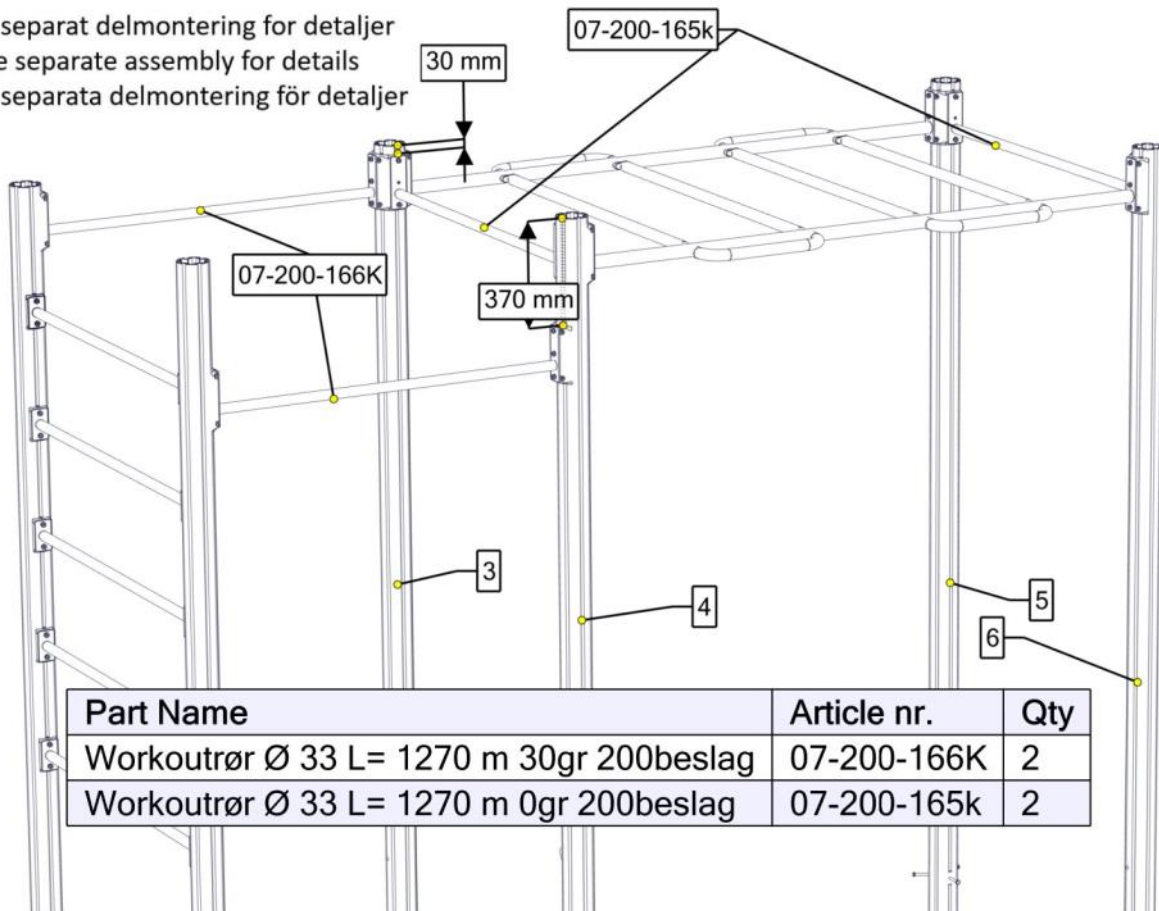

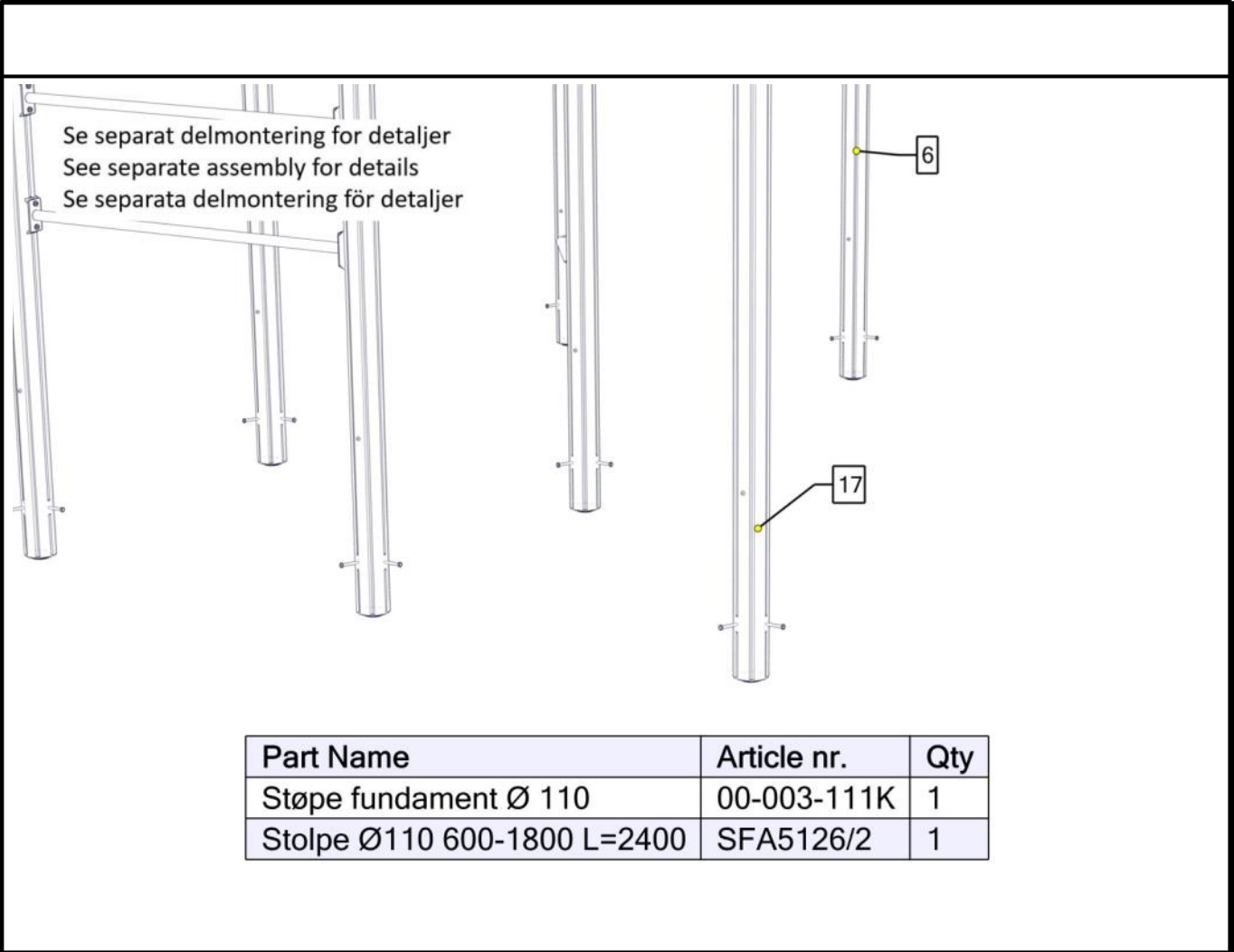

| Part Name | Article nr. | Qty |
|-----------------------------|-------------|-----|
| Støpe fundament Ø 110 | 00-003-111K | 1 |
| Stolpe Ø110 600-1800 L=2400 | SFA5126/2 | 1 |

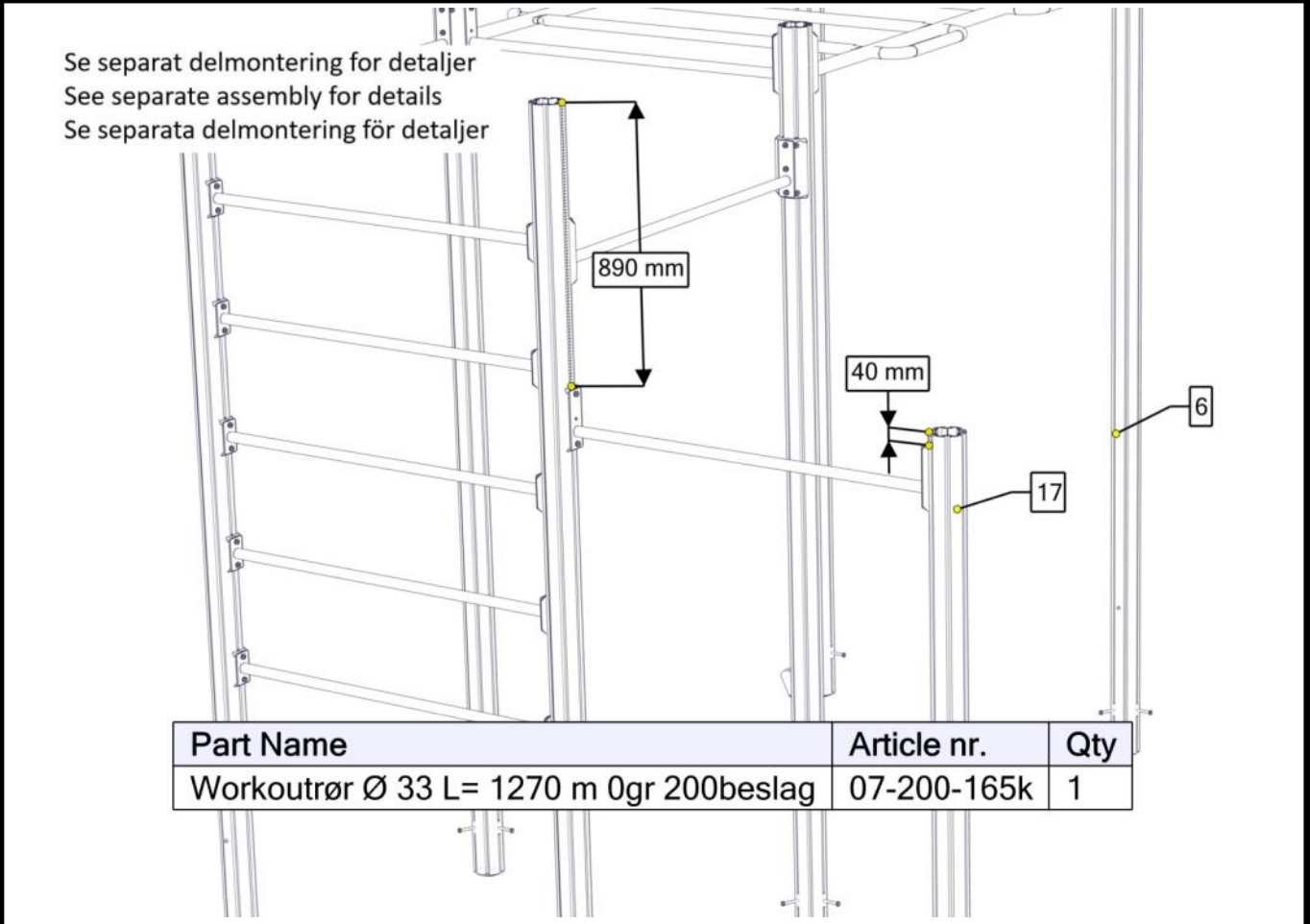

| Part Name | Article nr. | Qty |
|---|-------------|-----|
| Workoutrør Ø 33 L= 1270 m 0gr 200beslag | 07-200-165k | 1 |

Se separat delmontering for detaljer
 See separate assembly for details
 Se separata delmontering för detaljer

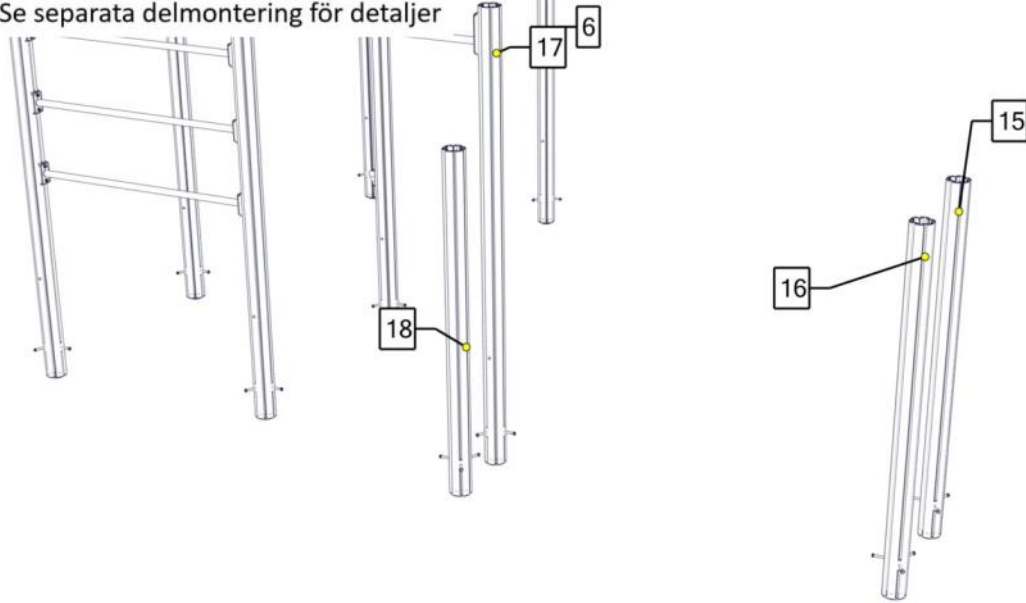

| Part Name | Article nr. | Qty |
|------------------------|-------------|-----|
| Støpe fundament Ø 110 | 00-003-111K | 3 |
| Stolpe Ø110 L=1200-600 | SFA5126/2 | 3 |

Se separat delmontering for detaljer
 See separate assembly for details
 Se separata delmontering för detaljer

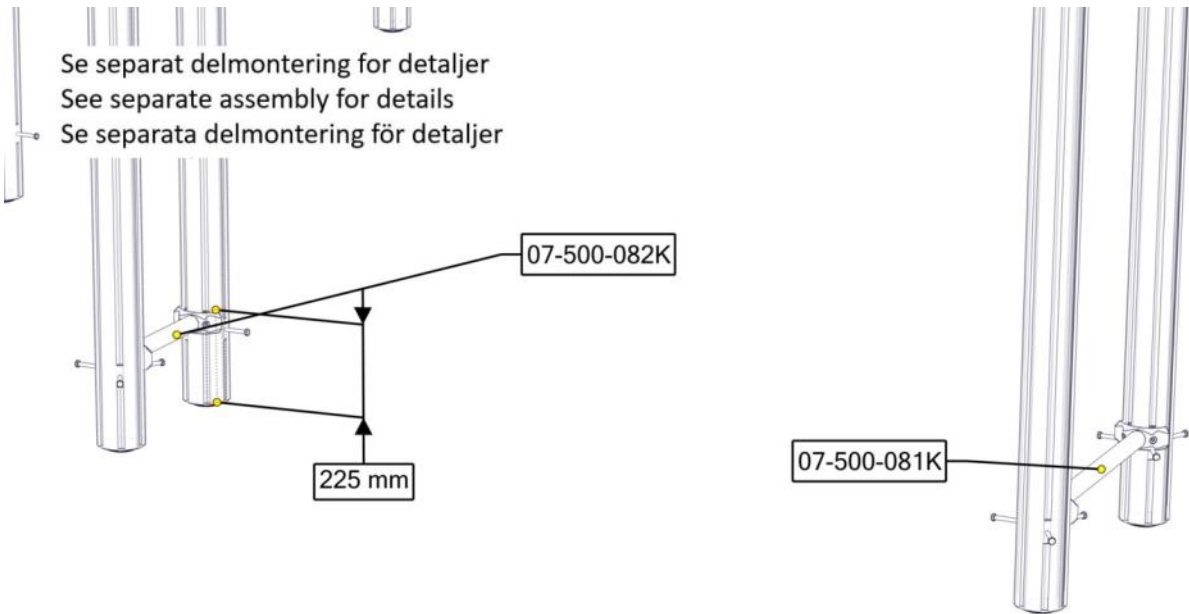

| Part Name | Article nr. | Qty |
|-----------------------------------|-------------|-----|
| sperreror_Rett_workout 30gr cc650 | 07-500-081K | 1 |
| sperreror_Rett_workout 30gr cc400 | 07-500-082K | 1 |

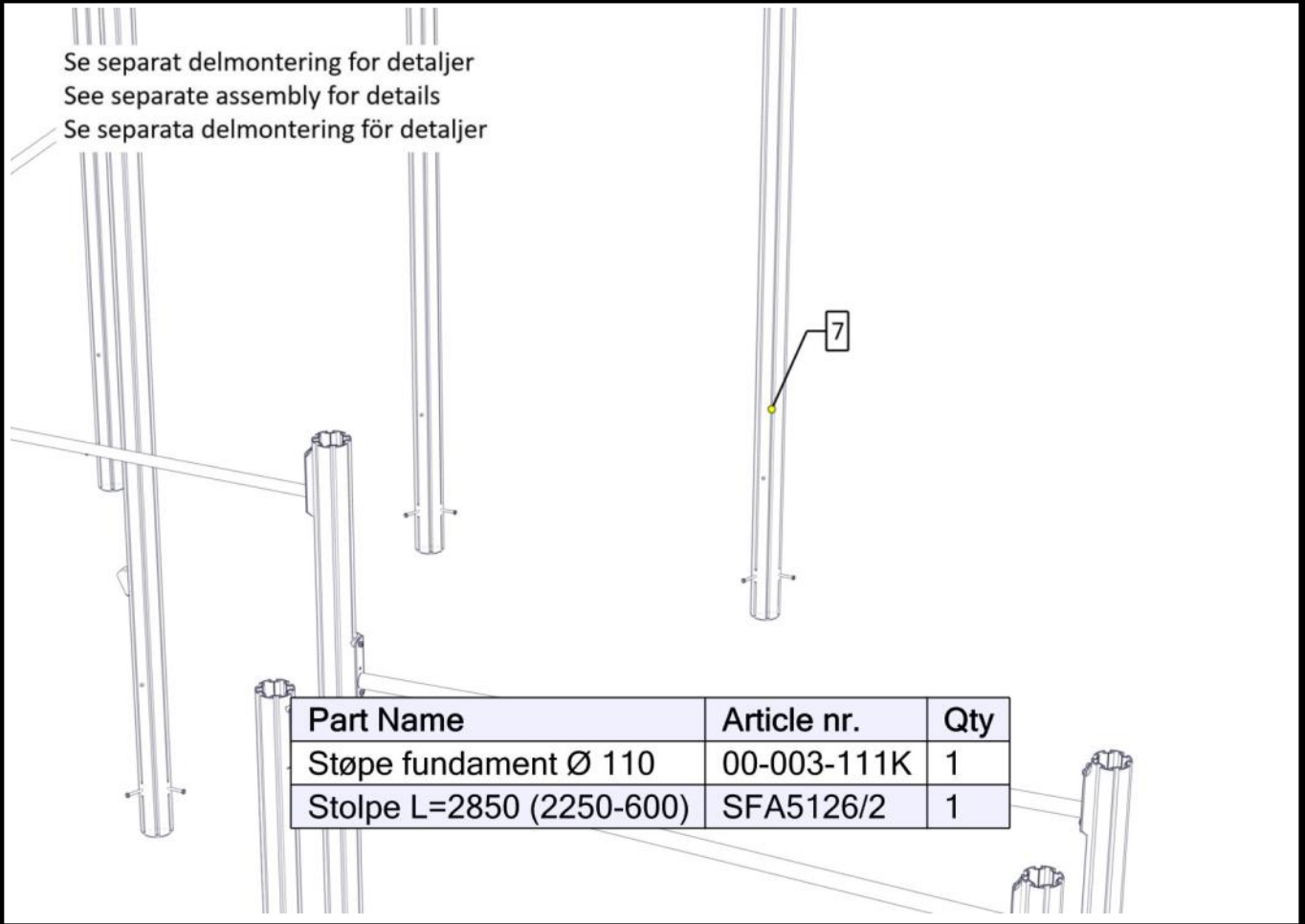
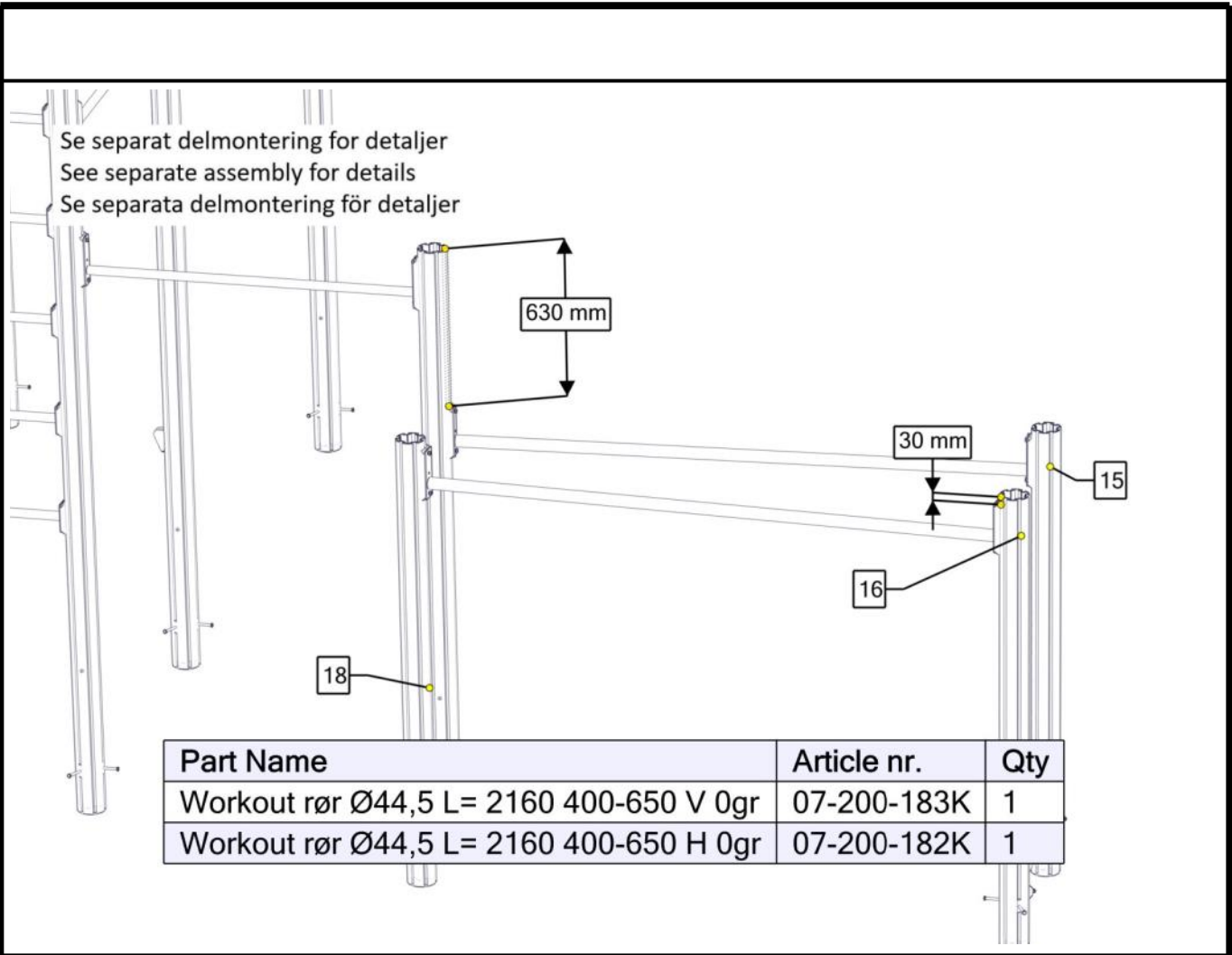

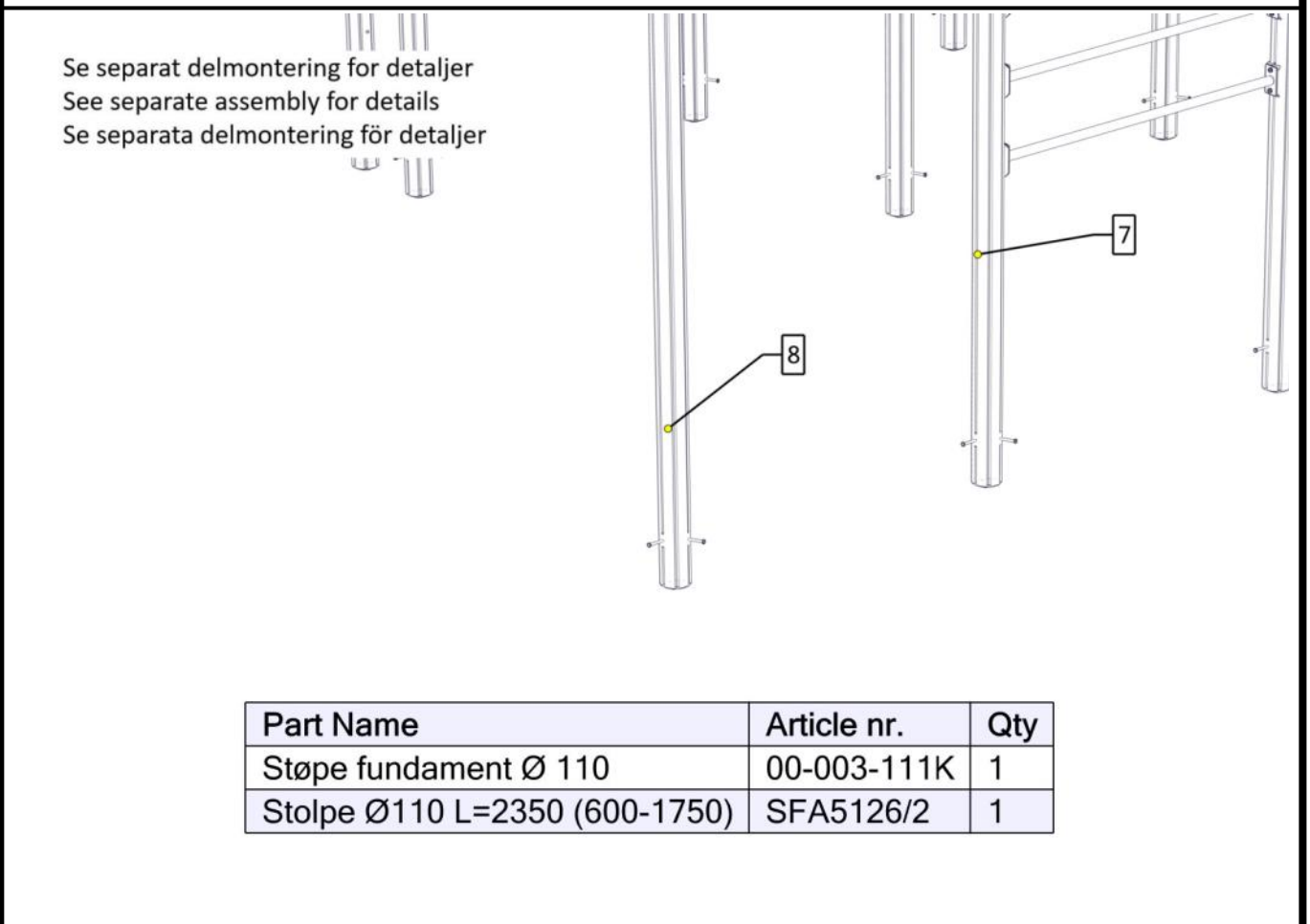
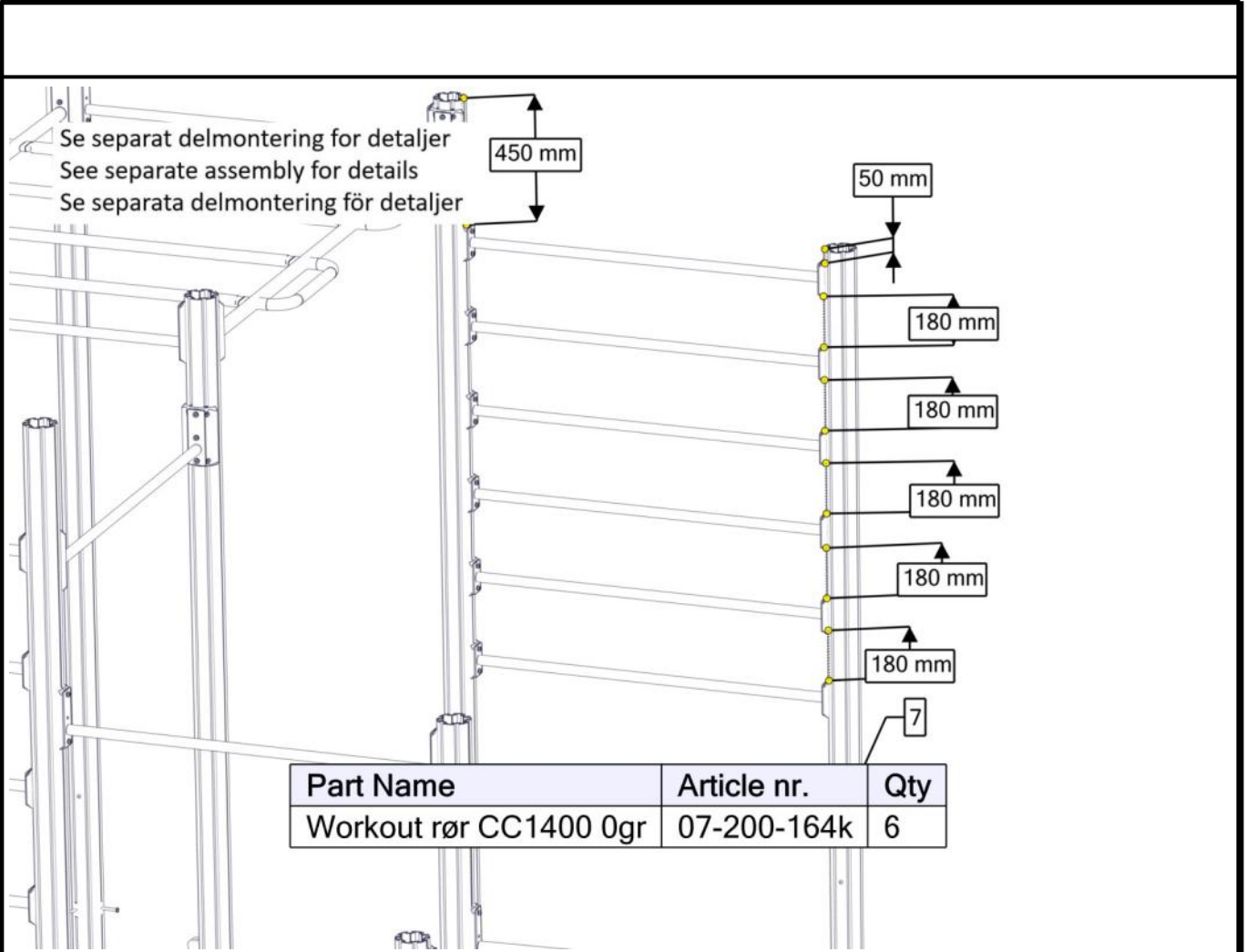

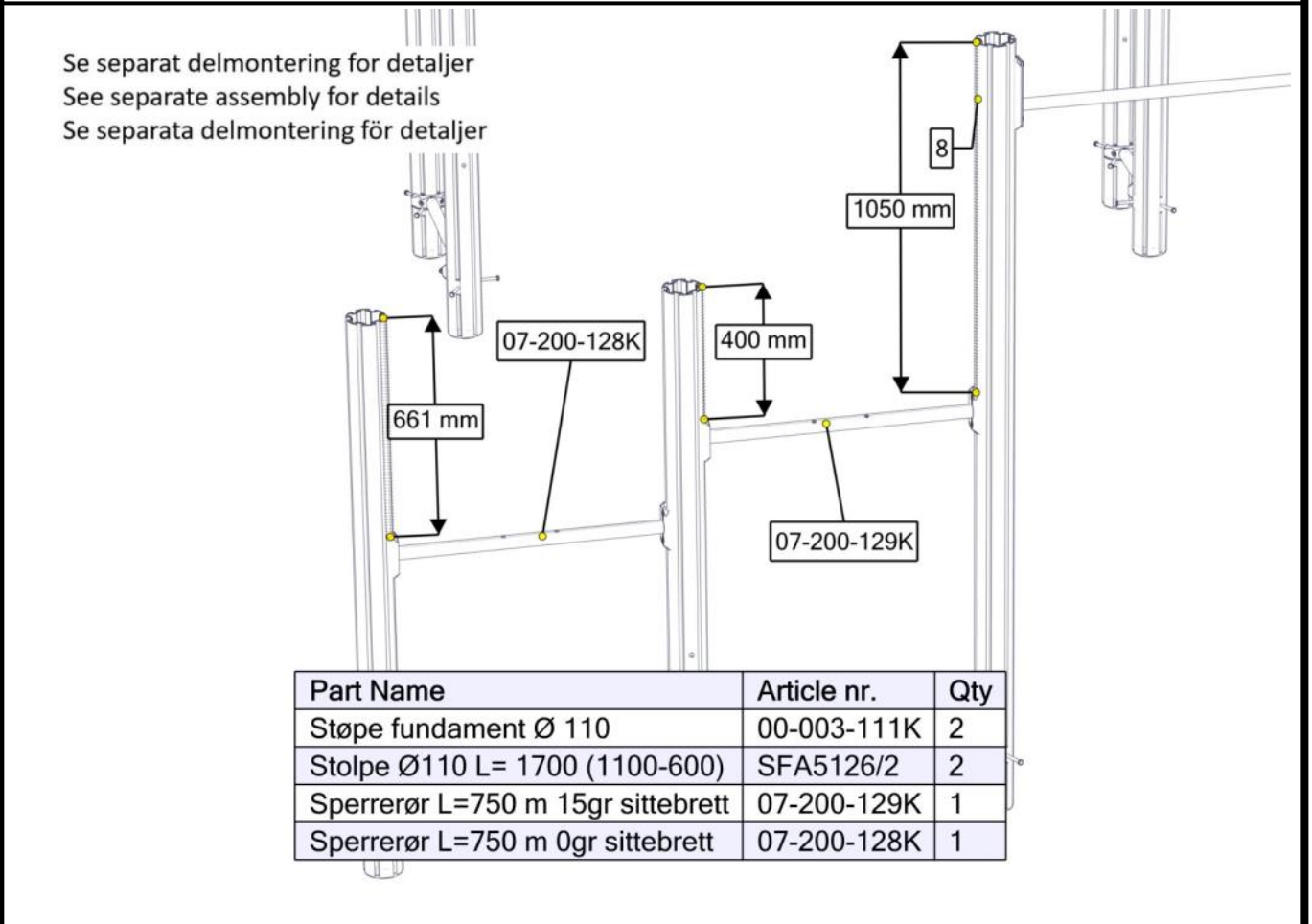
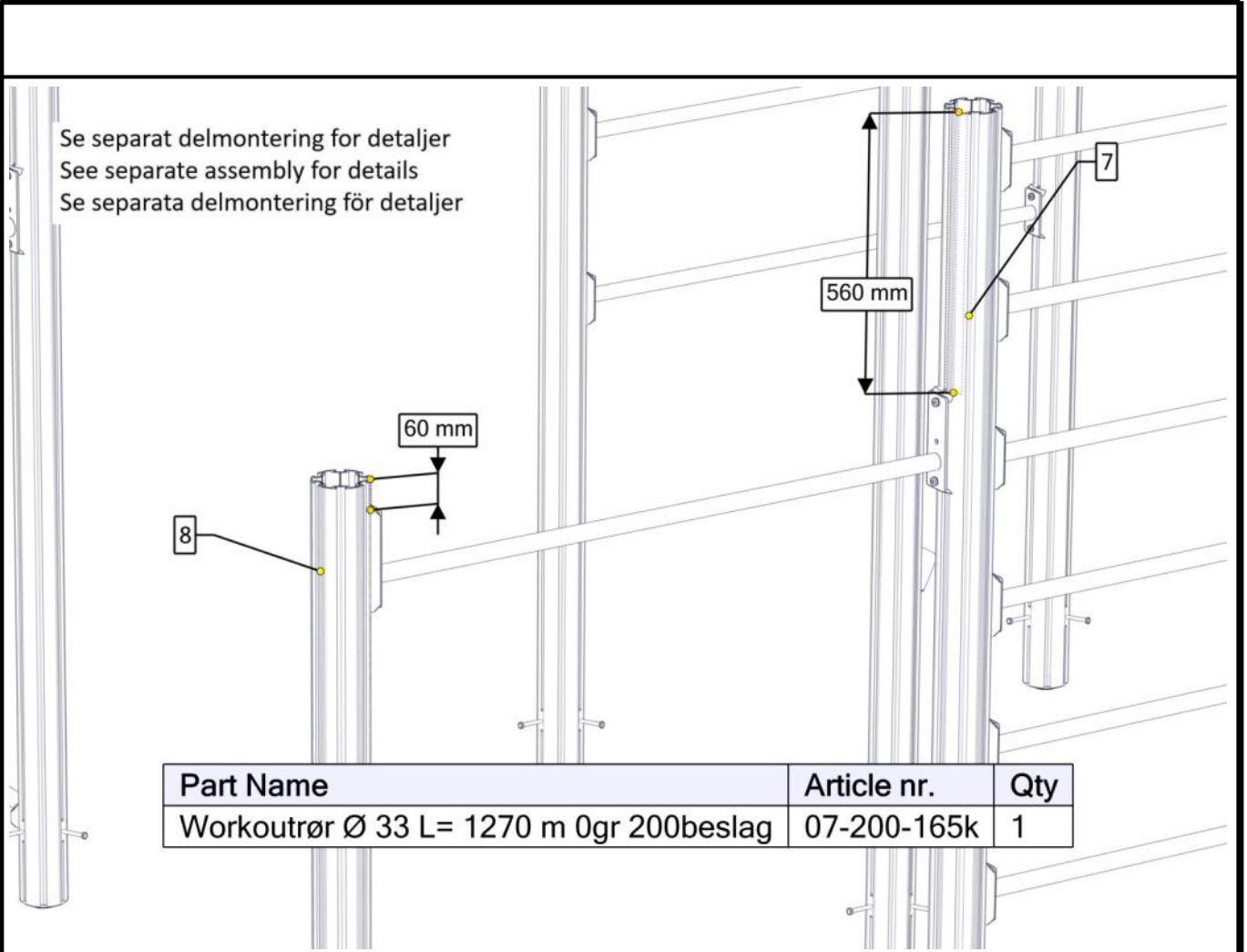

Se separat delmontering for detaljer
 See separate assembly for details
 Se separata delmontering för detaljer

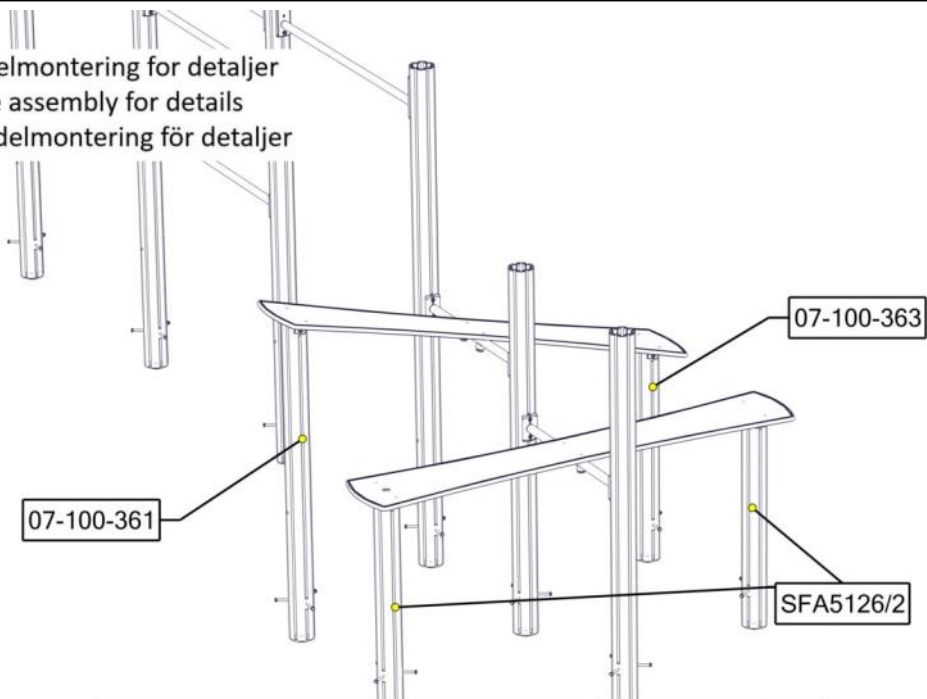

| Part Name | Article nr. | Qty |
|--|-------------|-----|
| Støpe fundament Ø 110 | 00-003-111K | 4 |
| Stolpe Ø110 Lengde = 1000 (400-600) | SFA5126/2 | 2 |
| Stolpe 110 skrå 15gr 600-908 L=1508 grey | 07-100-361 | 1 |
| Stolpe 110 skrå 15gr 600-440L=1040 Grey | 07-100-363 | 1 |
| Sittup Brett med gummi 0gr m/feste | 07-200-224K | 2 |

Se separat delmontering for detaljer
 See separate assembly for details
 Se separata delmontering för detaljer

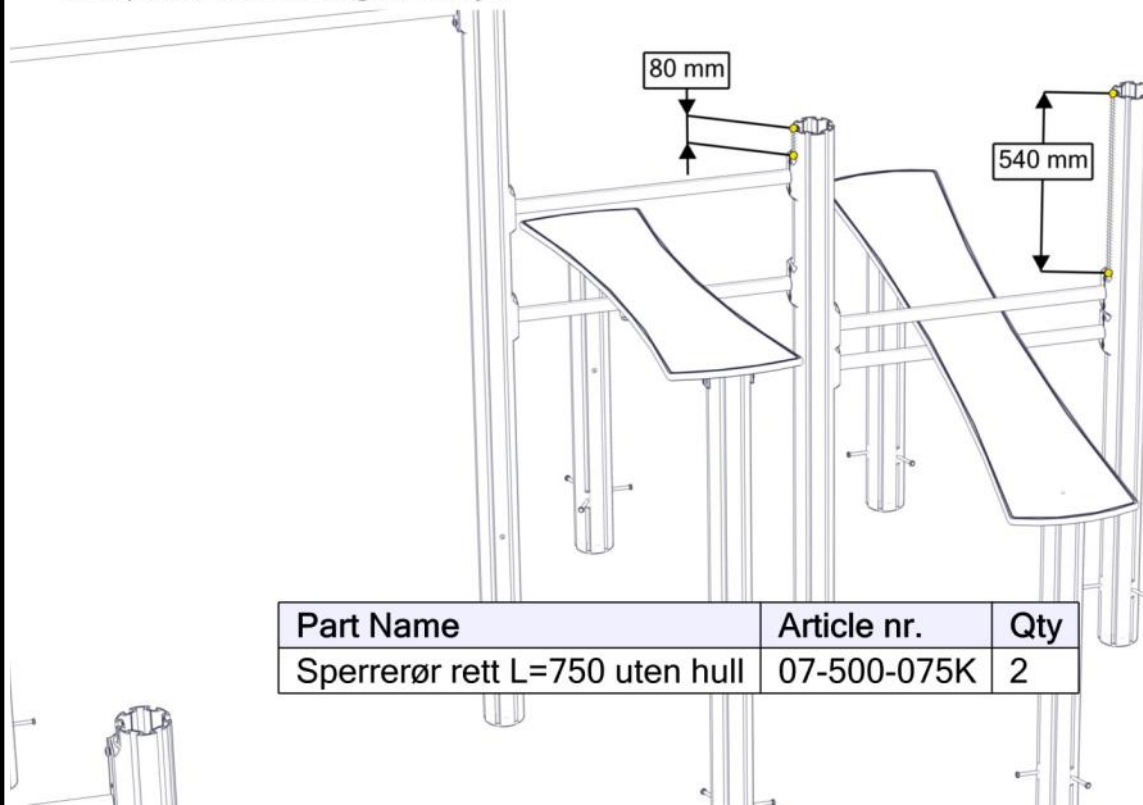



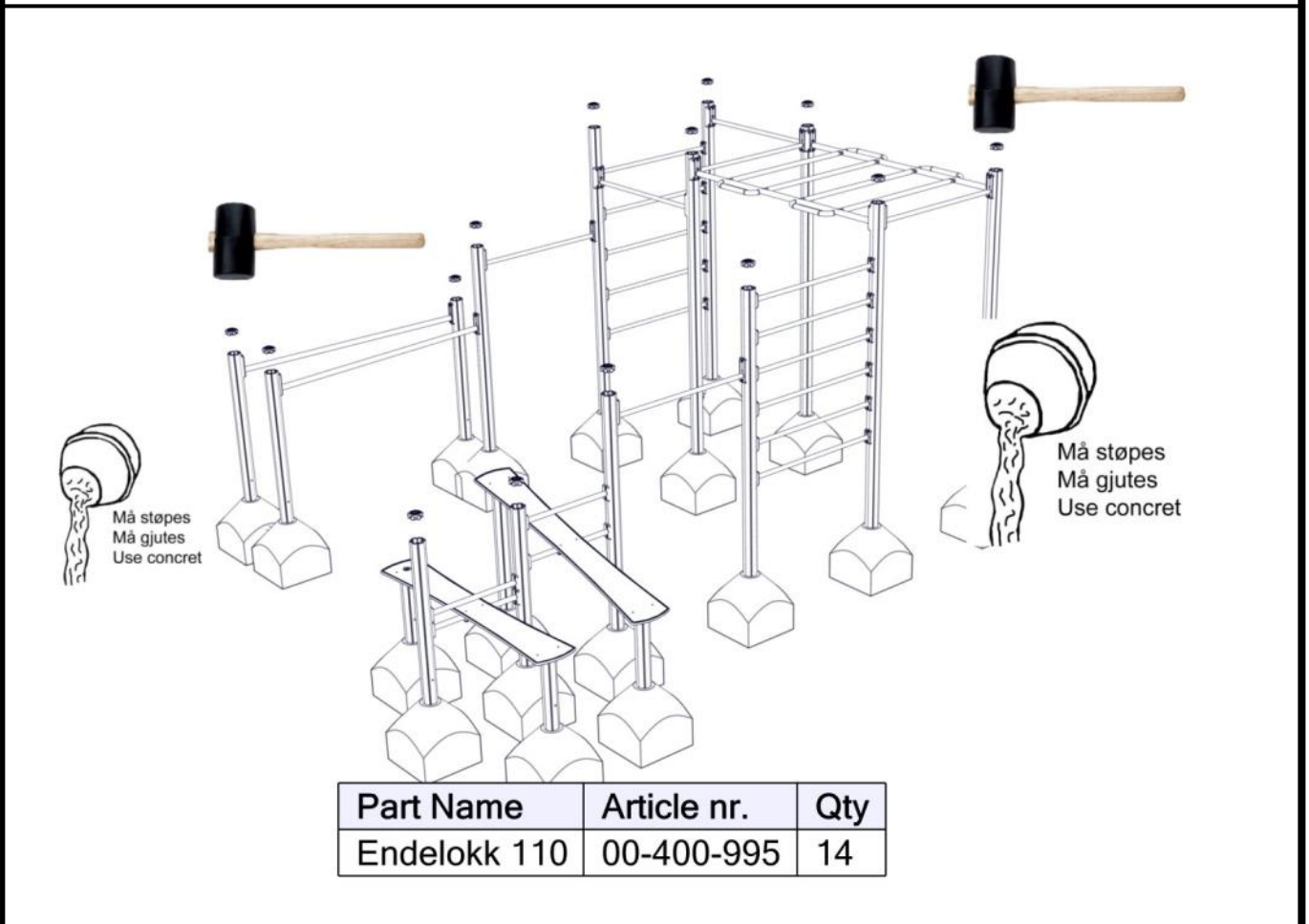
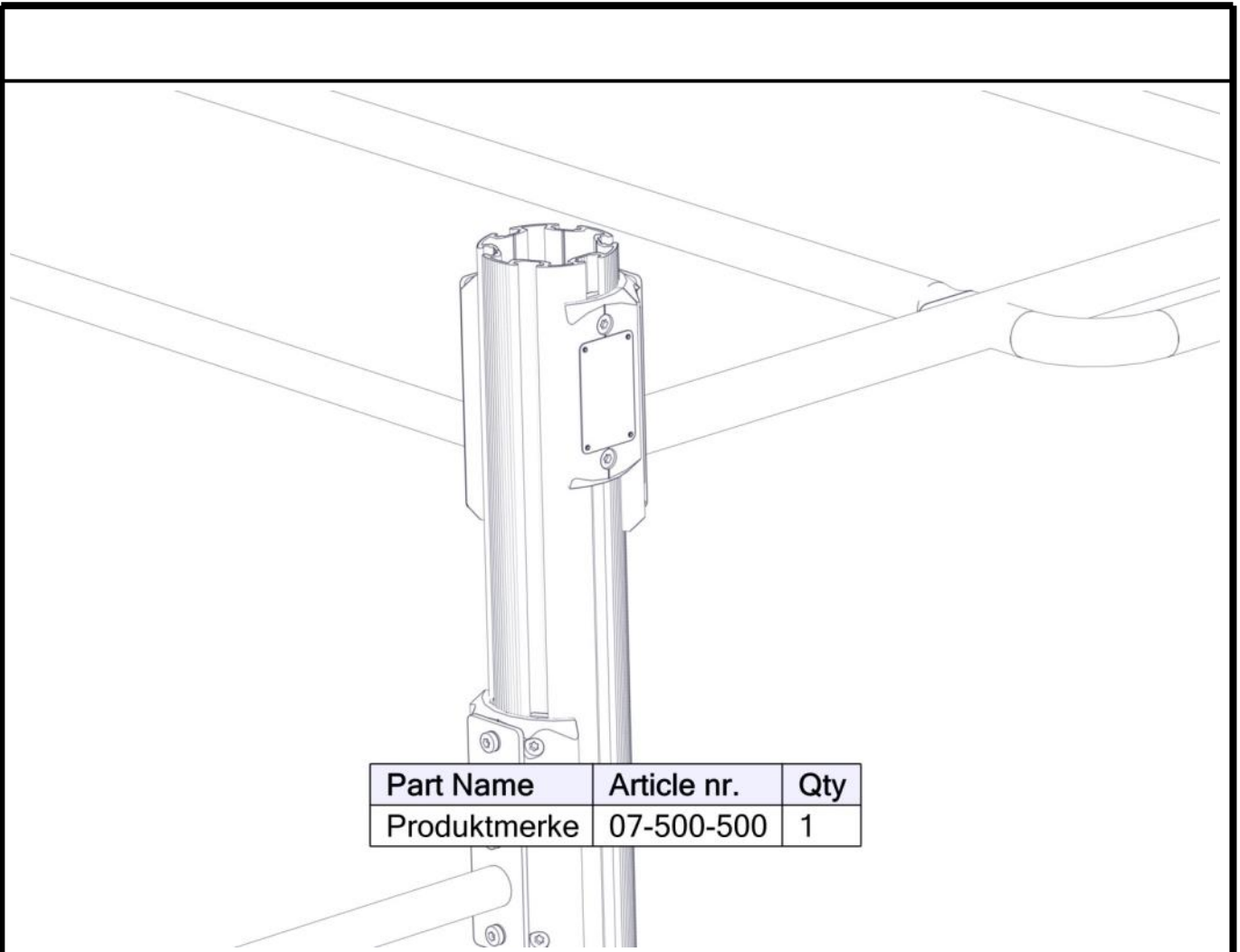



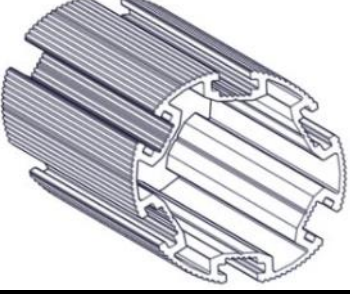
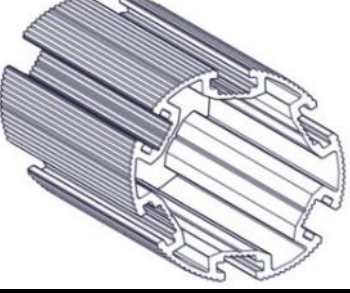
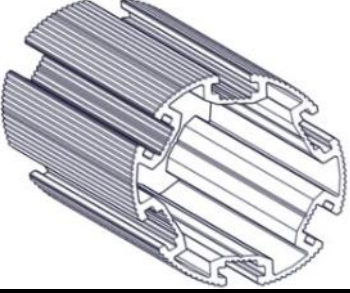
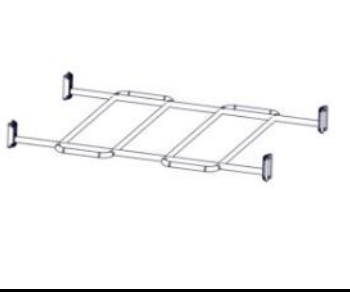
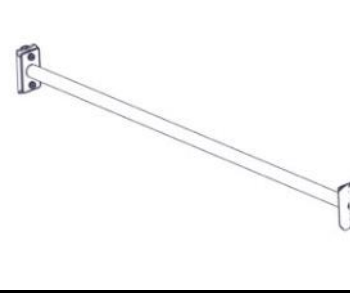
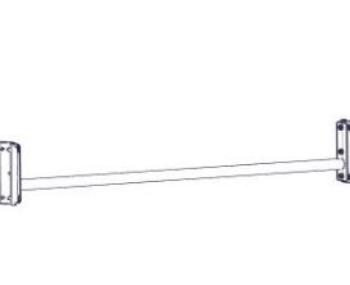





| Part Name | Article nr. | Qty |
|--------------------------------|-------------|-----|
| Sperrerør rett L=750 uten hull | 07-500-075K | 2 |



| Før utstyret tas i bruk / Before play begins / Innan lekredskapet tas i bruk | |
|---|---|
| N | <ul style="list-style-type: none"> ● Påse at fallunderlag er utlagt i henhold til gjeldende regler eller vår anbefaling ● Fjern alle monteringshjelpemidler (rester av betong, planker, paller, plast, og lignende) ● Før utstyret tas i bruk, burde man sjekke at det ikke er fare for at anorakksnorer og lignende som kan hekte seg fast noen steder på lekeapparatet. (Vedlagte snor med dobbe (kneledd) kan brukes til å sjekke at dette er i orden. Se vedlagte veiledning for bruk av denne. Dette gjøres for å oppdage eventuelle feilmonteringer.? ● NB! Bør stå i 2-3 dager før bruk |
| EN | <ul style="list-style-type: none"> ● Make sure the area and depth of safer surfacing are according to the current standard, or to the manufacturer's recommendation ● Make sure all tools and surplus materials are removed before play begins ● PS! When complete, allow 2-3 days for the concrete to set before use |
| S | <ul style="list-style-type: none"> ● Kontrollera att fallunderlag är utlagt enligt gällande regler eller vårt rekommendation ● Ta bort alla monteringshjälpmedel (rester av betong, plankor, pallar, plast och liknande) ● Innan lekredskapet används, kontrollera att anoracksnoddar eller kläder/delar av kläder eller liknande inte kan fastna i några delar på redskapet. (Den bipackade "knävringen" kan man med fördel användas för denna kontroll. ● Detta görs för att upptäcka eventuella felmonteringar.) |

| Boltepakker for / Boltpackage for / Bultpaket för | | Sign. _____ | | |
|---|---|--|------------|------------|
| Sort-Grå 16-101-385 | Navn | Artnr/ dimensjon | Ant | Lev |
|  | Stolpe Ø110 L=3250 (2650-600) | SFA5126/2 | 6 | |
| | Stolpe Ø110 L=2850 (2250-600) | SFA5126/2 | 1 | |
| | Stolpe Ø110 L=2400 (1800-600) Grå | SFA5126/2 | 1 | |
|  | Stolpe Ø110 L=2350 (1750-600) | SFA5126/2 | 1 | |
| | Stolpe Ø110 L=1800 (1200-600) | SFA5126/2 | 3 | |
| | Stolpe Ø110 L=1700 (1100-600) Grå | SFA5126/2 | 2 | |
|  | Stolpe Ø110 L=1508 skrå (908-600) | 07-100-361 | 1 | |
| | Stolpe Ø110 L=1040 skrå (440-600) | 07-100-363 | 1 | |
| | Stolpe Ø110 L=1000 (400-600) Grå | SFA5126/2 | 2 | |
|  | Workoutbro inkl 30gr beslag Sort | 07-200-175K (Se egen del- montering) | 1 | |
|  | Workout rør cc1400 0gr Sort | 07-200-164K (Se egen del- montering) | 11 | |
|  | Workout rør L=1270mm 30gr 200 Beslag Sort | 07-200-166K (Se egen del- montering) | 2 | |

| Boltepakker for / Boltpackage for / Bultpaket för | | Sign. _____ | | |
|---|--|--|------------|------------|
| Sort-Grå 16-101-385 | Navn | Artnr/ dimensjon | Ant | Lev |
|  | Workout rør Ø33 L=1270 0gr Sort | 07-200-165K (Se egen del- montering) | 4 | |
|  | Sperrerør rett workout 30gr beslag cc650 Sort | 07-500-081K (Se egen del- montering) | 1 | |
|  | Sperrerør rett workout 30gr beslag cc400 Sort | 07-500-082K (Se egen del- montering) | 1 | |
|  | Workout rør 0gr Ø44,5 L=2160 CC400-650 Venstre Sort | 07-200-183K (Se egen del- montering) | 1 | |
|  | Workout rør 0gr Ø44,5 L=2160 CC400-650 Høyre Sort | 07-200-182K (Se egen del- montering) | 1 | |
|  | Sperrerør 0gr sittebrett L=750 Sort | 07-200-128K (Se egen del- montering) | 1 | |

| Boltepakker for / Boltpackage for / Bultpaket för | | Sign. _____ | | |
|---|---|--|------------|------------|
| Sort-Grå 16-101-385 | Navn | Artnr/ dimensjon | Ant | Lev |
|  | Sperrerør med 15gr beslag, sittebrett L=750 Sort | 07-200-129K (Se egen del- montering) | 1 | |
|  | Sittup Brett med gummi m/feste | 07-200-224K (Se egen del- montering) | 2 | |
|  | Sperrerør rett uten hull Komplett L=750 Sort | 07-500-075K (Se egen del- montering) | 2 | |
|  | Produktmerke | 07-500-500 | 1 | |
|  | Endelokk til stolpe Ø110 | 00-400-995 | 14 | |
|  | Fotfeste trening | 30-490-100K (Se egen del- montering) | 1 | |

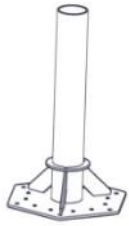
| Boltepakker for / Boltpackage for / Bultpaket för | | Sign. _____ | | |
|---|---|--|------|-----|
| Sort-Grå 16-101-385 | Navn | Artnr/ dimensjon | Ant | Lev |
| | Støp fundament | | | |
|  | Fundament betong Ø110 | 00-003-111K (Se egen del- montering) | 18 | |
| | | | | |
| | Overflate montering | | | |
|  | Fundament 1xØ110 for Betongdekk Ekstra | 00-003-137K (se egen del- montering) | 12 | |
| | Fundament 1xØ110 for Betongdekk Ekstra KORT For situp Brett | 00-003-151K (se egen del- montering) | 6 | |
| | Stolpe må kappes | SFA5126/2 | (18) | |