

N

**Monteringsanvisning**

EN

**Assembly Instructions**

S

**Monteringsanvisning**

Produkt nr. / Product no. / Produkt nr.

**81-201-260****Sort / Grå**

Ord. nr. \_\_\_\_\_

Dato. \_\_\_\_\_

Sign. \_\_\_\_\_

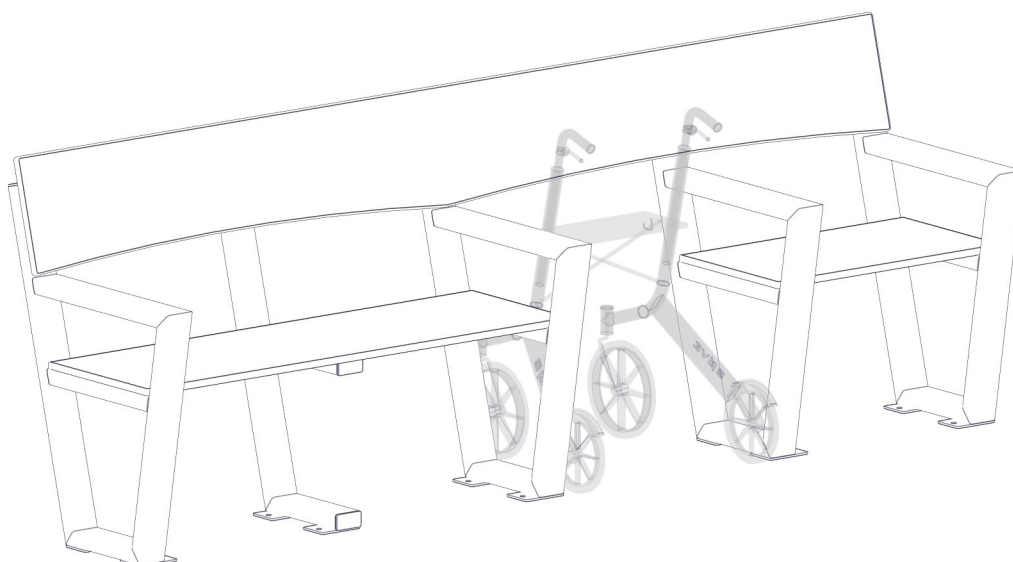

Outdoor furniture for contact use  
Sittemøbler og bord for allmenn bruk

**søve**

Søve AS  
Grønnvoldveien 290  
3830 Ulefoss - Norway  
Tlf: +47 35 94 65 65  
www.sove.no



Søve AB  
EA Rosengrensgatan 32  
421 31 Västra Frölunda  
Phone: +46 (0)31 773 97 00  
www.sove.se

## Monteringstips / Assembly Advice / Monteringsstips

**N**

- Les monteringsanvisningen nøye før montering.
- Monter elementene i rekkefølgen som vist.
- Boltene bør ikke skrues for hardt til før alt er montert, vatret og loddet. Skru så boltene til.
- NB! Ved bruk av drill, kan boltene ryke.
- Er lekeutstyret plassert i naturlige ferdselstraséer må området sikres mot gjennomgang.
- Innspringningshinder bør vurderes rundt lekeapparater hvor det er stor bevegelse, f.eks. ved huskestativ.
- Det bør være fritt innsyn til lekeutstyr som er beregnet for barn under 3 år.

**NB! Under monteringsarbeidet må utstyr, som ikke er forankret forsvarlig i bakken, sikres slik at det ikke velte.**

**Området må avstenges under montering av apparatene med sperrebånd eller lignende.**

**EN**

- Read the instruction carefully before assembling the play unit..
- Assemble the components in the sequence shown in these instructions.
- Fixings must not be fully tightened during assembly. Before casting the foundations, the structure must be level and plumb, at which point all fixings are tightened.
- PS! If use of drill, the bolts may be wrecked.
- Secure the construction-area to prevent people from walking through it.
- Consider installing barriers around play-equipment which gives rise to a lot of activity – i.e.swings.
- Ensure that clear vision is possible across the play area so that supervision is possible from any position, particularly where children under 3 years of age will be playing.

**NB! During assembly of the equipment, ensure that all structures are securely propped, especially when left overnight. Also ensure that equipment is supported whilst concrete foundations are setting and enclose the area securely to prevent access.**

## Monteringstips / Assembly Advice / Monteringsstips

**S**

- Läs monteringsanvisningen noga före montering.
- Montera delarna i den ordningen som anvisas
- Skruvarna bör inte skruvas för hårt tills allt är monterat, i våg och lodat.

OBS! Används elektrisk skruvdragare, kan bulten gå sönder. Hårddra därför manuellt!

- Om lekplatsen placeras vid en gångväg mm bör området säkras mot genomfart av gående och cyklister.
- Inspjängningshinder bör placeras runt lekutrustning med stor rörelse, t ex, gungställning.
- Det bör vara fri insyn till lekutrustning beräknat till barn under 3 år.

**OBS! Under monteringsarbete bör utrustningen som inte ska förankras i marken, ställs så att den inte kan välta.**

**Området måste spärras när lekutrustningen byggs upp, med avspärrningsband eller liknande.**

**N**

Alle mål er oppgitt i millimeter

**EN**







Scale measured in mm

**S**

Alla mått är i millimeter.

NO	Betongkvalitet				
SE	Betongkvalitet				
EN	Concrete quality				
NO	Mengde betong				
SE	Mängd betong		0,26 m <sup>3</sup> (0,3x0,3x0,3x10)	m <sup>3</sup>	
EN	Amount of concrete				
NO	Fundament størrelse				
SE	Stiftelsestorlek		10x 0,3x0,3x0,3	m	
EN	Foundation size				
NO	For sikkerhet må fundamentene med sand eller myk jord være minst 50% større i areal				
SE	För säkerheten måste grunden med sand eller mjuk jord vara minst 50% större i området				
EN	For safety, the foundations with sand or soft soil must be at least 50% larger in area				
NO	Tyngste element				
SE	Tyngsta element	08-003-225	19	Kg	
EN	Heaviest element				
NO	Største element				
SE	Största element	08-003-225	2,7x0,3x0,01	m	
EN	Biggest element				

**Nødvendig verktøy / Tools required / Nödvändiga verktyg**

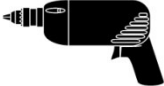
<p>(N)</p> <p>(EN)</p> <p>(S)</p>	<p>(A)</p> 	<p>(B)</p>  <p>Torx Nr 45 High quality</p>	<p>6mm</p> 	<p>(D)</p> 	
		<p>Metermål</p> <p>Metric measure</p> <p>Tumstock</p> 	<p>Ø11mm Bor</p> <p>Ø11mm Drill</p> <p>Ø11mm Borr</p> 		

**Nødvendig antall personer / Number of persons required / Rekommenderad antal personer**





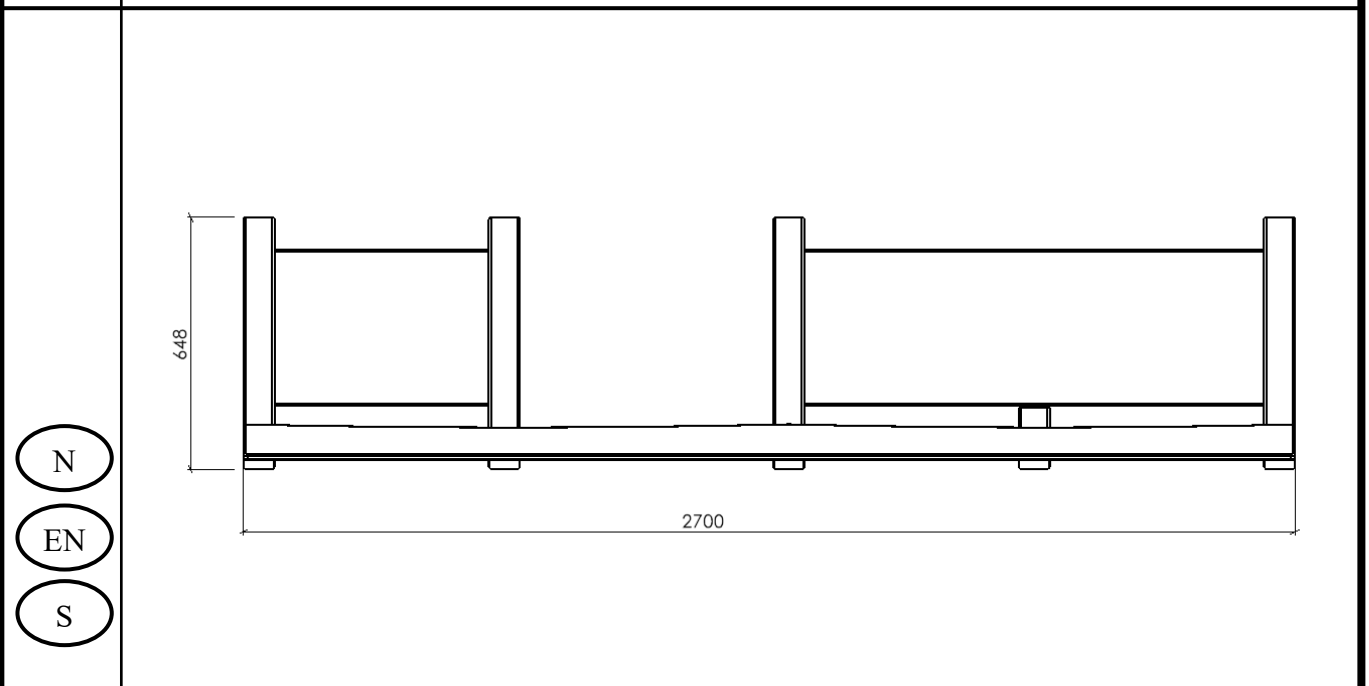

**Anbefalt arealbehov ved montering / Recommended working space / Rekommenderad arealbehov vid montering**



**Boltepakker for / Boltpackage for / Bultpaket för**

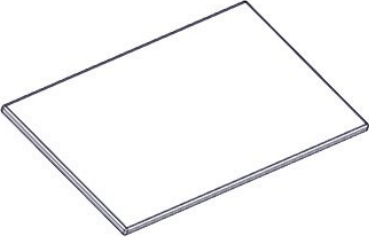
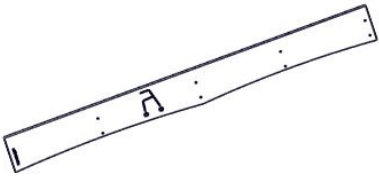
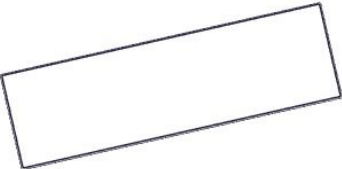

Sign. \_\_\_\_\_

81-201-260, Grå Seniorbenk 4R,	Navn	Artnr/dimensjon	Ant	Lev
	Senior frame høyre inkl. sort	08-003-160K	2	
	Senior frame venstre inkl. sort	08-003-161K	2	
	Seniorbenk sete 1 Grå	08-003-125	1	
	Seniorbenk rygg 2R1 Grå	08-003-225	1	
	Seniorbenk sete 2 Grå	08-003-135	1	
	Produktmerke montert hos Søve	00-100-401	0	

**Boltepakker for / Boltpackage for / Bultpaket för**

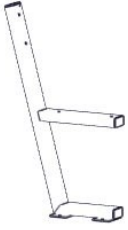
Sign. \_\_\_\_\_.

81-201-260, Grå Seniorbenk 4R,	Navn	Artnr/dimensjon	Ant	Lev
	Senior frame midt inkl. sort	08-003-162K	1	

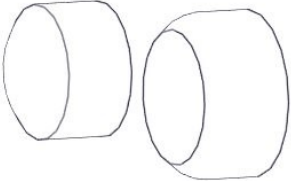
Boltepakker for / Boltpackage for / Bultpaket för		Sign. _____		
81-201-260, Grå Seniorbenk 4R,	Navn	Artnr/dimensjon	Ant	Lev
	<b>Fundament Støp</b>			
	Støp forankring Parkmøbler Søve	08-001-091K (se egen delmontering)	10	
	<b>Fundament Nedgravning</b>			
	Støpefri forankring Parkmøbler Søve	08-001-090K (se egen delmontering)	10	
	<b>Overflate montering</b>			
	Endedeksel flat M10/M12 med skive  Forankrings bolter er IKKE levert fra Søve	05-301-035	10	



**Fundamentering med betong / Foundation with concrete / Förankring medd betong**

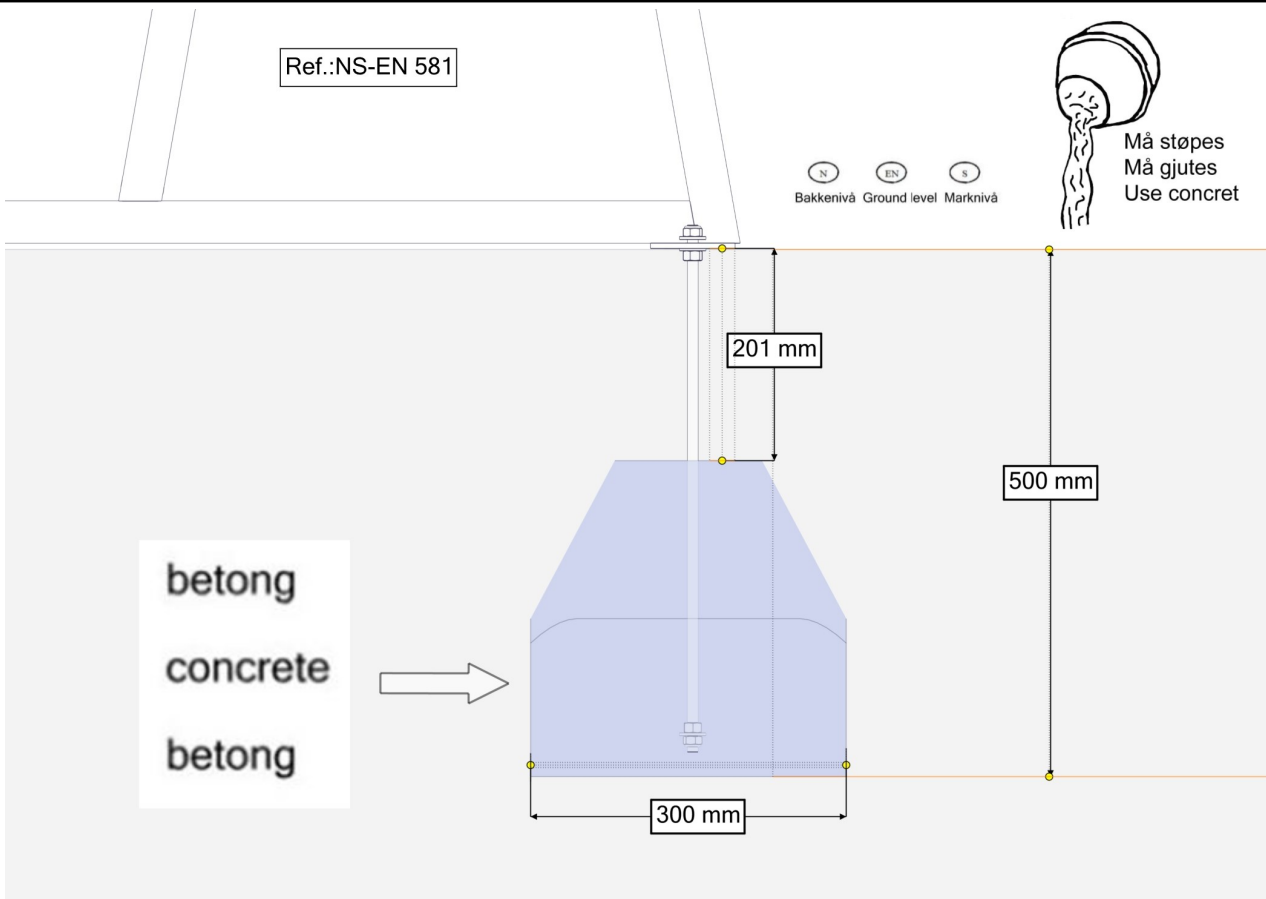

**Fundamentering uten betong / Foundation without concrete / Förankring utan betong**

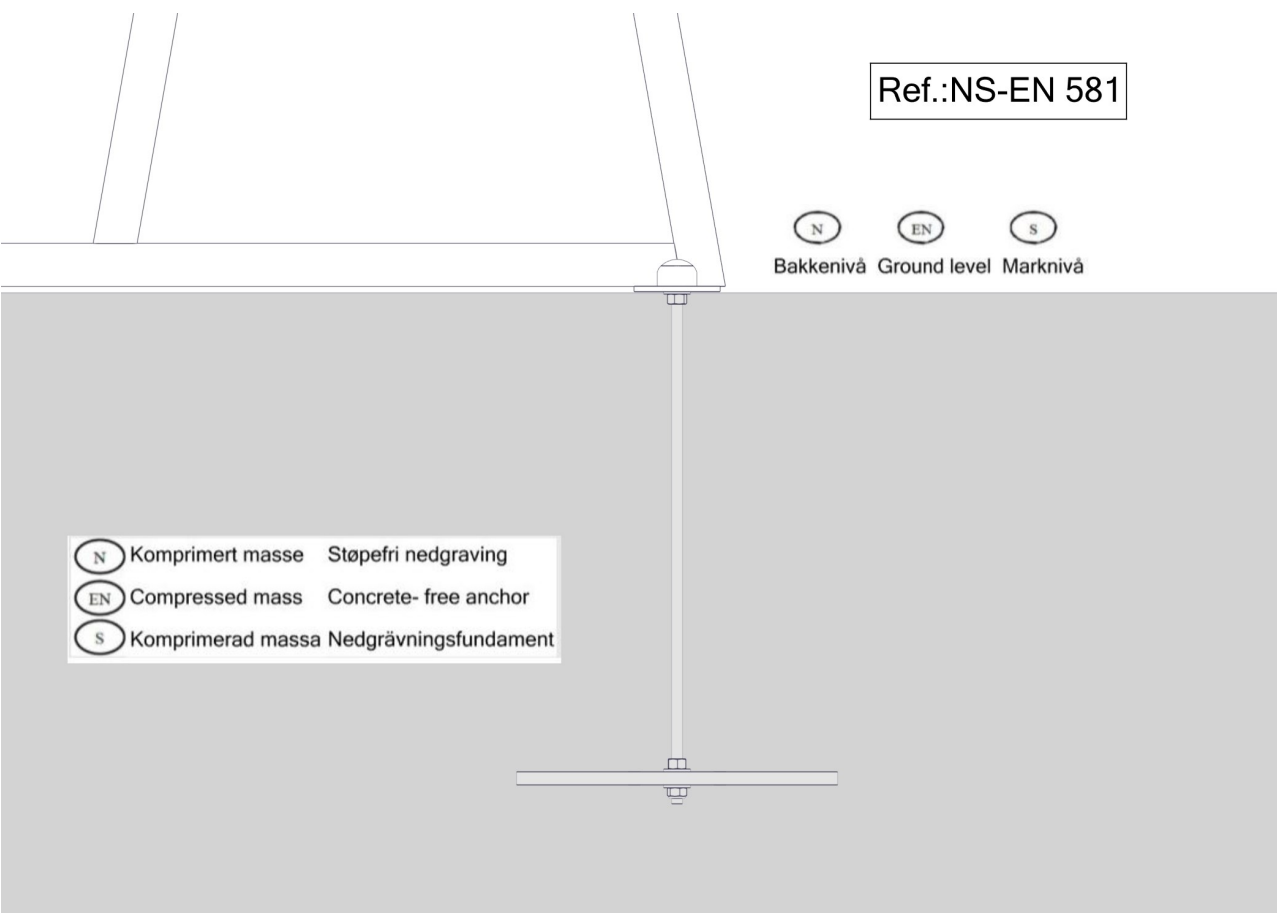

# Fundamentering overflate/ Foundation surface/ Förankring grundytan

Må boltes  
Must be bolted  
Måste skruvas fast

Ref.:NS-EN 581

(N) (EN) (S)  
Bakkenivå Ground level Marknivå

Minimum M12x150

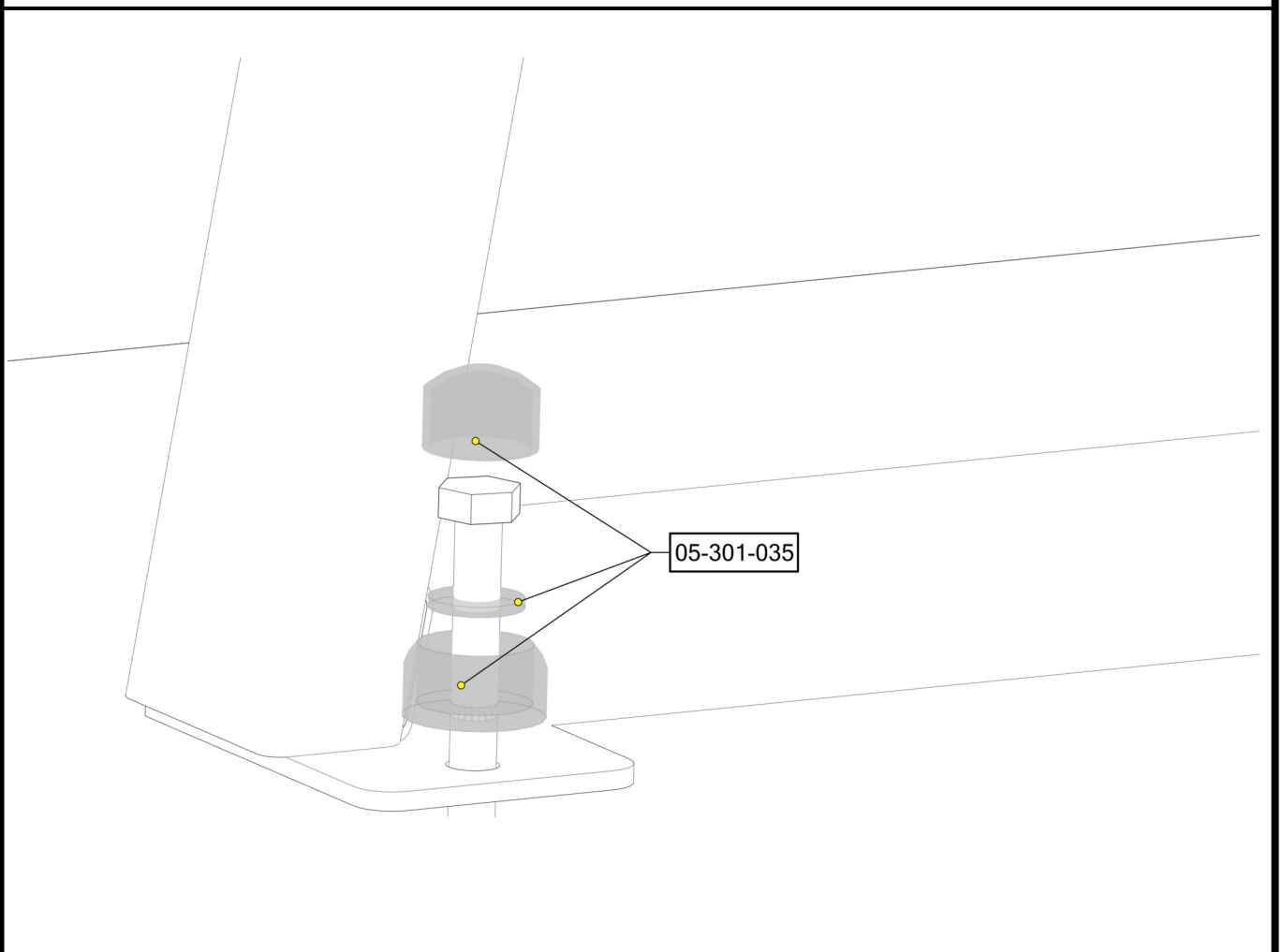

**Plassering av forankringer / Ground plan / Placering av förankringar**

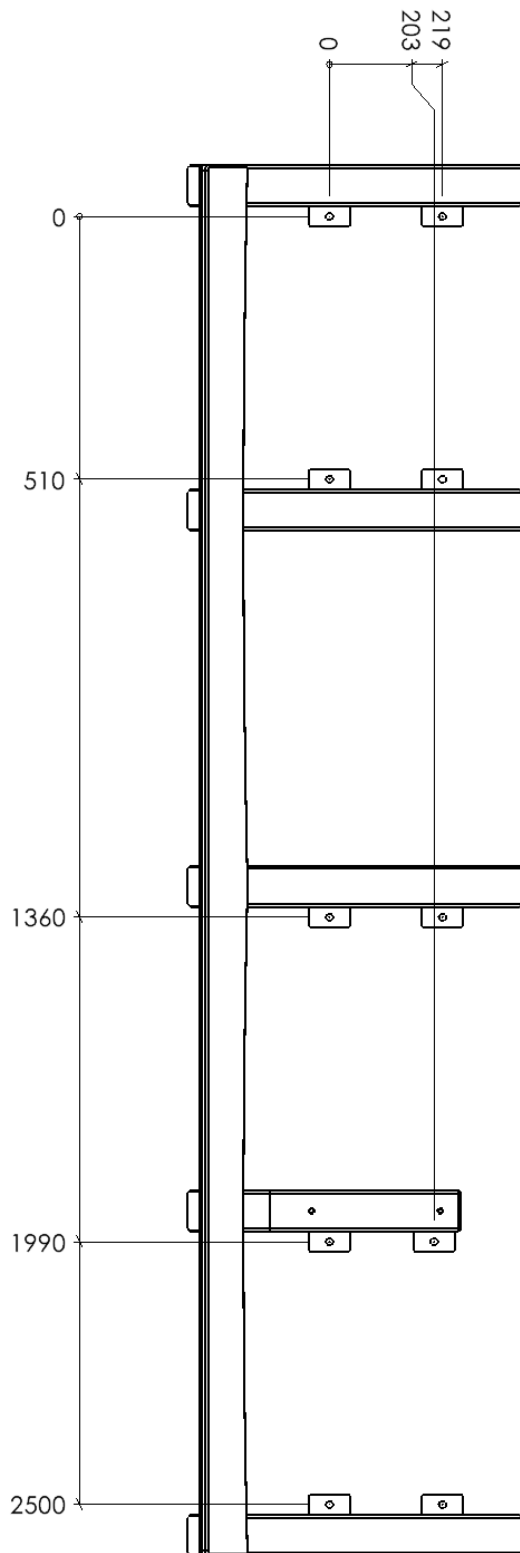

## Montering av lekeapparatet / Assembly instructions / Montering av lekredskapet

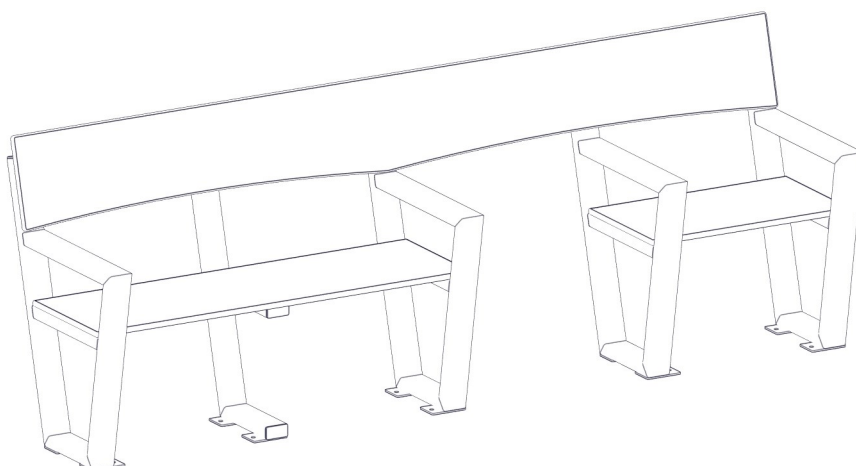

PartName	Artnr	Antall
SeniorBenk1_Inserts	08-003-125	1
SeniorBenk2_Inserts	08-003-135	1
Senior_frame høyre-Sort_inkl	08-003-160K	2
Senior_frame venstre-Sort_inkl	08-003-161K	2

PartName	Artnr	Antall
Senior_frame midt-Sort_inkl	08-003-162K	1
SeniorRygg_Inserts-2R1	08-003-225	1

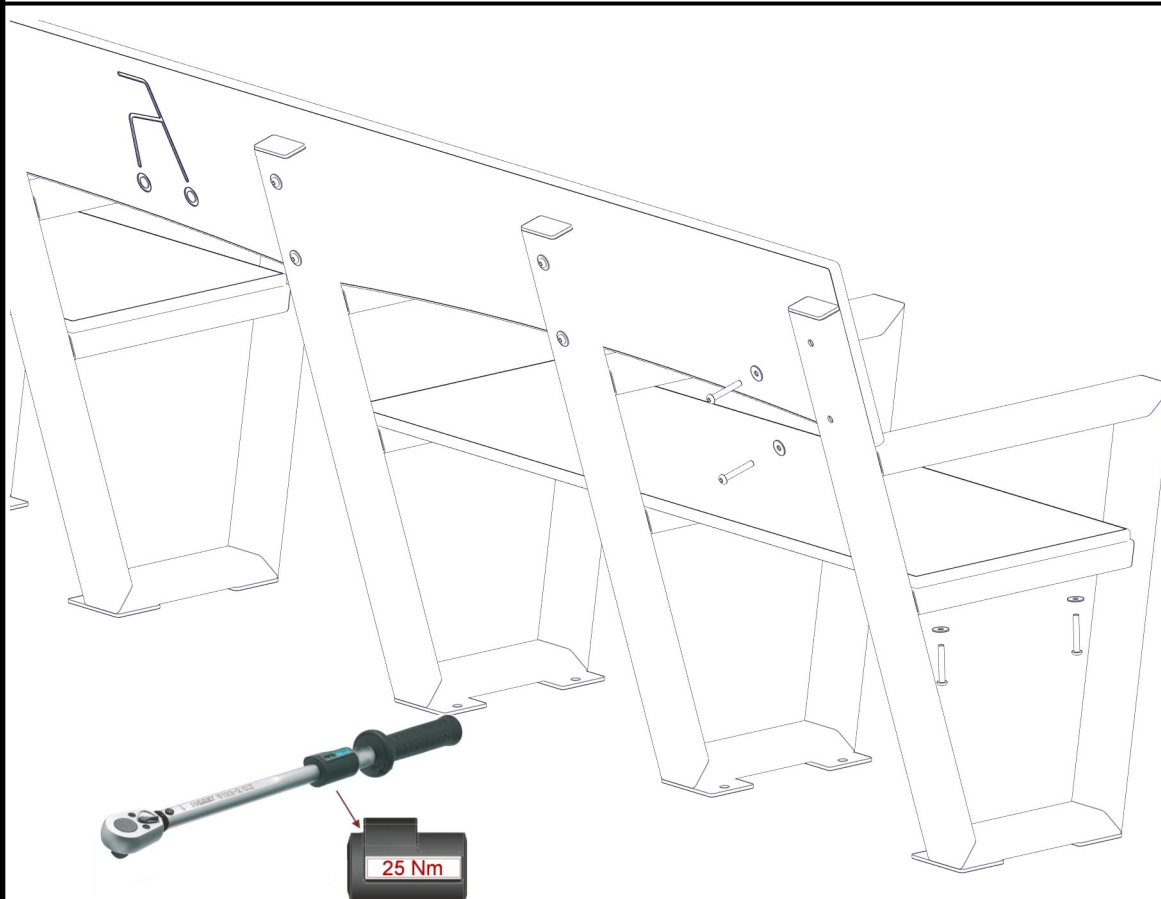





<b>Før utstyret tas i bruk / Before play begins / Innan lekredskapet tas i bruk</b>	
<b>N</b>	<ul style="list-style-type: none"> <li>● Påse at fallunderlag er utlagt i henhold til gjeldende regler eller vår anbefaling</li> <li>● Fjern alle monteringshjelpemidler ( rester av betong, planker, paller, plast, og lignende)</li> <li>● Før utstyret tas i bruk, burde man sjekke at det ikke er fare for at anorakksnorer og lignende som kan hekte seg fast noen steder på lekeapparatet. (Vedlagte snor med dobbe (kneledd) kan brukes til å sjekke at dette er i orden. Se vedlagte veiledning for bruk av denne. Dette gjøres for å oppdage eventuelle feilmonteringer.?)</li> <li>● NB! Bør stå i 2-3 dager før bruk</li> </ul>
<b>EN</b>	<ul style="list-style-type: none"> <li>● Make sure the area and depth of safer surfacing are according to the current standard, or to the manufacturer's recommendation</li> <li>● Make sure all tools and surplus materials are removed before play begins</li> <li>● PS! When complete, allow 2-3 days for the concrete to set before use</li> </ul>
<b>S</b>	<ul style="list-style-type: none"> <li>● Kontrollera att fallunderlag är utlagt enligt gällande regler eller vårt rekommendation</li> <li>● Ta bort alla monteringshjälpmedel (rester av betong, plankor, pallar, plast och liknande)</li> <li>● Innan lekredskapet används, kontrollera att anoracksnoddar eller kläder/delar av kläder eller liknande inte kan fastna i några delar på redskapet. (Den bipackade "knävringen" kan man med fördel användas för denna kontroll.</li> <li>● Detta görs för att upptäcka eventuella felmonteringar.)</li> </ul>

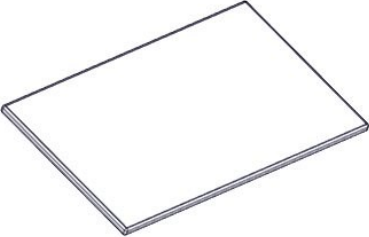
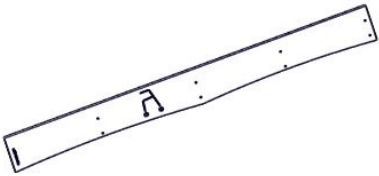
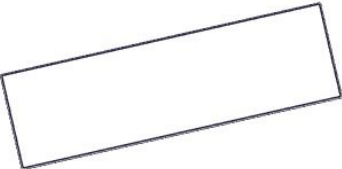

**Boltepakker for / Boltpackage for / Bultpaket för**

Sign. \_\_\_\_\_



81-201-260, Grå Seniorbenk 4R,	Navn	Artnr/dimensjon	Ant	Lev
	Senior frame høyre inkl. sort	08-003-160K	2	
	Senior frame venstre inkl. sort	08-003-161K	2	
	Seniorbenk sete 1 Grå	08-003-125	1	
	Seniorbenk rygg 2R1 Grå	08-003-225	1	
	Seniorbenk sete 2 Grå	08-003-135	1	
	Produktmerke montert hos Søve	00-100-401	0	

**Boltepakker for / Boltpackage for / Bultpaket för**

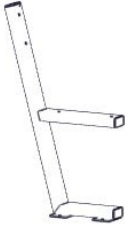
Sign. \_\_\_\_\_.

81-201-260, Grå Seniorbenk 4R,	Navn	Artnr/dimensjon	Ant	Lev
	Senior frame midt inkl. sort	08-003-162K	1	

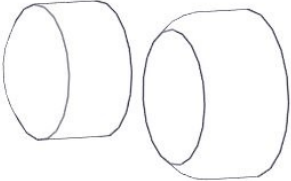

Boltepakker for / Boltpackage for / Bultpaket för		Sign. _____		
81-201-260, Grå Seniorbenk 4R,	Navn	Artnr/dimensjon	Ant	Lev
	<b>Fundament Støp</b>			
	Støp forankring Parkmøbler Søve	08-001-091K (se egen delmontering)	10	
	<b>Fundament Nedgravning</b>			
	Støpefri forankring Parkmøbler Søve	08-001-090K (se egen delmontering)	10	
	<b>Overflate montering</b>			
	Endedeksel flat M10/M12 med skive  Forankrings bolter er IKKE levert fra Søve	05-301-035	10	