

N

**Monteringsanvisning**

EN

**Assembly Instructions**

S

**Monteringsanvisning**

Produkt nr. / Product no. / Produkt nr.

**61-200-700****Trestruktur**

Ord. nr. \_\_\_\_\_

Dato. \_\_\_\_\_

Sign. \_\_\_\_\_

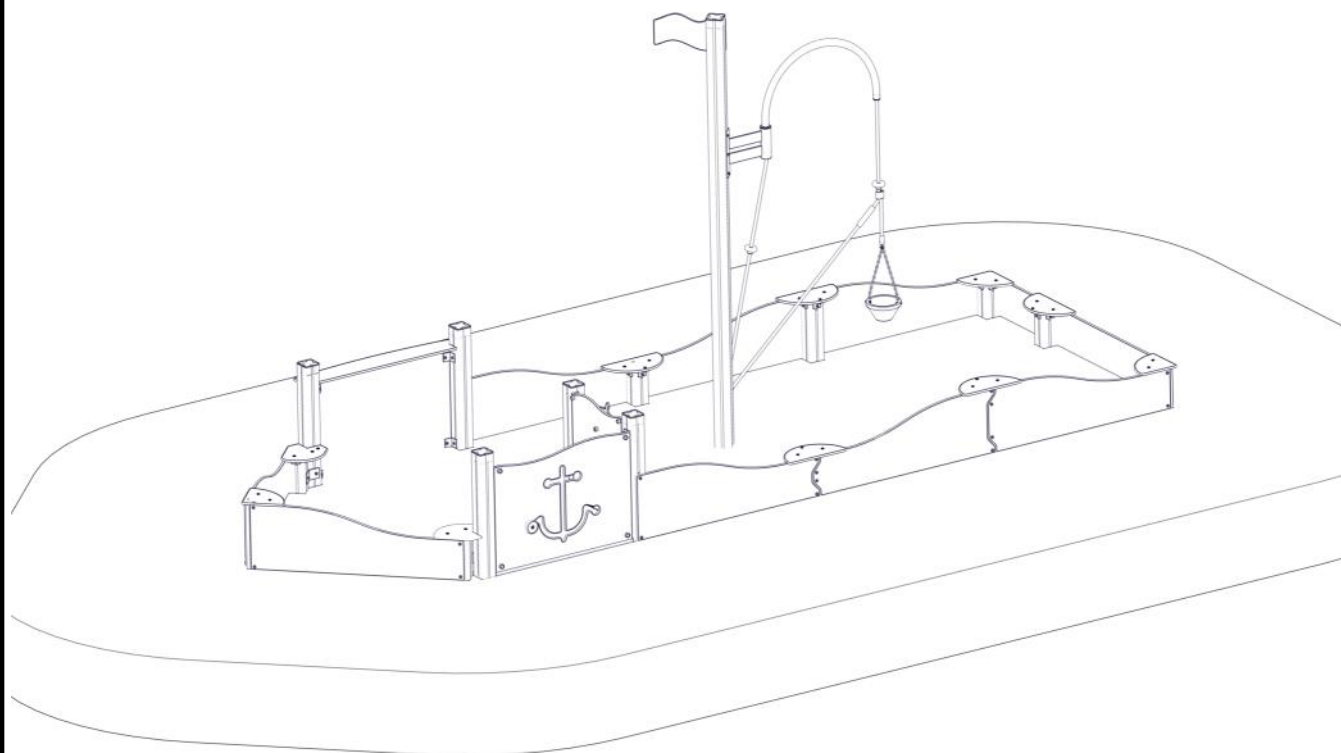
**søve**

Søve AS  
Grønnvoldveien 290  
3830 Ulefoss - Norway  
Tlf: +47 35 94 65 65  
www.sove.no



Søve AB  
EA Rosengrensgatan 32  
421 31 Västra Frölunda  
Phone: +46 (0)31 773 97 00  
www.sove.se

## Monteringstips / Assembly Advice / Monteringsstips

N

- Les monteringsanvisningen nøye før montering.

- Monter elementene i rekkefølgen som vist.
- Boltene bør ikke skrues for hardt til før alt er montert, vatret og loddet. Skru så boltene til.
- NB! Ved bruk av drill, kan boltene ryke.
- På grunn av at solen kan gjøre rutsjeflaten veldig varm, bør rutsjebanens utløp vende mot nord-øst eller nord-vest.
- Er lekeutstyret plassert i naturlige ferdselstraséer må området sikres mot gjennomgang.
- Innspringningshinder bør vurderes rundt lekeapparater hvor det er stor bevegelse, f.eks. ved huskestativ.
- Det bør være fritt innsyn til lekeutstyr som er beregnet for barn under 3 år.

**NB! Under monteringsarbeidet må utstyr, som ikke er forankret forsvarlig i bakken, sikres slik at det ikke velte.**

**Området må avstenges under montering av apparatene med sperrebånd eller lignende.**

EN

- Read the instruction carefully before assembling the play unit.

- Assemble the components in the sequence shown in these instructions. Fixings must not be fully tightened during assembly. Before casting the foundations, the structure must be level and plumb, at which point all fixings are tightened. PS! If use of drill, the bolts may be wrecked.
- Avoid positioning the slide facing due south because of overheating – ideal positions are facing north-east or north-west. Secure the construction-area to prevent people from walking through it.
- Consider installing barriers around play-equipment which gives rise to a lot of activity – i.e.swings.
- Ensure that clear vision is possible across the play area so that supervision is possible from any position, particularly where children under 3 years of age will be playing.

**NB! During assembly of the equipment, ensure that all structures are securely propped, especially when left overnight. Also ensure that equipment is supported**

**Monteringstips / Assembly Advice / Monteringsstips****S**

- Läs monteringsanvisningen noga före montering.

- Montera delarna i den ordningen som anvisas
- Skruvarna bör inte skruvas för hårt tills allt är monterat, i våg och lodat.







OBS! Används elektrisk skruvdragare, kan bulten gå sönder. Hårdra därför manuellt!

- Solen kan göra att rutchbanan blir väldigt varm. Banans nedfart rekommenderas att vändas i norrlig riktning
- Om lekplatsen placeras vid en gångväg mm bör området säkras mot genomfart av gående och cyklister.
- Insprängningshinder bör placeras runt lekutrustning med stor rörelse, t ex, gungställning.
- Det bör vara fri insyn till lekutrustning beräknat till barn under 3 år.

**OBS! Under monteringsarbete bör utrustningen som inte ska förankras i marken, ställs så att den inte kan välta.**

**Området måste spärras när lekutrustningen byggs upp, med avspärrningsband eller liknande.**

**Nødvendig verktøy / Tools required / Nödvändiga verktyg**





<p>(N)</p> <p>(EN)</p> <p>(S)</p>	<p>(A)</p> 	<p>(B)</p>  <p>Torx Nr 45</p>	<p>(C)</p> <p>5 mm 6 mm</p> 	<p>(D)</p> 	<p>(E)</p>
		<p>Metermål</p> <p>Metric measure</p> <p>Tumstock</p> 		<p>Merkebånd</p> <p>Mark ribbon</p> <p>Märkeband</p> 	



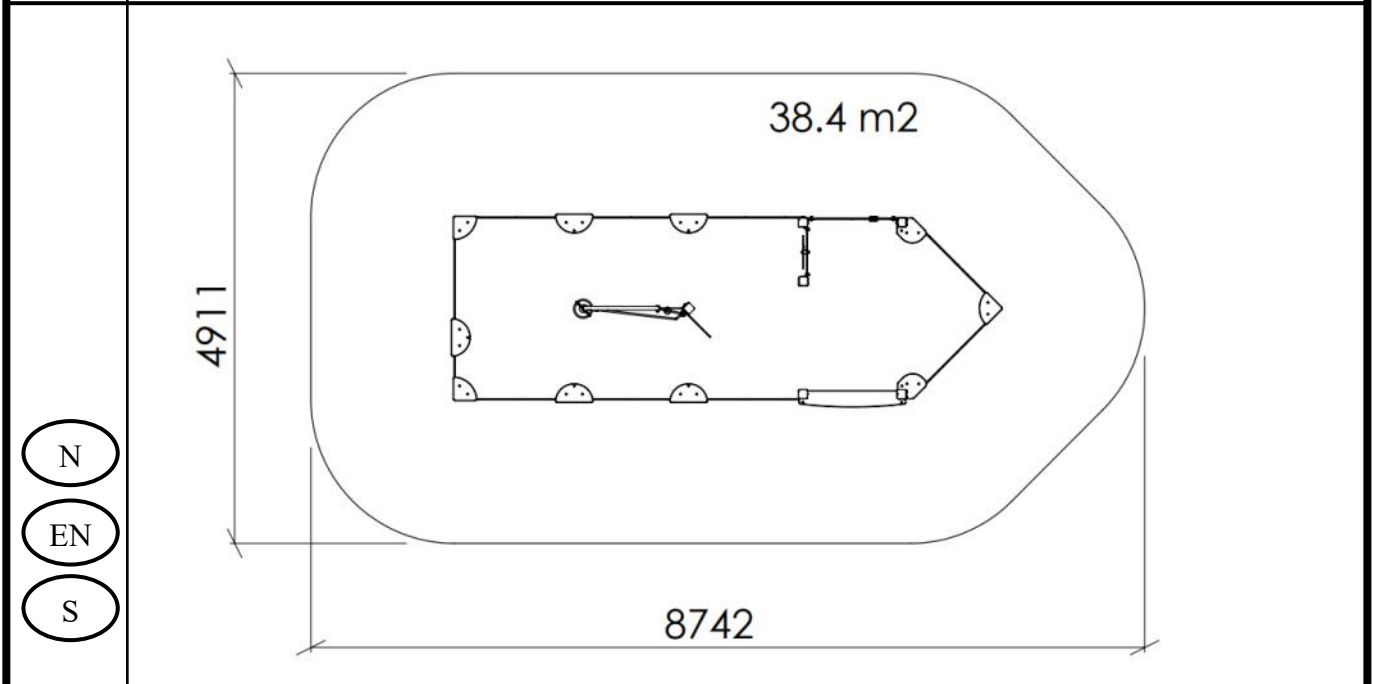

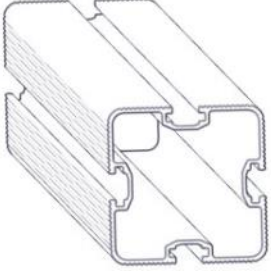
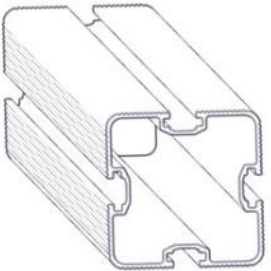
**Nødvendig antall personer / Number of persons required / Rekommenderad antal personer**

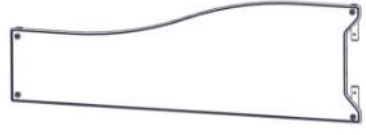

<p>(N)</p> <p>(EN)</p> <p>(S)</p>	
-----------------------------------	---

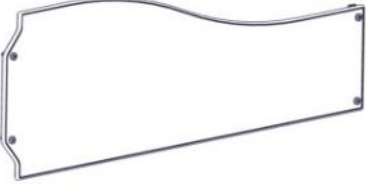

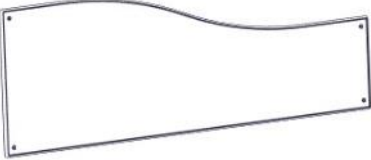

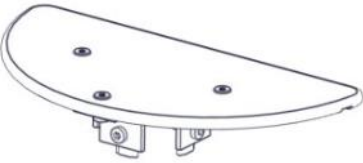
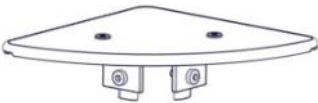
**Anbefalt arealbehov ved montering / Recommended working space / Rekommenderad arealbehov vid montering**

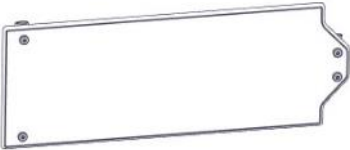
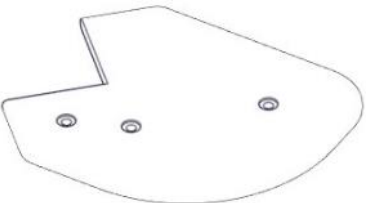
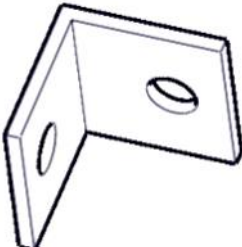

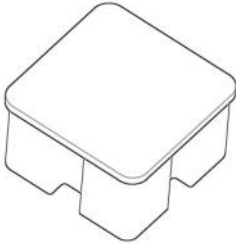
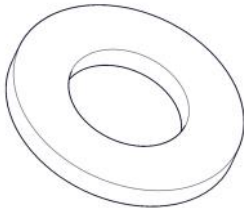
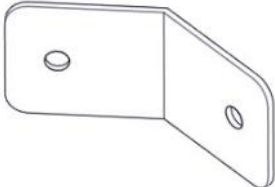

<b>Boltepakker for / Boltpackage for / Bultpaket för</b>		Sign. _____		
<b>Sandkasse båt, 61-200-700 Trestruktur</b>	<b>Navn</b>	<b>Artnr/ dimensjon</b>	<b>Ant</b>	<b>Lev</b>
	Stolpe 95 x 95 600-400 L= 1000 Sort	SFA5117/1	3	
	Stolpe 95 x 95 600-750 L= 1350 Sort	SFA5117/1	5	
	Stolpe 95 x 95 600-250 L= 850 Sort	SFA5117/1	7	
	Stolpe 95 x 95 600-2630 L= 3230 Sort	SFA5117/1	1	
	Vegg 250 male/ 400 rett 1250 x 250/400 Trestruktur	06-200-240K (se egen delmontering)	1	
	Vegg 250 rett/ 400 female 1250 x 250/400 Trestruktur	06-200-243K (se egen delmontering)	1	
	Vegg 250 male/ 400 female 1250 x 250/400 Trestruktur	06-200-244K (se egen delmontering)	1	
	Vegg 400 male/ 250 female 1250 x 250/400 Trestruktur	06-200-245K (se egen delmontering)	1	



<b>Boltepakker for / Boltpackage for / Bultpaket för</b>		Sign. _____		
<b>Sandkasse båt, 61-200-700 Trestruktur</b>	<b>Navn</b>	<b>Artnr/ dimensjon</b>	<b>Ant</b>	<b>Lev</b>
	Vegg 400 male/ 250 rett 1250 x 250/400 Trestruktur	06-200-242K (se egen delmontering)	1	
	Vegg 400 rett/ 250 female 1250 x 250/400 Trestruktur	06-200-241K (se egen delmontering)	1	
	Vegg 400 rett/ 250 rett 1250 x 250/400 Trestruktur	06-200-246K (se egen delmontering)	1	
	Vegg 400 rett/ 250 rett 1250 x 250/400 Trestruktur	06-200-247K (se egen delmontering)	1	
	Seteplate 180 grader Lyse grønn	06-200-323K (se egen delmontering)	5	
	Seteplate 90 grader Lyse grønn	06-200-313K (se egen delmontering)	3	

<b>Boltepakker for / Boltpackage for / Bultpaket för</b>		Sign. _____		
<b>Sandkasse båt, 61-200-700 Trestruktur</b>	<b>Navn</b>	<b>Artnr/ dimensjon</b>	<b>Ant</b>	<b>Lev</b>
	Sandkasse element 250 R Female L=1250 Trestruktur	06-200-250K (se egen delmontering)	1	
	Sandkasse element 250 R female L=660 Trestruktur	06-200-252K (se egen delmontering)	1	
	Seteplate 135 grader Lyse grønn	06-200-324	2	
	Vinkel alu 50x50x5 med 9mm hull	04-075-050	6	
	Produktmerke	00-100-400 (montert hos Søve)	0	

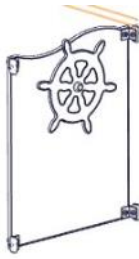
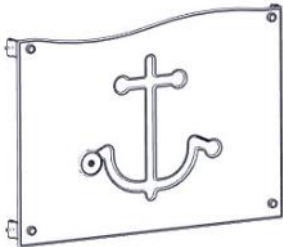
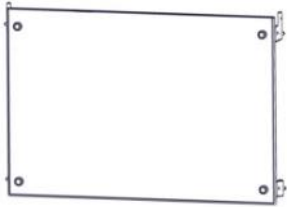
<b>Boltepakker for / Boltpackage for / Bultpaket för</b>		Sign. _____.		
<b>Sandkasse båt, 61-200-700 Trestruktur</b>	<b>Navn</b>	<b>Artnr/ dimensjon</b>	<b>Ant</b>	<b>Lev</b>
	Endelokk 95x95	00-400-998	6	
	Skive M8	04-050-008	6	
	Vinkel 135 grader	04-070-055	2	
	Torx M8x12 Torx M8x25 Torx M8x35	04-000-012 04-000-025 04-000-035	6 10 2	
	Brikke 50x8x23 1hull	04-060-050	12	
	Møbelknapp M8x11	04-030-011	6	

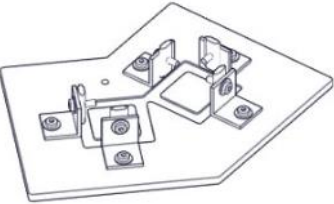

<b>Boltepakker for / Boltpackage for / Bultpaket för</b>		Sign. _____		
<b>Sandkasse båt, 61-200-700 Trestruktur</b>	<b>Navn</b>	<b>Artnr/ dimensjon</b>	<b>Ant</b>	<b>Lev</b>
	Butikdisk 1122x175 Grå	01-125-016K (se egen delmontering)	1	
	Minivegg 520x600 med ratt Trestruktur	07-510-520K (se egen delmontering)	1	
	Rekkverk 940x665x12 med spill Marine Trestruktur	01-125-114K (se egen delmontering)	1	
	Rekkverk butikdisk 940x630x12 Trestruktur	01-125-015K (se egen delmontering)	1	
	Sandkran sving med tau og ropeguide	06-200-526K (se egen delmontering)	1	
	Flagg skute	02-500-067	1	

<b>Boltepakker for / Boltpackage for / Bultpaket för</b>		Sign. _____.		
<b>Sandkasse båt, 61-200-700 Trestruktur</b>	<b>Navn</b>	<b>Artnr/ dimensjon</b>	<b>Ant</b>	<b>Lev</b>
	<b>Fundament Støp</b>			
	00-003-110K	00-003-110K	16	
	<b>Fundament Nedgravning</b>			
	00-003-110K	00-003-110K	1	
	Nedgravningsfundament 95 x 95 stolpe	00-003-004K (se egen delmontering)	11	
	Fundament til 2stk 95 stolpe	00-003-105K (se egen delmontering)	2	

**Fundamentering uten betong / Foundation without concrete / Förankring utan betong**

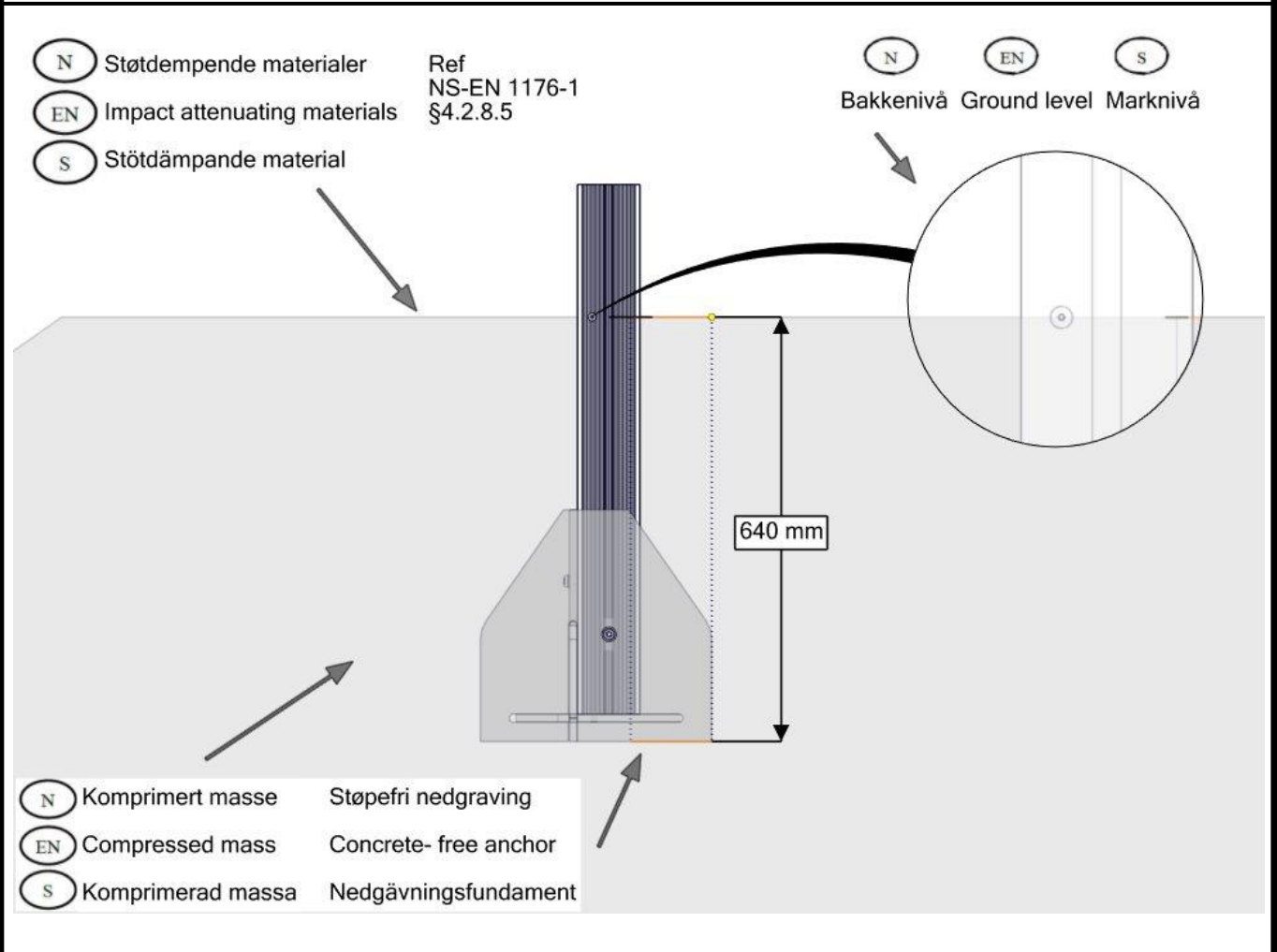

**Fundamentering med betong / Foundation with concrete / Förankring med betong**

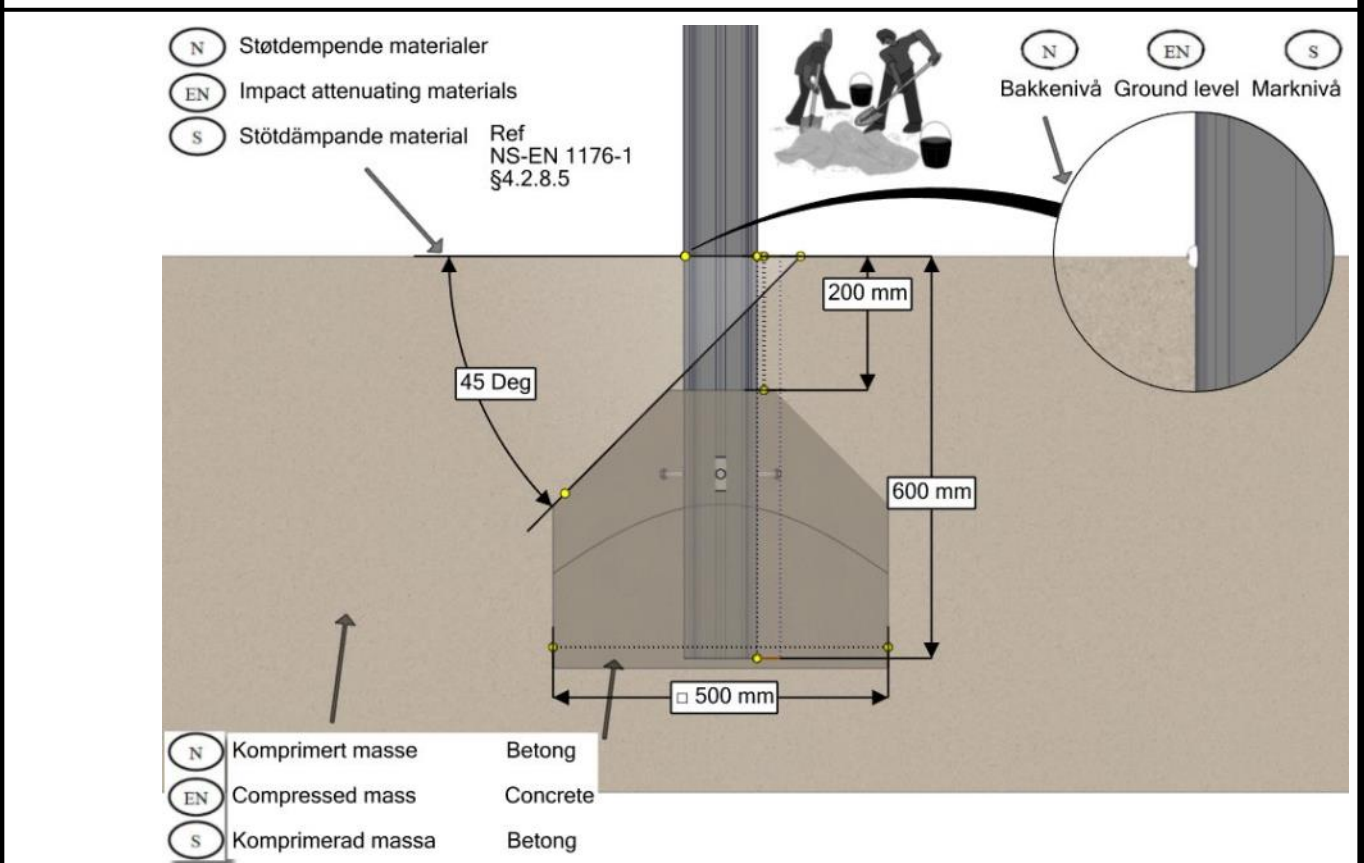

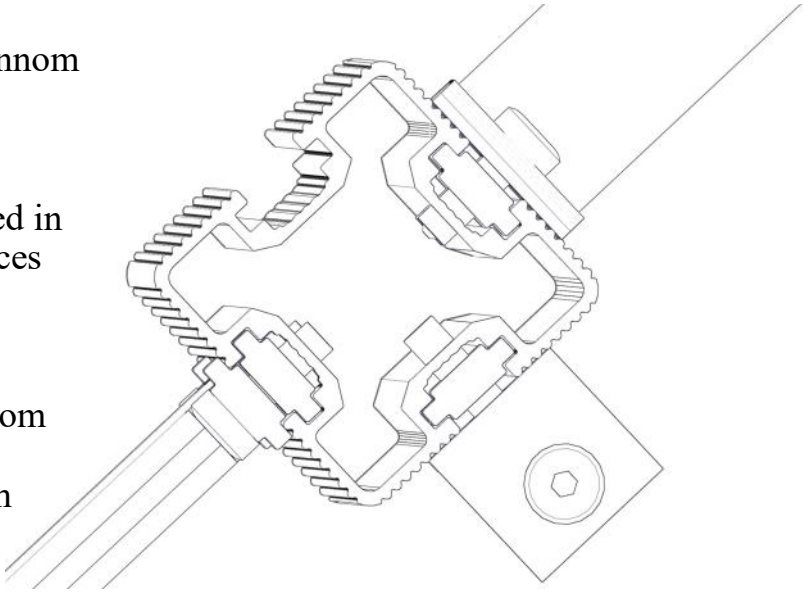
<p>(N) Bolten skrues HELT igjennom aluminiumen. Maks moment: 30Nm</p> <p>(EN) The bolt must be tightened in to the post, so that it peirces the aluminium Max torque: 30Nm</p> <p>(S) Bulten skuvas HELT genom aluminiumen. Maks vridmoment: 30Nm</p>				
NO	Betongkvalitet			
SE	Betongkvalitet			
EN	Concrete quality			
NO	Mengde betong			
SE	Mängd betong		2,4 m <sup>3</sup>	
EN	Amount of concrete			
NO	Fundament størrelse			
SE	Stiftelsestorlek			
EN	Foundation size			
NO	For sikkerhet må fundamentene med sand eller myk jord være minst 50% større i areal			
SE	För säkerheten måste grunden med sand eller mjuk jord vara minst 50% större i området			
EN	For safety, the foundations with sand or soft soil must be at least 50% larger in area			
NO	Tyngste element			
SE	Tyngsta element	SFA5117/1	10,5	Kg
EN	Heaviest element			
NO	Største element			
SE	Största element	SFA5117/1 06-200-526	3,230x0,95x0,95 2x1,2x0,3	m
EN	Biggest element			

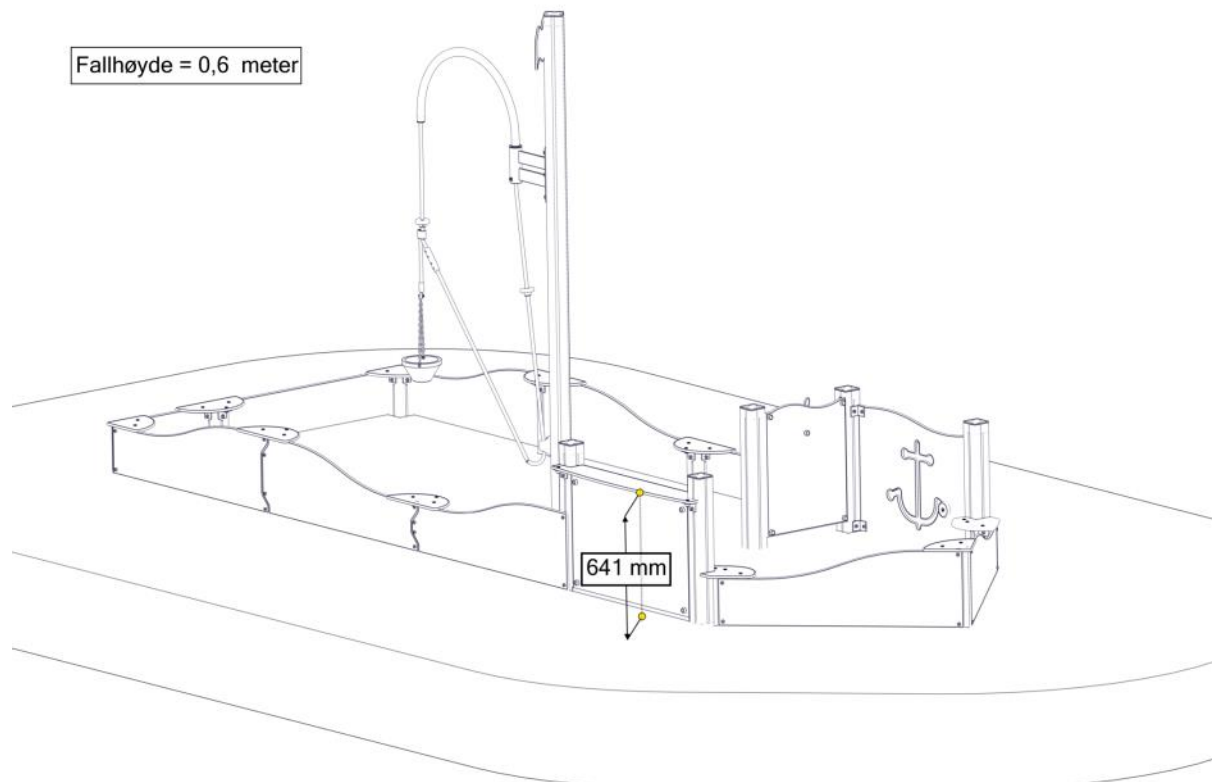
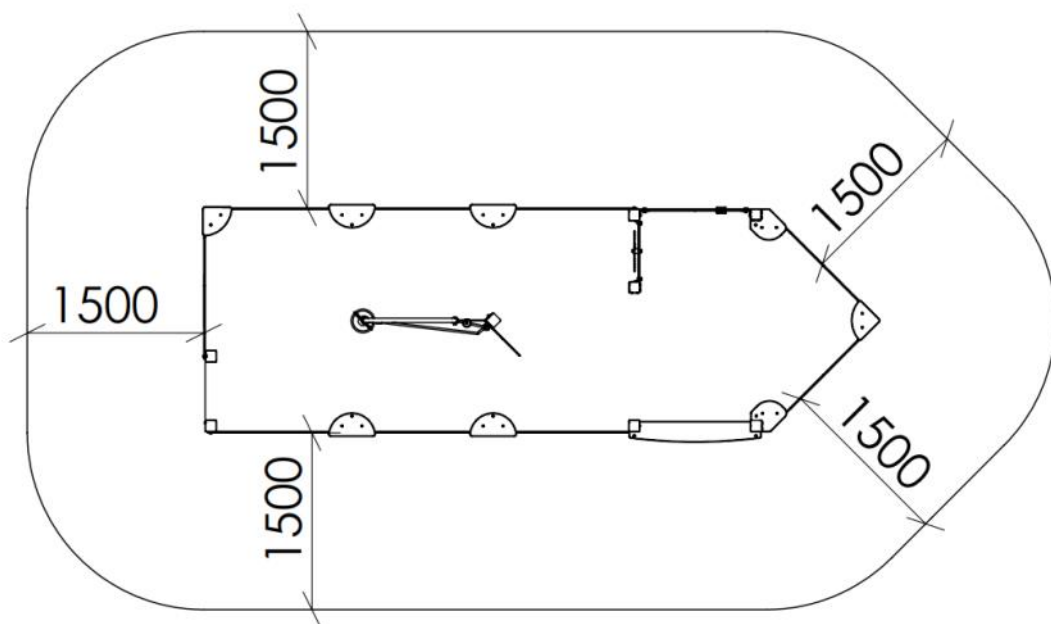
**Fallhøyder / Free height of fall / Fallhöjder****Sikkerhetszone / Safety zone / Säkerhetszon**

Plassering av forankringer / Ground plan / Placering av förankringar

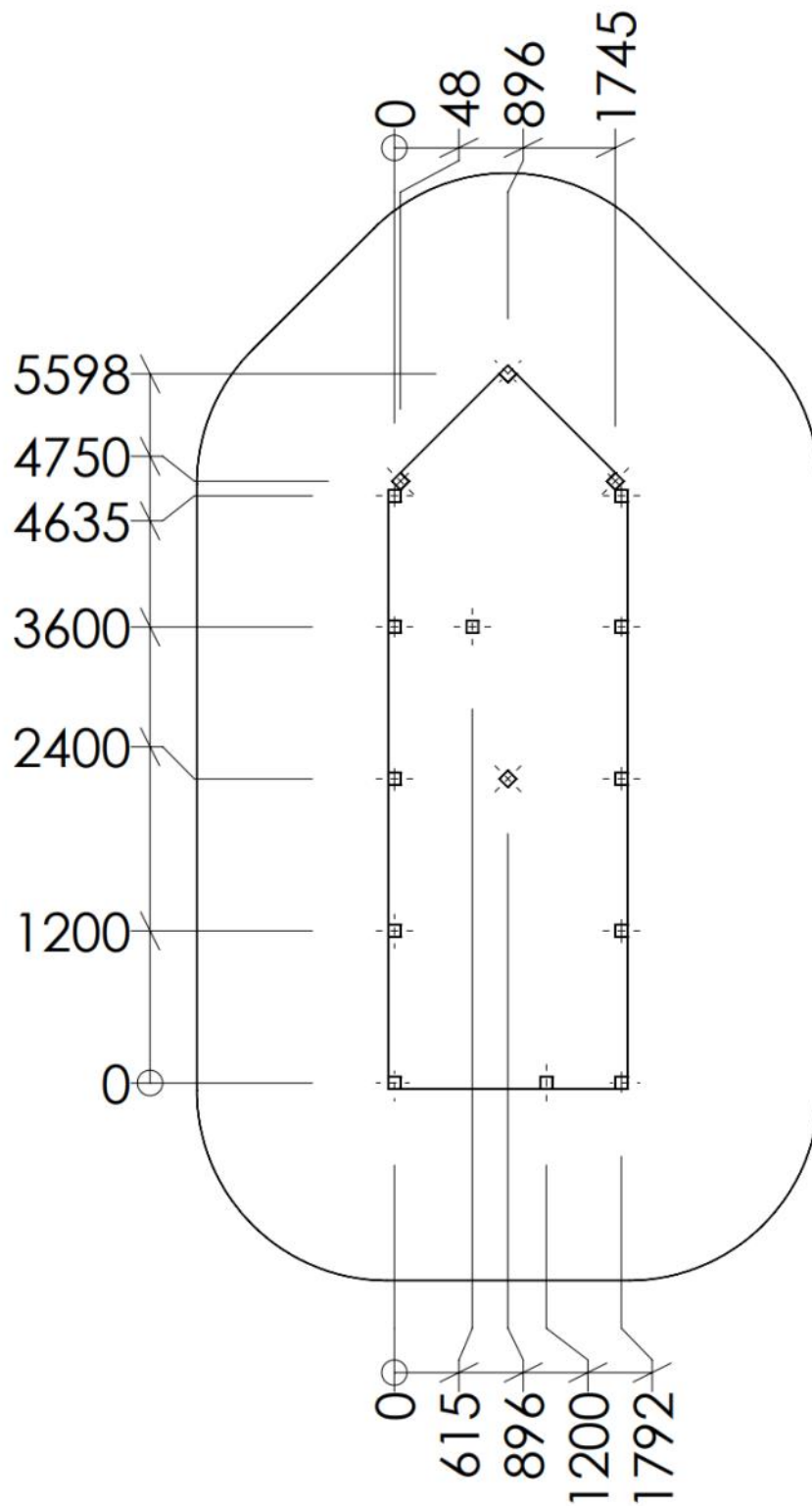

N

Alle mål er oppgitt i millimeter

EN

Scale measured in mm

S

Alla mått är i millimeter.

# Montering av lekeapparatet / Assembly instructions / Montering av lekredskapet

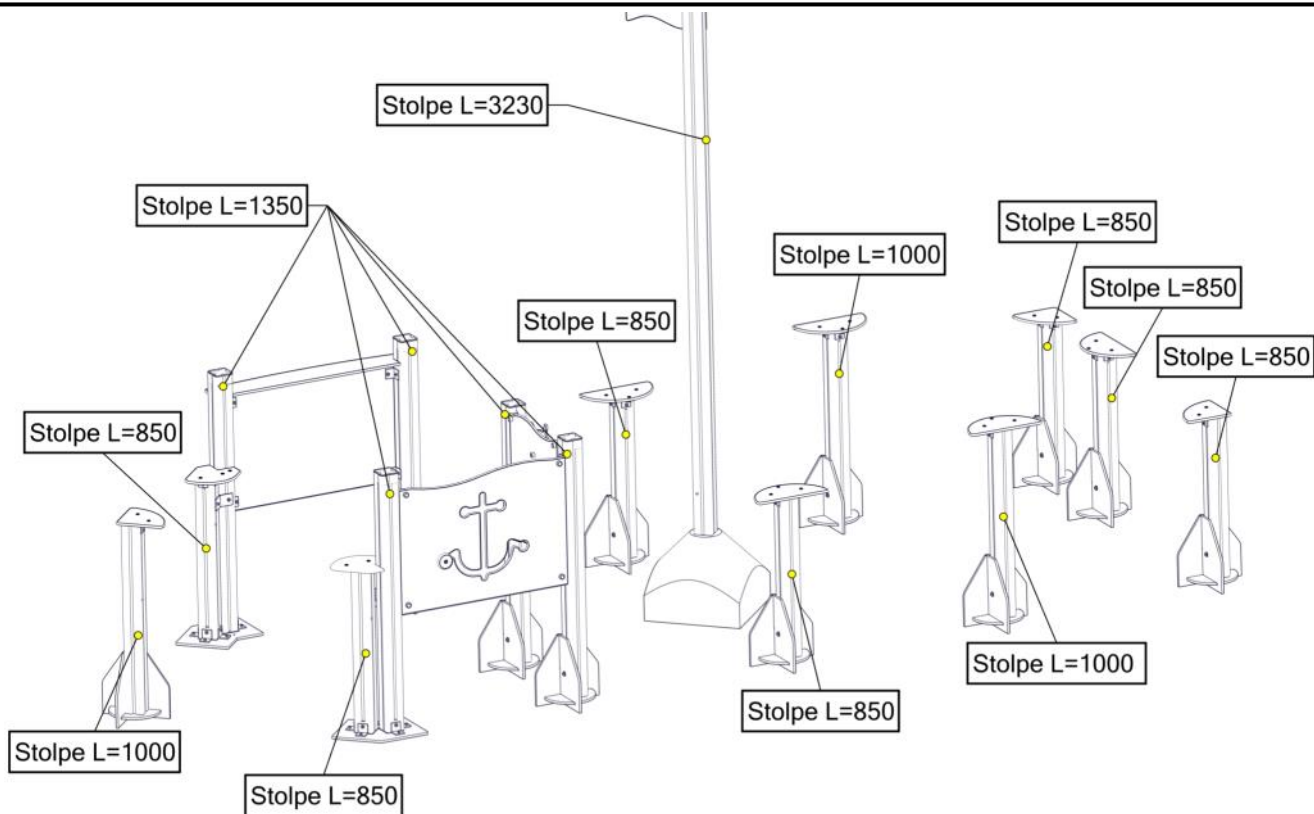

## Montering av lekeapparatet / Assembly instructions / Montering av lekredskapet

Se separat delmontering for detaljer  
 See separate assembly for details  
 Se separata delmontering för detaljer

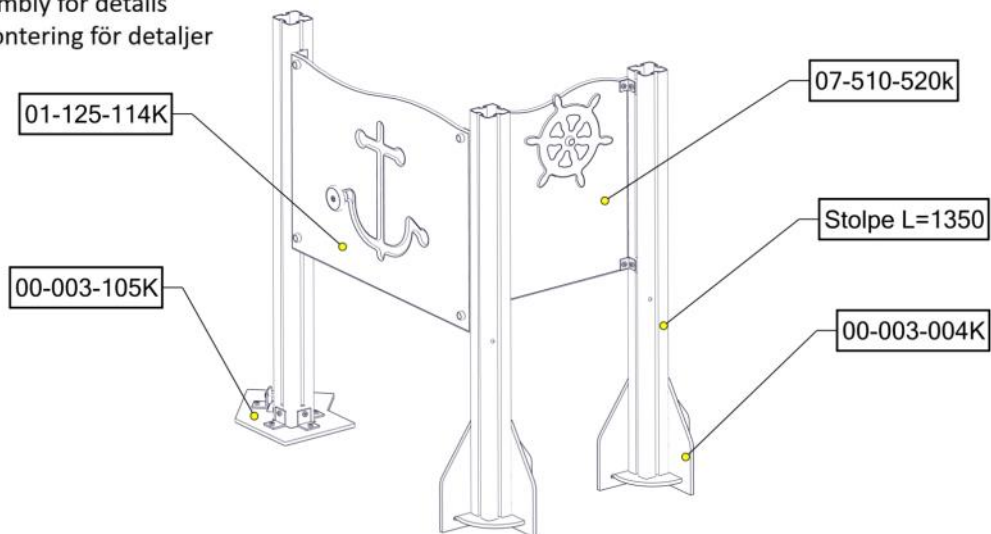

PartName	Artnr	Antall
Fundament-2x95_135gr	00-003-105K	1
Mini-vegg 520x600 med ratt treverk	07-510-520k	1
Nedgravingsfundament 95x95	00-003-004K	2
Rekkverk 940x665x12 /m spill	01-125-114K	1
Stolpe 95 L=600-750	SFA5117/2	3

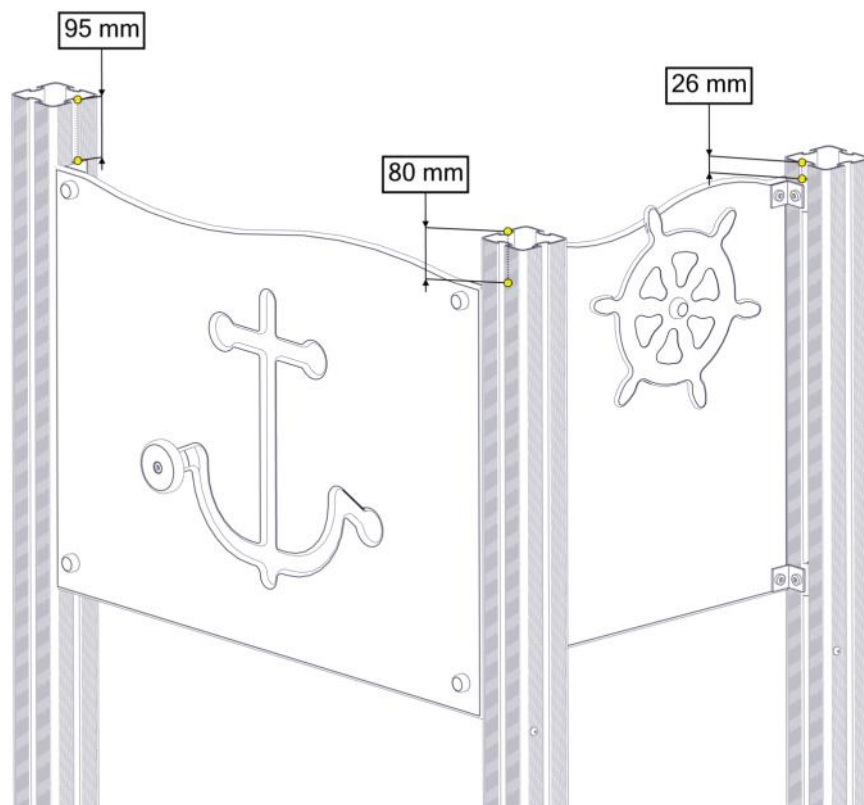



## Montering av lekeapparatet / Assembly instructions / Montering av lekredskapet

Se separat delmontering for detaljer  
 See separate assembly for details  
 Se separata delmontering för detaljer

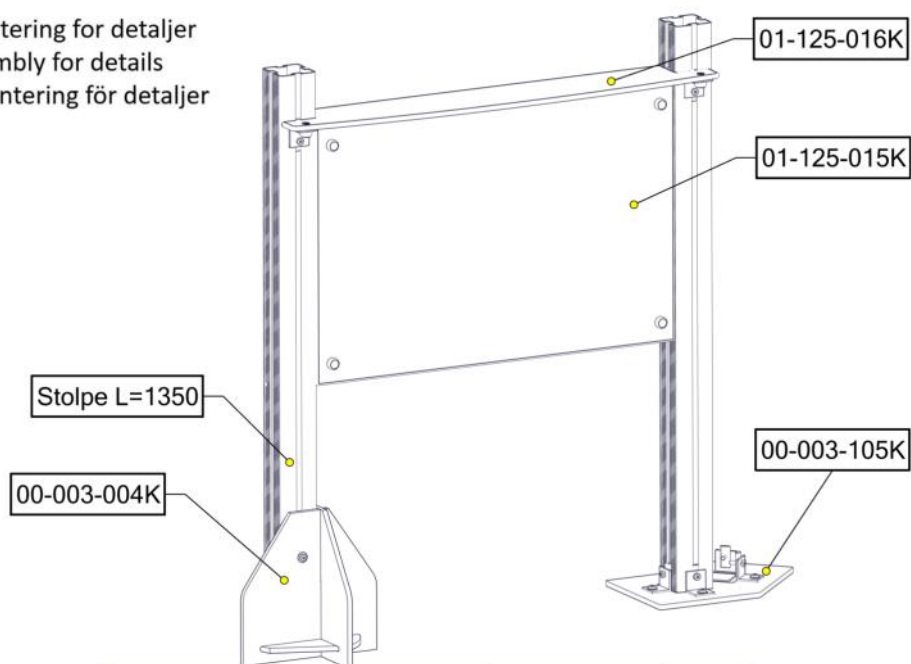

PartName	Artnr	Antall
Butikkdisk 1122 x 175 x 12	01-125-016K	1
Fundament-2x95_135gr	00-003-105K	1
Nedgravingsfundament 95x95	00-003-004K	1
Rekkverk butikkdisk 940x630x12	01-125-015K	1
Stolpe 95 L=600-750	SFA5117/2	2

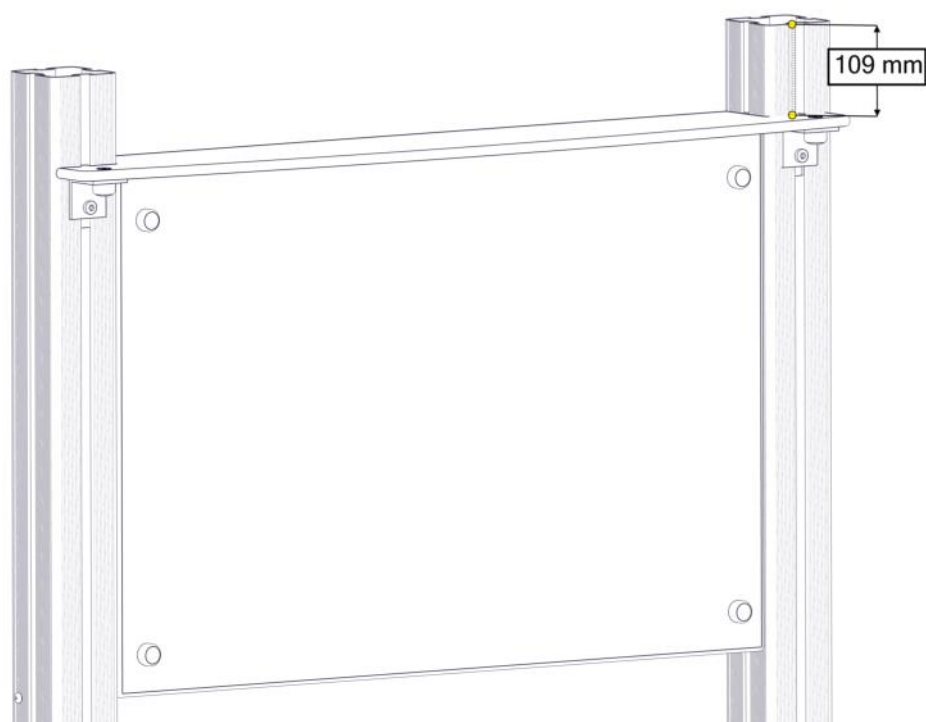

## Montering av lekeapparatet / Assembly instructions / Montering av lekredskapet

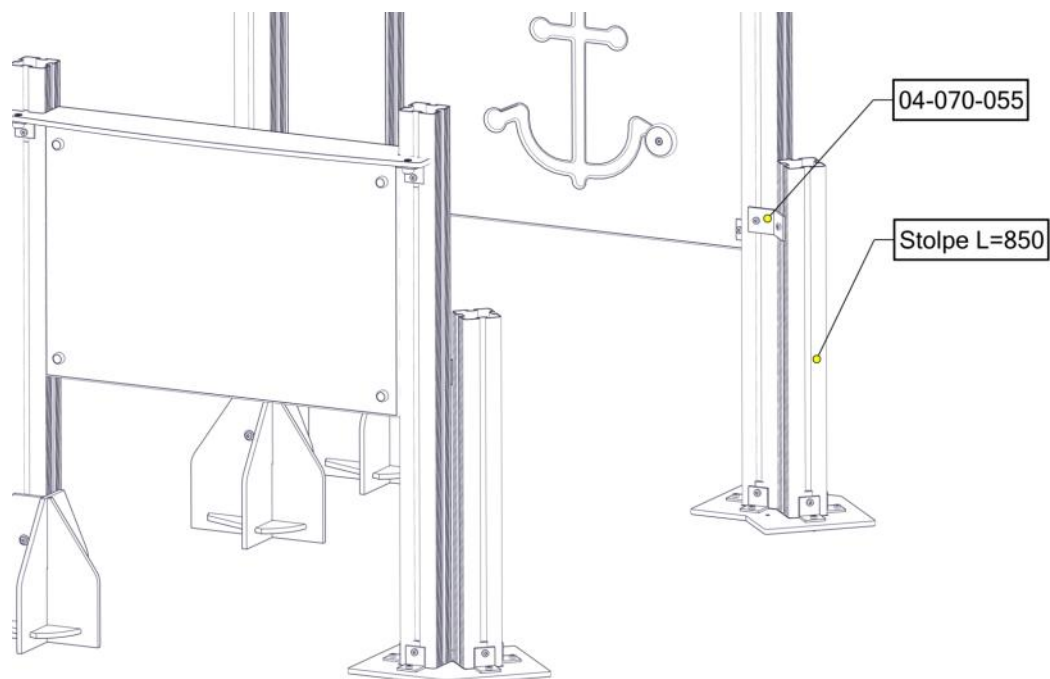

PartName	Artnr	Antall
Brikke 50 1XM8	04-060-050	4
Stolpe 95x95 L=850	SFA5117/1	2
Torx M8x25	04-000-025	4

PartName	Artnr	Antall
Vinkel 70x70 135gr	04-070-055	2

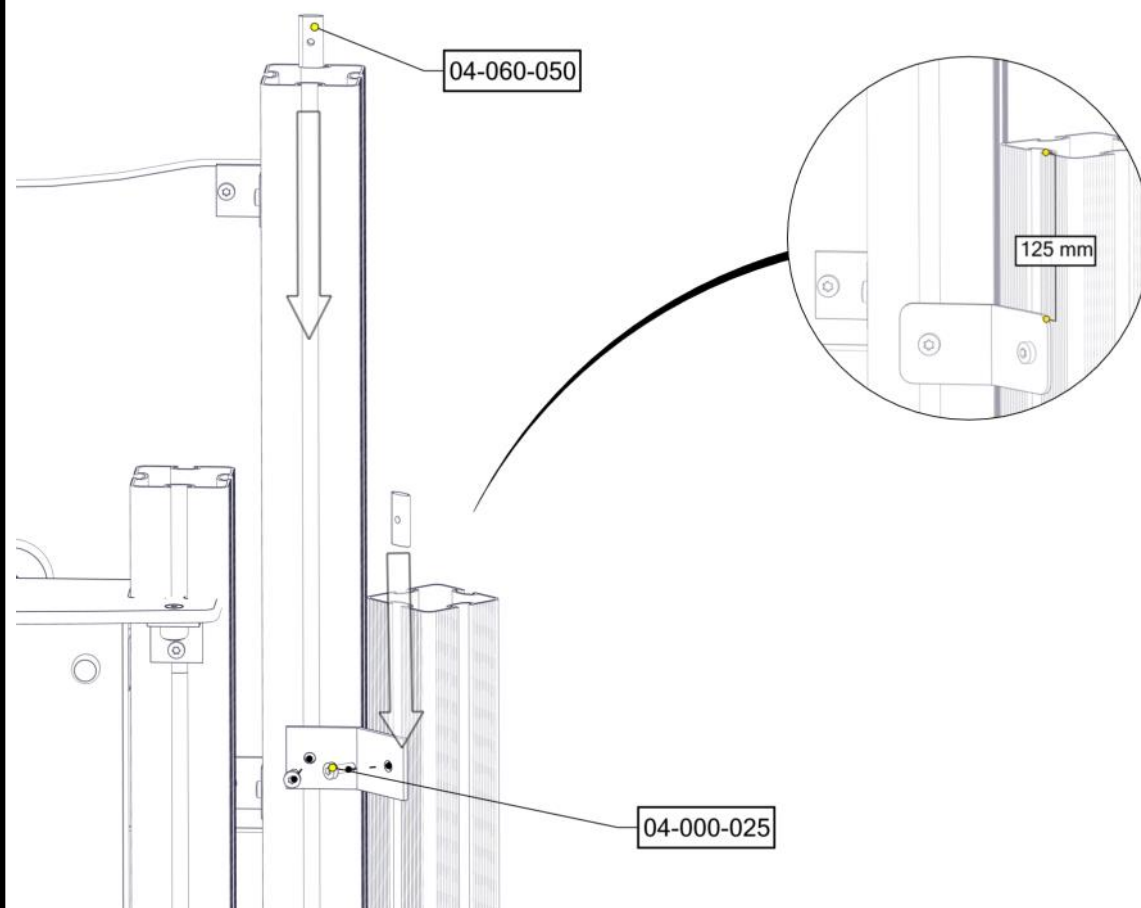

## Montering av lekeapparatet / Assembly instructions / Montering av lekredskapet

Se separat delmontering for detaljer  
 See separate assembly for details  
 Se separata delmontering för detaljer

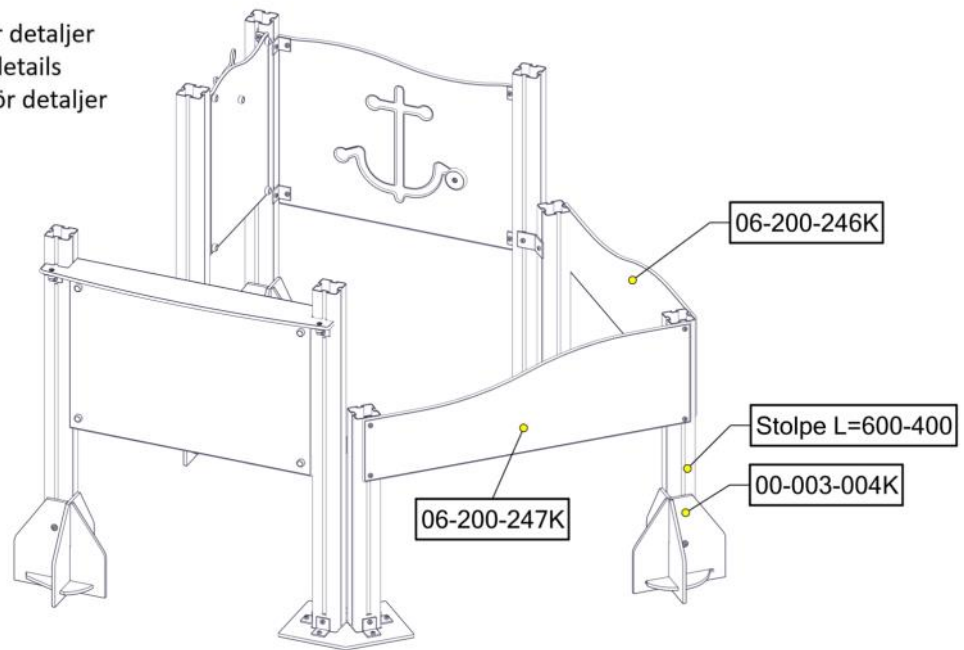

PartName	Artnr	Antall
Nedgravingsfundament 95x95	00-003-004K	1
Stolpe 95 L=600-400	SFA5117/2	1
Vegg 400Rett 250Rett	06-200-246K	1
Vegg 400Rett 250Rett	06-200-247K	1

Se separat delmontering for detaljer  
 See separate assembly for details  
 Se separata delmontering för detaljer

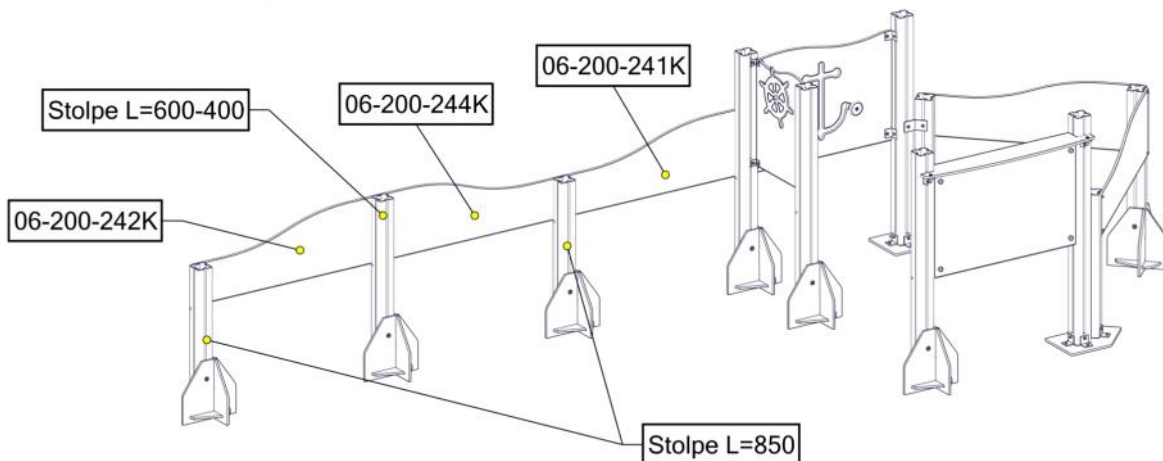

PartName	Artnr	Antall
Nedgravingsfundament 95x95	00-003-004K	3
Stolpe 95 L=600-400	SFA5117/2	1
Stolpe 95x95 L=850	SFA5117/1	2
Vegg 250Male 400Female	06-200-244K	1

PartName	Artnr	Antall
Vegg 400Male 250Rett	06-200-242K	1
Vegg 400Rett 250 Female	06-200-241K	1

## Montering av lekeapparatet / Assembly instructions / Montering av lekredskapet

Se separat delmontering for detaljer  
 See separate assembly for details  
 Se separata delmontering för detaljer

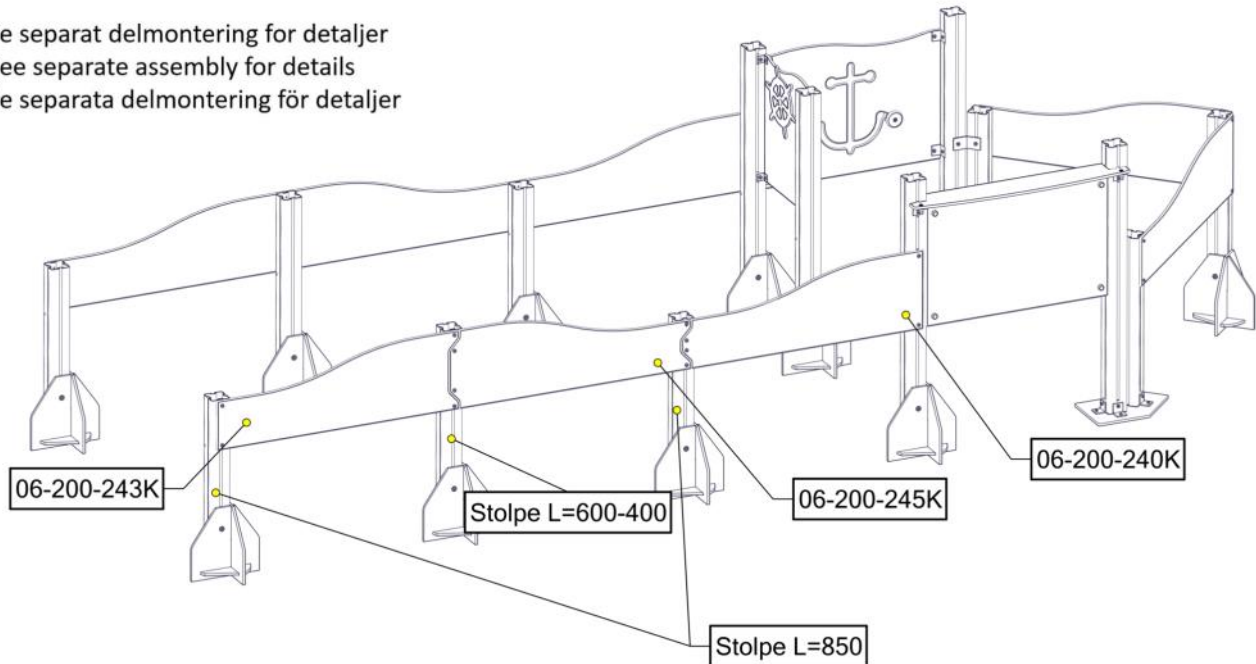

PartName	Artnr	Antall
Nedgravingsfundament 95x95	00-003-004K	3
Stolpe 95 L=600-400	SFA5117/2	1
Stolpe 95x95 L=850	SFA5117/1	2
Vegg 250Male 400Rett	06-200-240K	1

PartName	Artnr	Antall
Vegg 250Rett 400Female	06-200-243K	1
Vegg 400Male 250Female	06-200-245K	1

Se separat delmontering for detaljer  
 See separate assembly for details  
 Se separata delmontering för detaljer

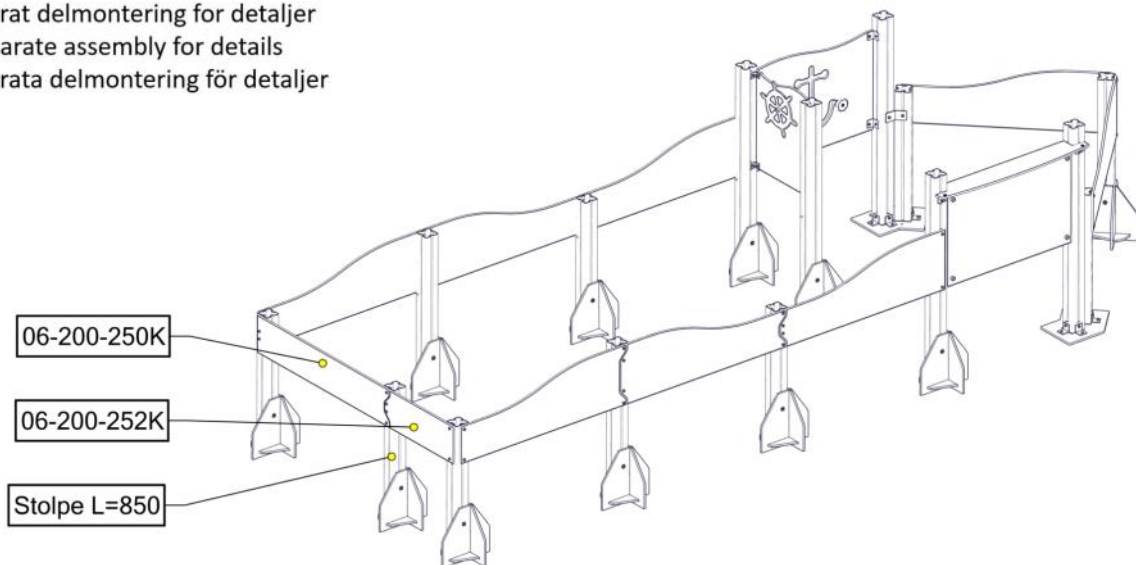

PartName	Artnr	Antall
Nedgravingsfundament 95x95	00-003-004K	1
Stolpe 95x95 L=850	SFA5117/1	1
Vegg 250 Male-Female-kort	06-200-252K	1
Vegg 250 Rett-Female	06-200-250K	1

## Montering av lekeapparatet / Assembly instructions / Montering av lekredskapet

Se separat delmontering for detaljer  
 See separate assembly for details  
 Se separata delmontering för detaljer

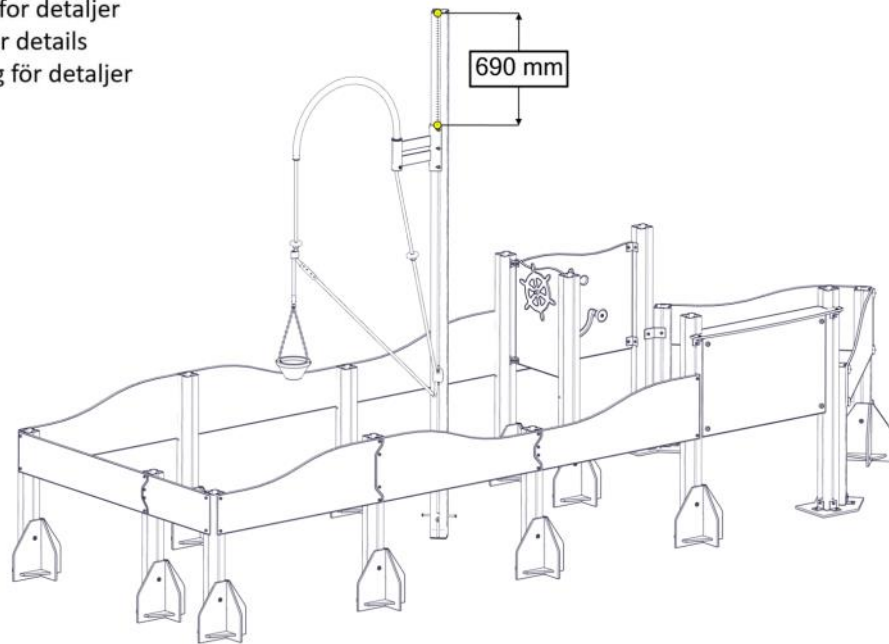

PartName	Artnr	Antall
Fundament til støp 95x95 stolpe	00-003-110K	1
Sandkran sving Med tau og ropeguide	06-200-526K	1
Stolpe 95x95 L=3230	SFA5117/1	1

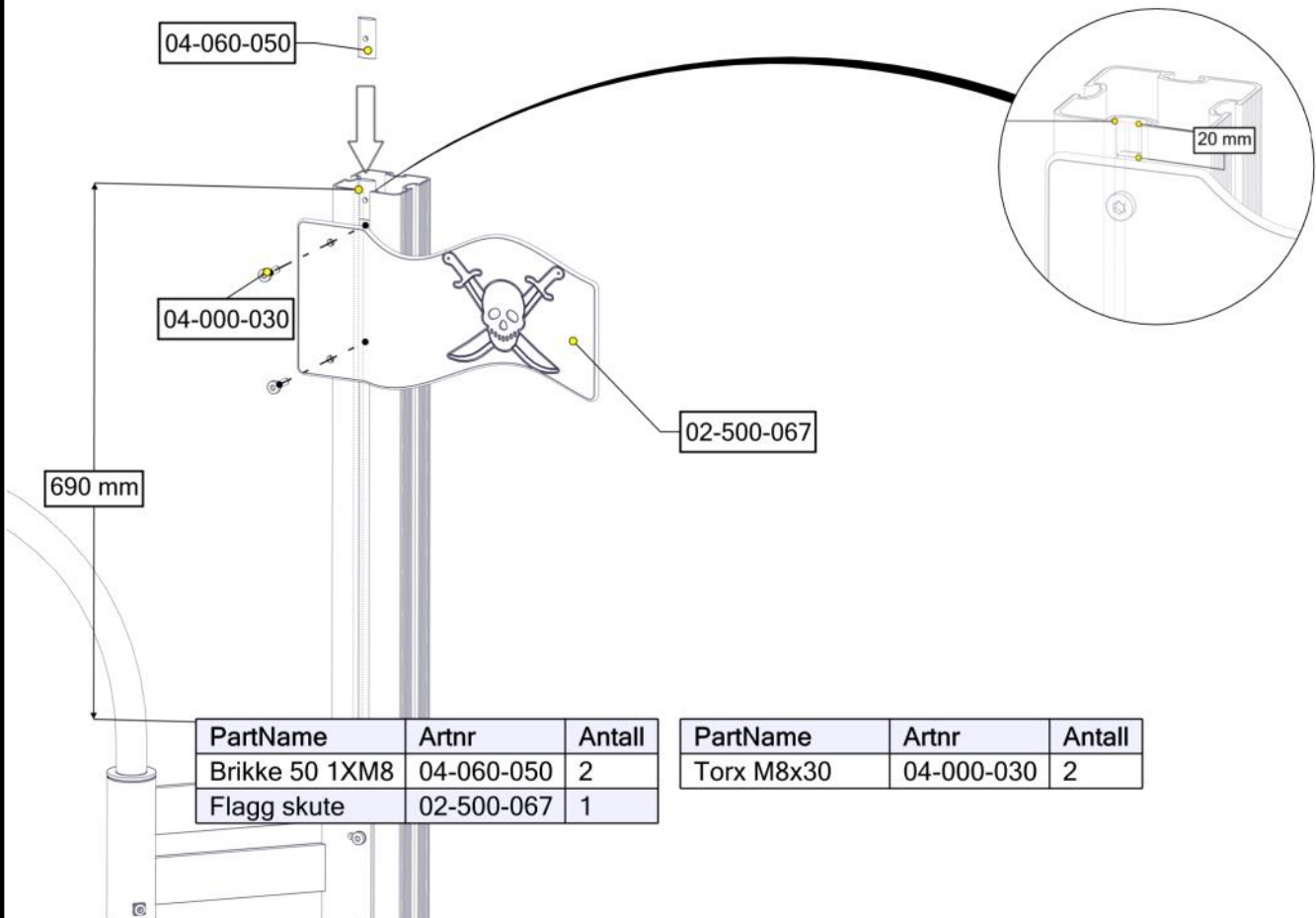

PartName	Artnr	Antall
Brikke 50 1XM8	04-060-050	2
Flagg skute	02-500-067	1

PartName	Artnr	Antall
Torx M8x30	04-000-030	2

## Montering av lekeapparatet / Assembly instructions / Montering av lekredskapet

Se separat delmontering for detaljer  
 See separate assembly for details  
 Se separata delmontering för detaljer

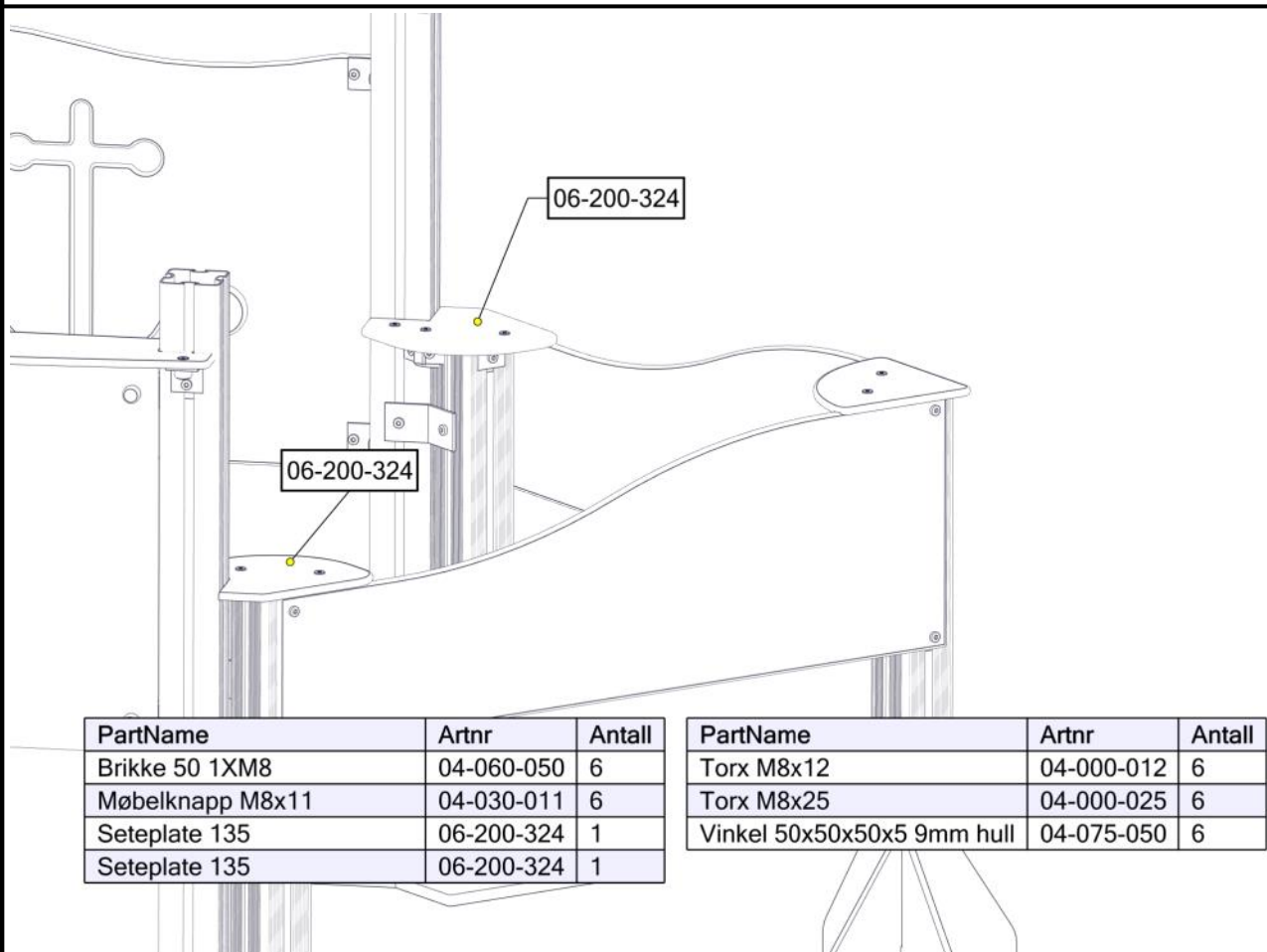
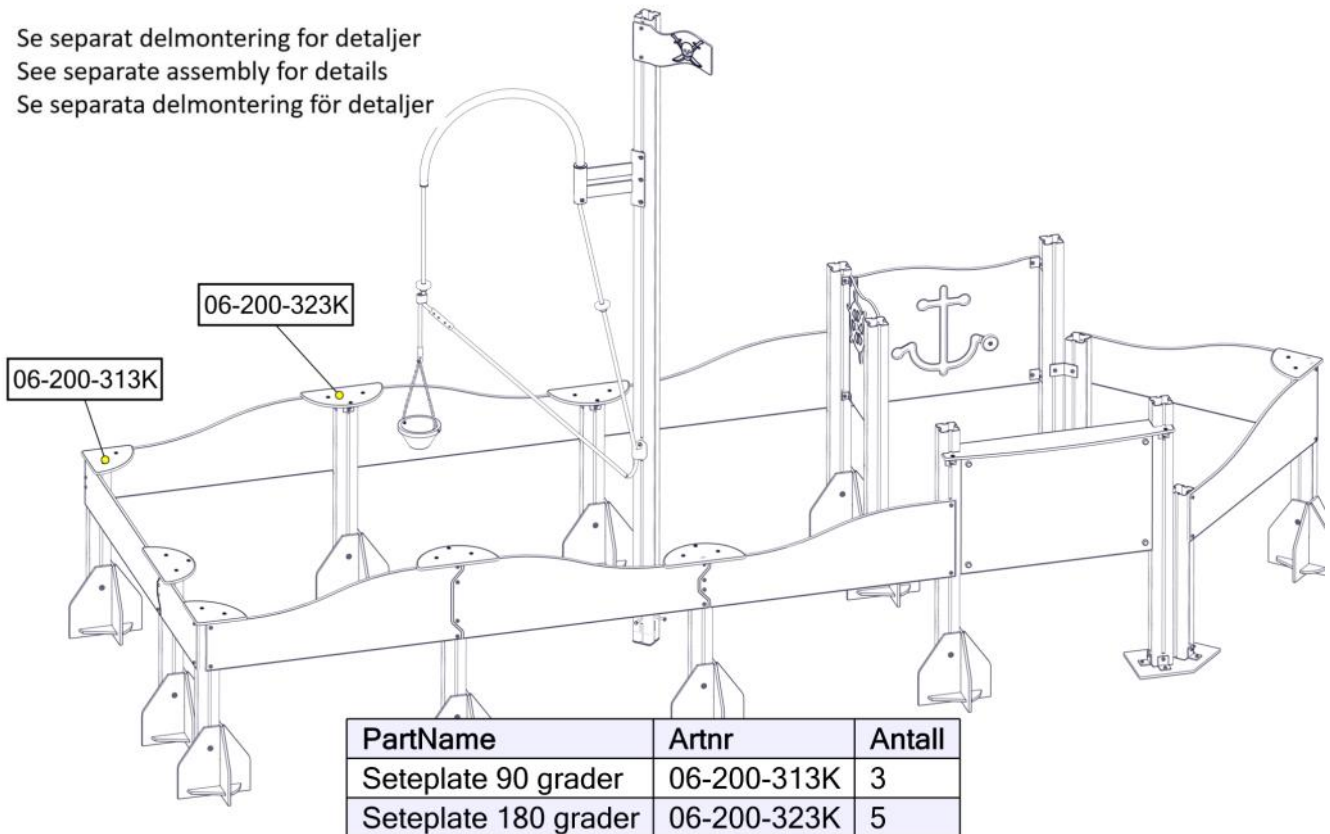

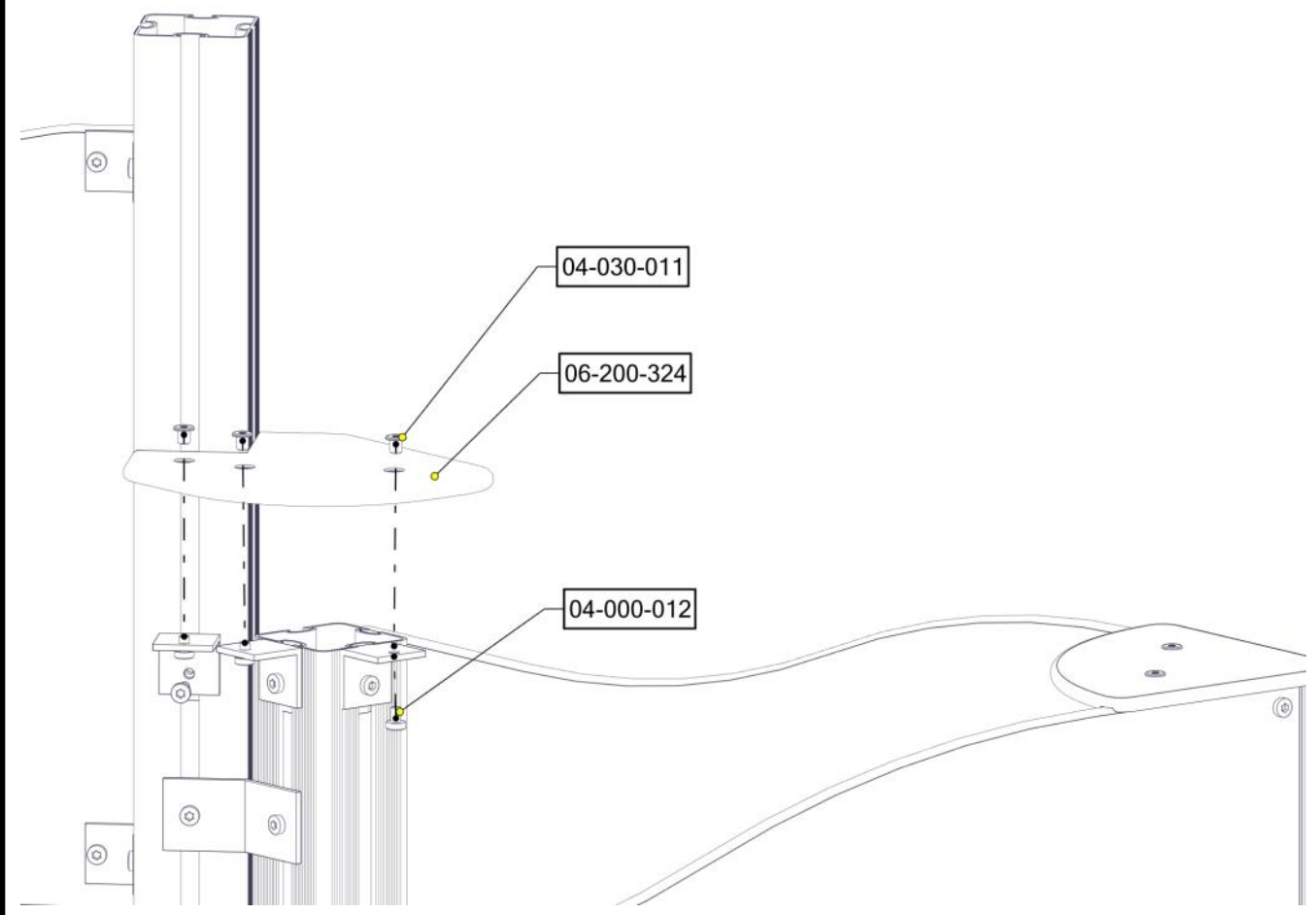
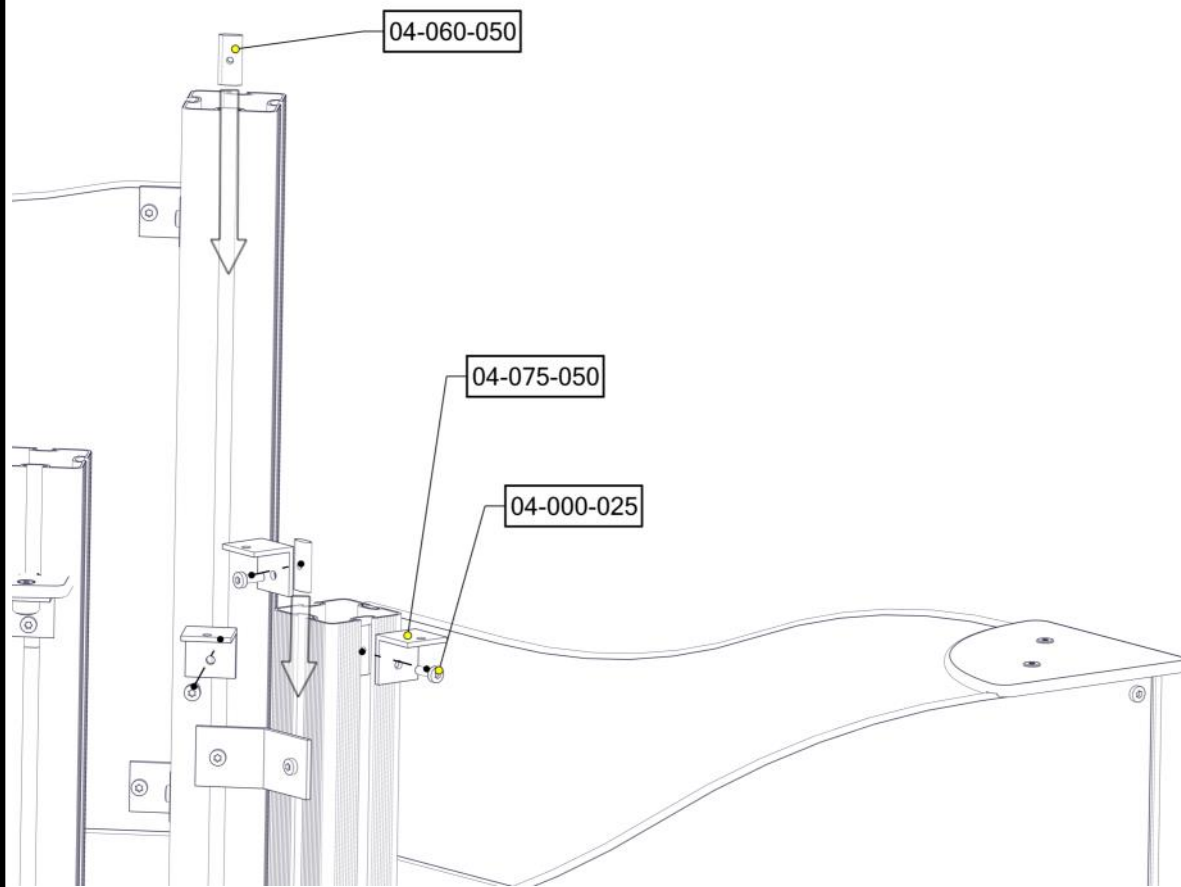
**Montering av lekeapparatet / Assembly instructions / Montering av lekredskapet**

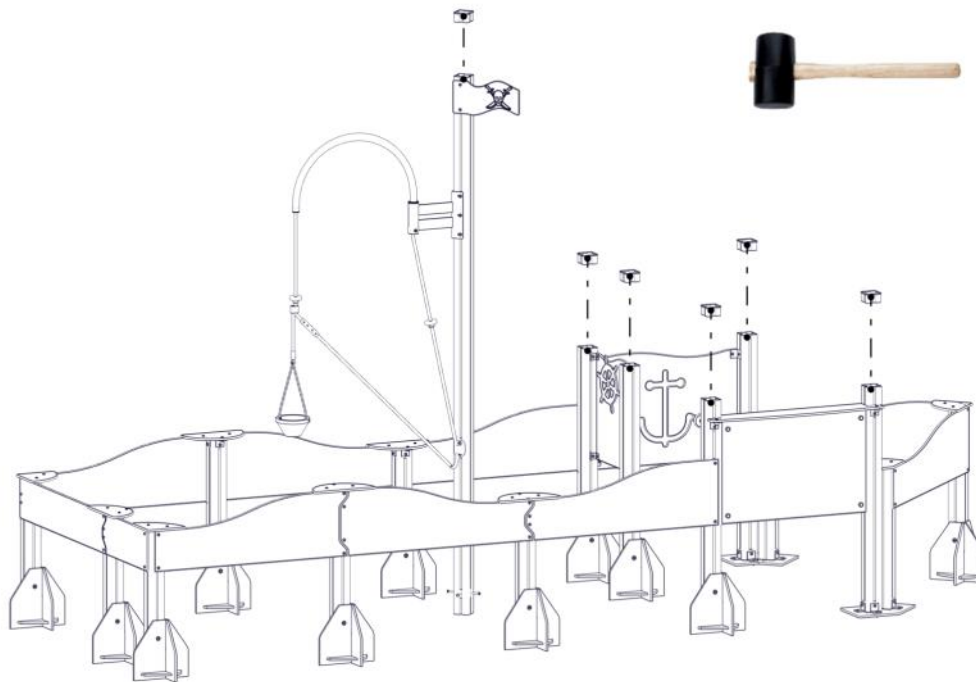
**Montering av lekeapparatet / Assembly instructions / Montering av lekredskapet**



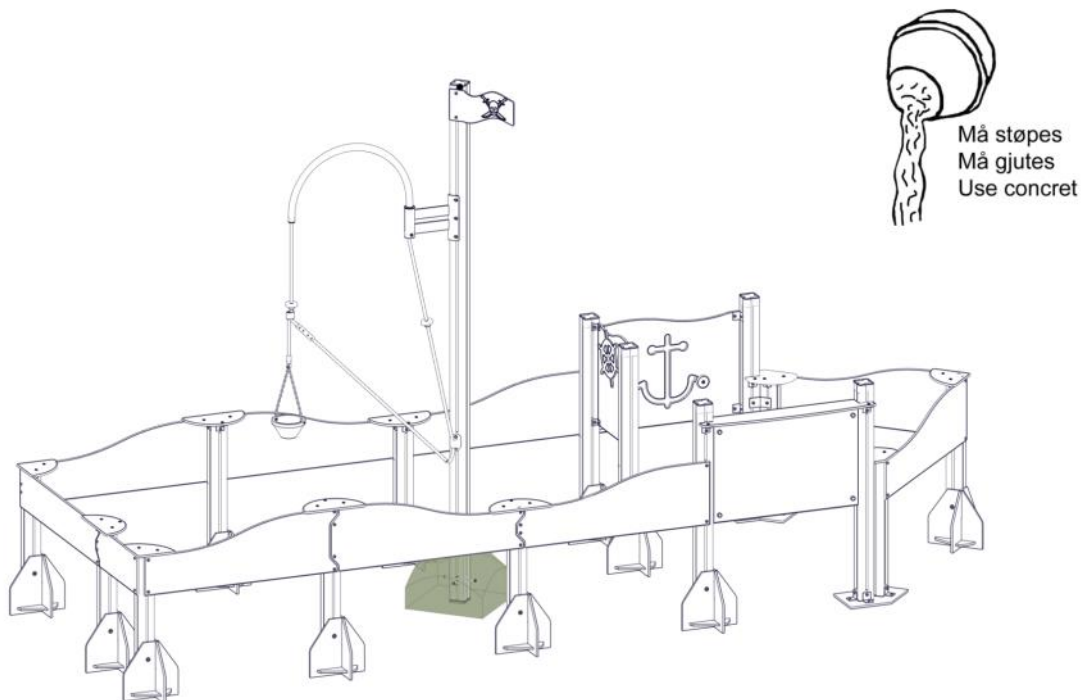

PartName	Artnr	Antall
Endelokk 95x95	00-400-998	6





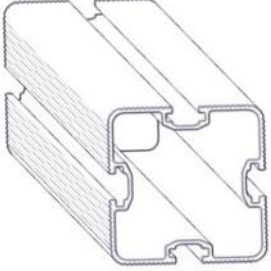
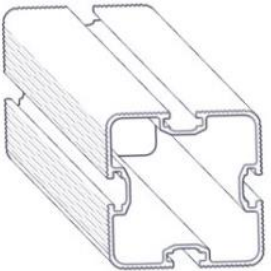

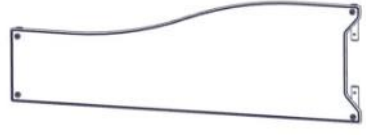



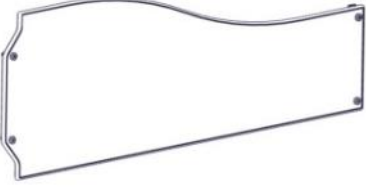



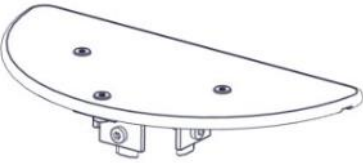
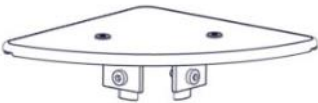

<b>Før utstyret tas i bruk / Before play begins / Innan lekredskapet tas i bruk</b>	
<b>N</b>	<ul style="list-style-type: none"> <li>● Påse at fallunderlag er utlagt i henhold til gjeldende regler eller vår anbefaling</li> <li>● Fjern alle monteringshjelpemidler ( rester av betong, planker, paller, plast, og lignende)</li> <li>● Før utstyret tas i bruk, burde man sjekke at det ikke er fare for at anorakksnorer og lignende som kan hekte seg fast noen steder på lekeapparatet. (Vedlagte snor med dobbe (kneledd) kan brukes til å sjekke at dette er i orden. Se vedlagte veiledning for bruk av denne. Dette gjøres for å oppdage eventuelle feilmonteringer.?)</li> <li>● NB! Bør stå i 2-3 dager før bruk</li> </ul>
<b>EN</b>	<ul style="list-style-type: none"> <li>● Make sure the area and depth of safer surfacing are according to the current standard, or to the manufacturer's recommendation</li> <li>● Make sure all tools and surplus materials are removed before play begins</li> <li>● PS! When complete, allow 2-3 days for the concrete to set before use</li> </ul>
<b>S</b>	<ul style="list-style-type: none"> <li>● Kontrollera att fallunderlag är utlagt enligt gällande regler eller vårt rekommendation</li> <li>● Ta bort alla monteringshjälpmedel (rester av betong, plankor, pallar, plast och liknande)</li> <li>● Innan lekredskapet används, kontrollera att anoracksnoddar eller kläder/delar av kläder eller liknande inte kan fastna i några delar på redskapet. (Den bipackade "knävringen" kan man med fördel användas för denna kontroll.</li> <li>● Detta görs för att upptäcka eventuella felmonteringar.)</li> </ul>

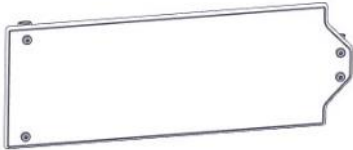
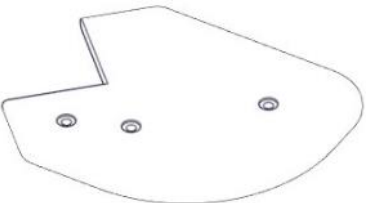
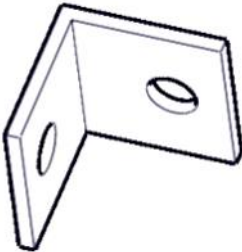



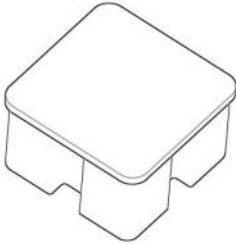
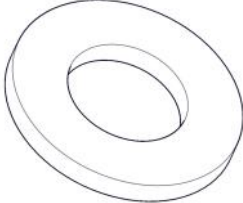
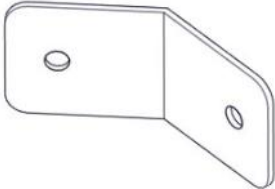



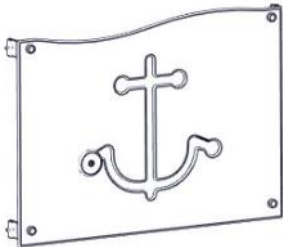

<b>Boltepakker for / Boltpackage for / Bultpaket för</b>		Sign. _____		
<b>Sandkasse båt, 61-200-700 Trestruktur</b>	<b>Navn</b>	<b>Artnr/ dimensjon</b>	<b>Ant</b>	<b>Lev</b>
	Stolpe 95 x 95 600-400 L= 1000 Sort	SFA5117/1	3	
	Stolpe 95 x 95 600-750 L= 1350 Sort	SFA5117/1	5	
	Stolpe 95 x 95 600-250 L= 850 Sort	SFA5117/1	7	
	Stolpe 95 x 95 600-2630 L= 3230 Sort	SFA5117/1	1	
	Vegg 250 male/ 400 rett 1250 x 250/400 Trestruktur	06-200-240K (se egen delmontering)	1	
	Vegg 250 rett/ 400 female 1250 x 250/400 Trestruktur	06-200-243K (se egen delmontering)	1	
	Vegg 250 male/ 400 female 1250 x 250/400 Trestruktur	06-200-244K (se egen delmontering)	1	
	Vegg 400 male/ 250 female 1250 x 250/400 Trestruktur	06-200-245K (se egen delmontering)	1	

<b>Boltepakker for / Boltpackage for / Bultpaket för</b>		Sign. _____		
<b>Sandkasse båt, 61-200-700 Trestruktur</b>	<b>Navn</b>	<b>Artnr/ dimensjon</b>	<b>Ant</b>	<b>Lev</b>
	Vegg 400 male/ 250 rett 1250 x 250/400 Trestruktur	06-200-242K (se egen delmontering)	1	
	Vegg 400 rett/ 250 female 1250 x 250/400 Trestruktur	06-200-241K (se egen delmontering)	1	
	Vegg 400 rett/ 250 rett 1250 x 250/400 Trestruktur	06-200-246K (se egen delmontering)	1	
	Vegg 400 rett/ 250 rett 1250 x 250/400 Trestruktur	06-200-247K (se egen delmontering)	1	
	Seteplate 180 grader Lyse grønn	06-200-323K (se egen delmontering)	5	
	Seteplate 90 grader Lyse grønn	06-200-313K (se egen delmontering)	3	

<b>Boltepakker for / Boltpackage for / Bultpaket för</b>		Sign. _____		
<b>Sandkasse båt, 61-200-700 Trestruktur</b>	<b>Navn</b>	<b>Artnr/ dimensjon</b>	<b>Ant</b>	<b>Lev</b>
	Sandkasse element 250 R Female L=1250 Trestruktur	06-200-250K (se egen delmontering)	1	
	Sandkasse element 250 R female L=660 Trestruktur	06-200-252K (se egen delmontering)	1	
	Seteplate 135 grader Lyse grønn	06-200-324	2	
	Vinkel alu 50x50x5 med 9mm hull	04-075-050	6	
	Produktmerke	00-100-400 (montert hos Søve)	0	

<b>Boltepakker for / Boltpackage for / Bultpaket för</b>		Sign. _____.		
<b>Sandkasse båt, 61-200-700 Trestruktur</b>	<b>Navn</b>	<b>Artnr/ dimensjon</b>	<b>Ant</b>	<b>Lev</b>
	Endelokk 95x95	00-400-998	6	
	Skive M8	04-050-008	6	
	Vinkel 135 grader	04-070-055	2	
	Torx M8x12 Torx M8x25 Torx M8x35	04-000-012 04-000-025 04-000-035	6 10 2	
	Brikke 50x8x23 1hull	04-060-050	12	
	Møbelknapp M8x11	04-030-011	6	

<b>Boltepakker for / Boltpackage for / Bultpaket för</b>		Sign. _____		
<b>Sandkasse båt, 61-200-700 Trestruktur</b>	<b>Navn</b>	<b>Artnr/ dimensjon</b>	<b>Ant</b>	<b>Lev</b>
	Butikdisk 1122x175 Grå	01-125-016K (se egen delmontering)	1	
	Minivegg 520x600 med ratt Trestruktur	07-510-520K (se egen delmontering)	1	
	Rekkverk 940x665x12 med spill Marine Trestruktur	01-125-114K (se egen delmontering)	1	
	Rekkverk butikdisk 940x630x12 Trestruktur	01-125-015K (se egen delmontering)	1	
	Sandkran sving med tau og ropeguide	06-200-526K (se egen delmontering)	1	
	Flagg skute	02-500-067	1	

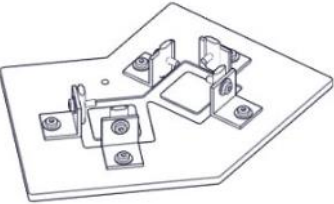
<b>Boltepakker for / Boltpackage for / Bultpaket för</b>		Sign. _____		
<b>Sandkasse båt, 61-200-700 Trestruktur</b>	<b>Navn</b>	<b>Artnr/ dimensjon</b>	<b>Ant</b>	<b>Lev</b>
	<b>Fundament Støp</b>			
	00-003-110K	00-003-110K	16	
	<b>Fundament Nedgravning</b>			
	00-003-110K	00-003-110K	1	
	Nedgravningsfundament 95 x 95 stolpe	00-003-004K (se egen delmontering)	11	
	Fundament til 2stk 95 stolpe	00-003-105K (se egen delmontering)	2	



21.02.2025 MNO

Feil antall av hjørneseter korrigeret fra 1stk til 2 stk