

N**Monteringsanvisning****EN****Assembly Instructions****S****Monteringsanvisning**

Produkt nr. / Product no. / Produkt nr.

07-500-500

Ord. nr. _____

Dato. _____

Sign. _____

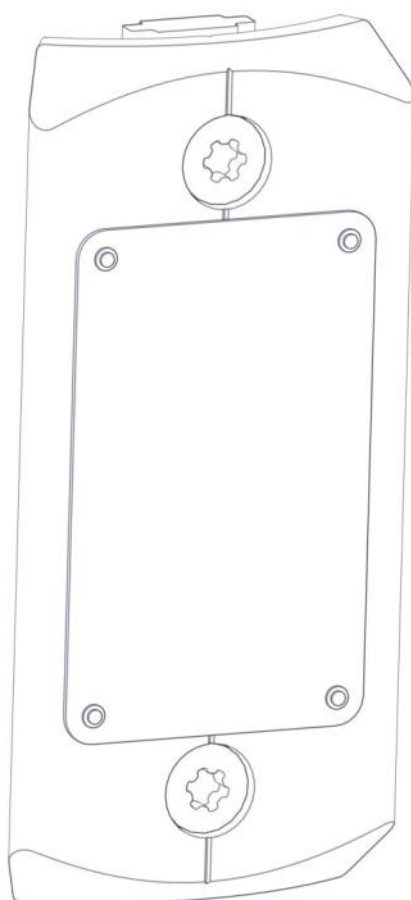
**søve**



Søve AS
Grønnvoldveien 290
3830 Ulefoss - Norway
Tlf: +47 35 94 65 65
www.sove.no

**søve**

Søve AB
EA Rosengrensgatan 32
421 31 Västra Frölunda
Phone: +46 (0)31 773 97 00
www.sove.se

Boltepakker for / Boltpackage for / Bultpaket för

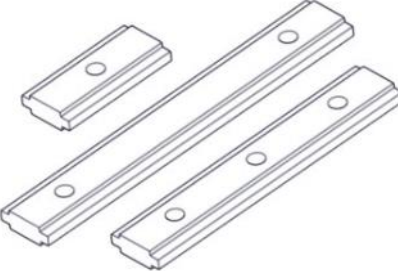
Sign. _____.

Produktmerke Ø110 stolpe 07-500-500	Navn	Artnr/dimensjon	Ant	Lev
	Beslag 0gr L=150 2 hull Inkl. merkeskilt	00-100-403	1	
	Brikke 150 2xM8	04-060-151	1	
	Torx M8x25	04-000-025	2	

Montering av lekeapparatet / Assembly instructions / Montering av lekredskapet

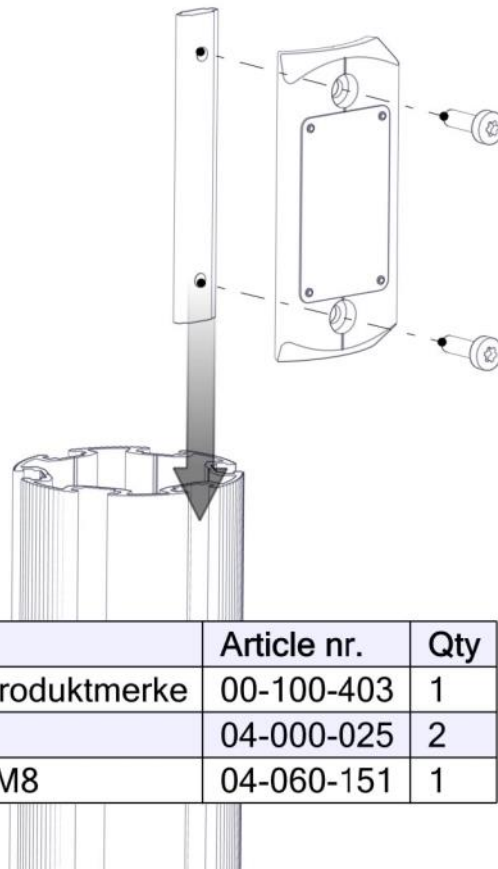

Se på hovedmontering for posisjon
Look at main assembly for position
Titta på hovudmontering for position



Part Name	Article nr.	Qty
Beslag med Produktmerke	00-100-403	1
Torx M8x25	04-000-025	2
Brikke 150 2xM8	04-060-151	1

Boltepakker for / Boltpackage for / Bultpaket för

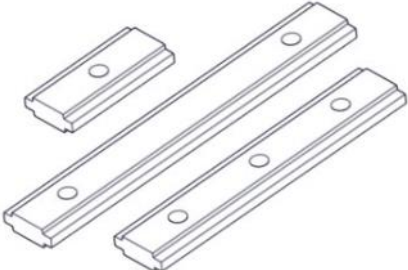
Sign. _____.

Produktmerke Ø110 stolpe 07-500-500	Navn	Artnr/dimensjon	Ant	Lev
	Beslag 0gr L=150 2 hull Inkl. merkeskilt	00-100-403	1	
	Brikke 150 2xM8	04-060-151	1	
	Torx M8x25	04-000-025	2	

MTK: 10-12-2021

Endret artiklenummer av beslag inkl poppet merking