



Monteringsanvisning



Assembly Instructions



Monteringsanvisning

Produkt nr. / Product no. / Produkt nr.

52-200-030

Rød

Ord. nr. _____

Dato. _____

Sign. _____

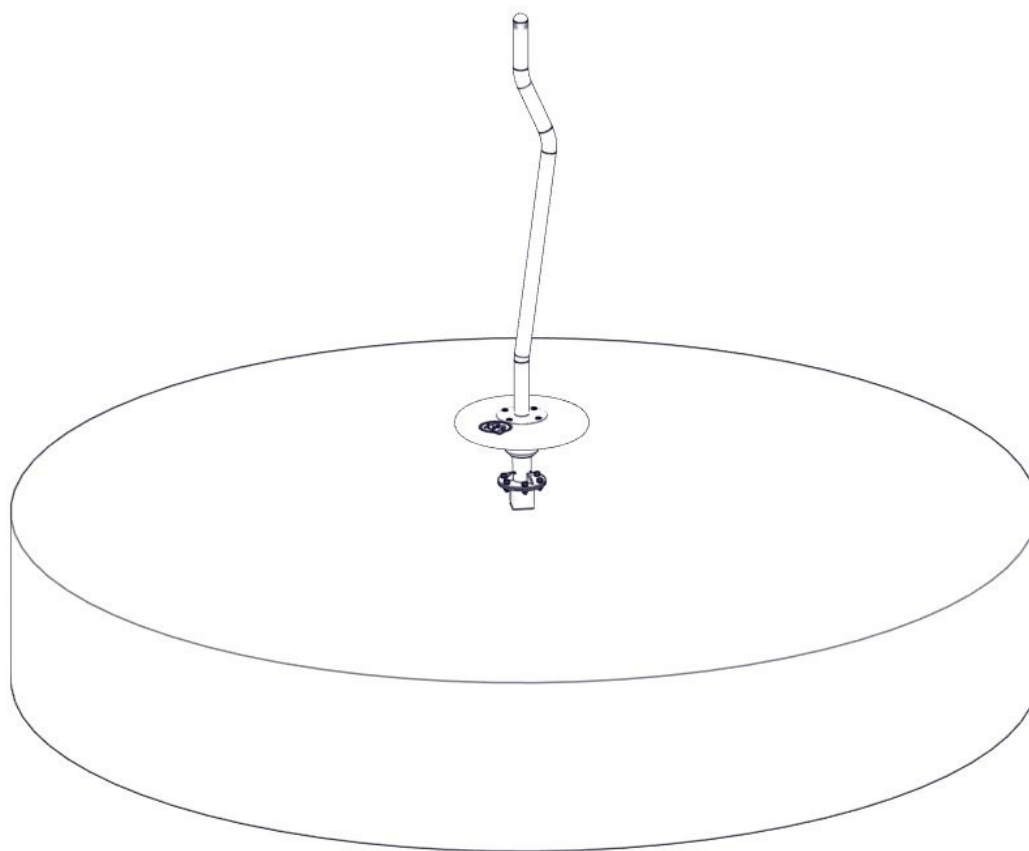

søve

Søve AS
Grønnvoldveien 290
3830 Ulefoss - Norway
Tlf: +47 35 94 65 65
www.sove.no



søve

Søve AB
EA Rosengrensgatan 32
421 31 Västra Frölunda
Phone: +46 (0)31 773 97 00
www.sove.se

Monteringstips / Assembly Advice / Monteringsstips

N

- Les monteringsanvisningen nøye før montering.
- Monter elementene i rekkefølgen som vist.
- Boltene bør ikke skrues for hardt til før alt er montert, vatret og loddet. Skru så boltene til.
- NB! Ved bruk av drill, kan boltene ryke.
- Er lekeutstyret plassert i naturlige ferdselstraséer må området sikres mot gjennomgang.
- Innspringningshinder bør vurderes rundt lekeapparater hvor det er stor bevegelse, f.eks. ved huskestativ.
- Det bør være fritt innsyn til lekeutstyr som er beregnet for barn under 3 år.

NB! Under monteringsarbeidet må utstyr, som ikke er forankret forsvarlig i bakken, sikres slik at det ikke velte.

Området må avstenges under montering av apparatene med sperrebånd eller lignende.

EN

- Read the instruction carefully before assembling the play unit..
- Assemble the components in the sequence shown in these instructions.
- Fixings must not be fully tightened during assembly. Before casting the foundations, the structure must be level and plumb, at which point all fixings are tightened.
- PS! If use of drill, the bolts may be wrecked.
- Secure the construction-area to prevent people from walking through it.
- Consider installing barriers around play-equipment which gives rise to a lot of activity – i.e.swings.
- Ensure that clear vision is possible across the play area so that supervision is possible from any position, particularly where children under 3 years of age will be playing.

NB! During assembly of the equipment, ensure that all structures are securely propped, especially when left overnight. Also ensure that equipment is supported whilst concrete foundations are setting and enclose the area securely to prevent access.

Monteringstips / Assembly Advice / Monteringsstips**S**

- Läs monteringsanvisningen noga före montering.
- Montera delarna i den ordningen som anvisas
- Skruvarna bör inte skruvas för hårt tills allt är monterat, i våg och lodat.

OBS! Används elektrisk skruvdragare, kan bulten gå sönder. Hårdra därför manuellt!







- Om lekplatsen placeras vid en gångväg mm bör området säkras mot genomfart av gående och cyklister.
- Inspjningshinder bör placeras runt lekutrustning med stor rörelse, t ex, gungställning.
- Det bör vara fri insyn till lekutrustning beräknat till barn under 3 år.

OBS! Under monteringsarbete bör utrustningen som inte ska förankras i marken, ställs så att den inte kan välta.

Området måste spärras när lekutrustningen byggs upp, med avspärrningsband eller liknande.

NO	Betongkvalitet	C25/30		
SE	Betongkvalitet			
EN	Concrete quality			
NO	Mengde betong		0,1	m ³
SE	Mängd betong			
EN	Amount of concrete			
NO	Fundament størrelse		0.5x0.5x0.4	m
SE	Stiftelsestorlek			
EN	Foundation size			
NO	For sikkerhet må fundamentene med sand eller myk jord være minst 50% større i areal			
SE	För säkerheten måste grunden med sand eller mjuk jord vara minst 50% större i området			
EN	For safety, the foundations with sand or soft soil must be at least 50% larger in area			
NO	Tyngste element	07-255-066	24	Kg
SE	Tyngsta element			
EN	Heaviest element			
NO	Største element	07-255-056	1.4x0.17x0.17	m
SE	Största element			
EN	Biggest element			

Nødvendig verktøy / Tools required / Nödvändiga verktyg





<p>(N)</p> <p>(EN)</p> <p>(S)</p>		<p>Pozidriv</p> 	 <p>13 + 17mm</p> 		
		<p>Metermål</p> <p>Metric measure</p> <p>Tumstoc</p> 		<p>Merkeband</p> <p>Mark ribbon</p> <p>Märkeband</p> 	

Nødvendig antall personer / Number of persons required / Lämpligt antal personer

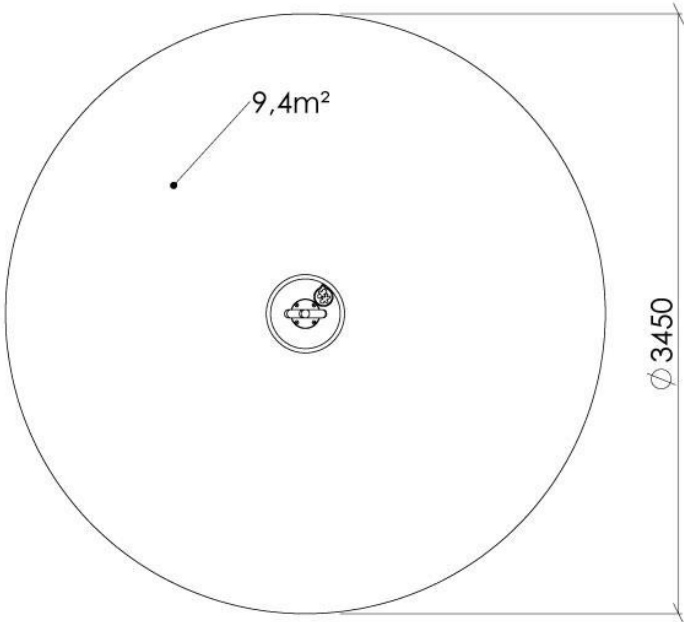
<p>(N)</p> <p>(EN)</p> <p>(S)</p>	
-----------------------------------	---

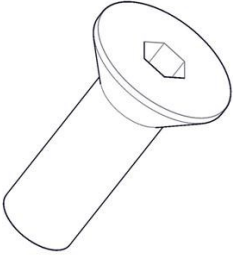
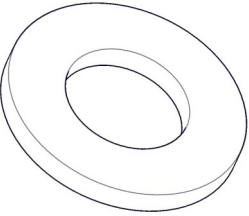
Anbefalt arealbehov ved montering / Recommended working space / Rekommenderad arealbehov vid montering

<p>(N)</p> <p>(EN)</p> <p>(S)</p>	
-----------------------------------	--

Boltepakker for / Boltpackage for / Bultpaket för		Sign. _____.		
Svingstang rød 52-200-030	Navn	Artnr/ dimensjon	Ant	Lev
	Balanseskive for stang montert fundament	07-255-066	1	
	Umbrako M10x50 (4)På montert	04-037-050	0	
	Skive M10 (4)På montert	04-050-010	0	
	Topp sort (1)På montert	00-400-982	0	
	Stang Rød	07-255-056	1	
	Merkeskilt	00-100-400 (Montert hos Søve)	0	

Boltepakker for / Boltpackage for / Bultpaket för

Sign. _____.

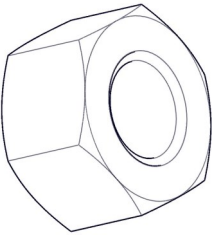
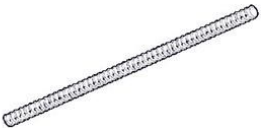
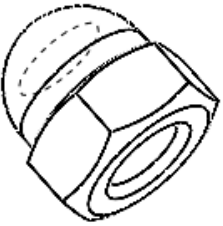
Svingstang rød 52-200-030	Navn	Artnr/ dimensjon	Ant	Lev
	M10 låsemutter (4)På montert	04-040-010	0	
	Armering	03-191-013	2	
	Hettemutter M10	04-048-010	4	

Fundamentering med betong // Foundation concrete // Förankring med betong

(N)

Støtsand



(N)

Bakkenivå

(EN)

Ground level

(S)

Marknivå

(EN)

Safer surface

(S)

Stridsan

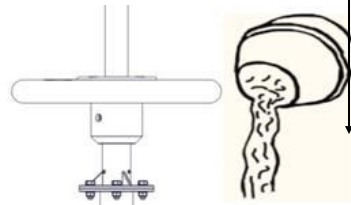

Ref NS-EN 1177

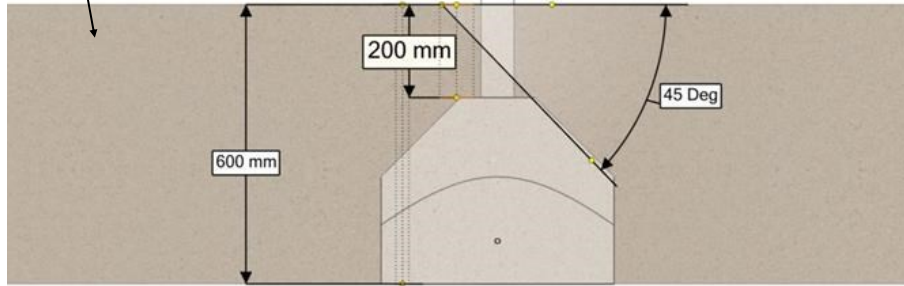

(N)

Komprimert masse.

betong

(EN)

Compressed mass.

concrete

(S)

Komprimerad massa.

betong

(N)

Alle mål er oppgitt i millimeter

(EN)

Scale measured in mm

(S)

Alla mått är i millimeter.

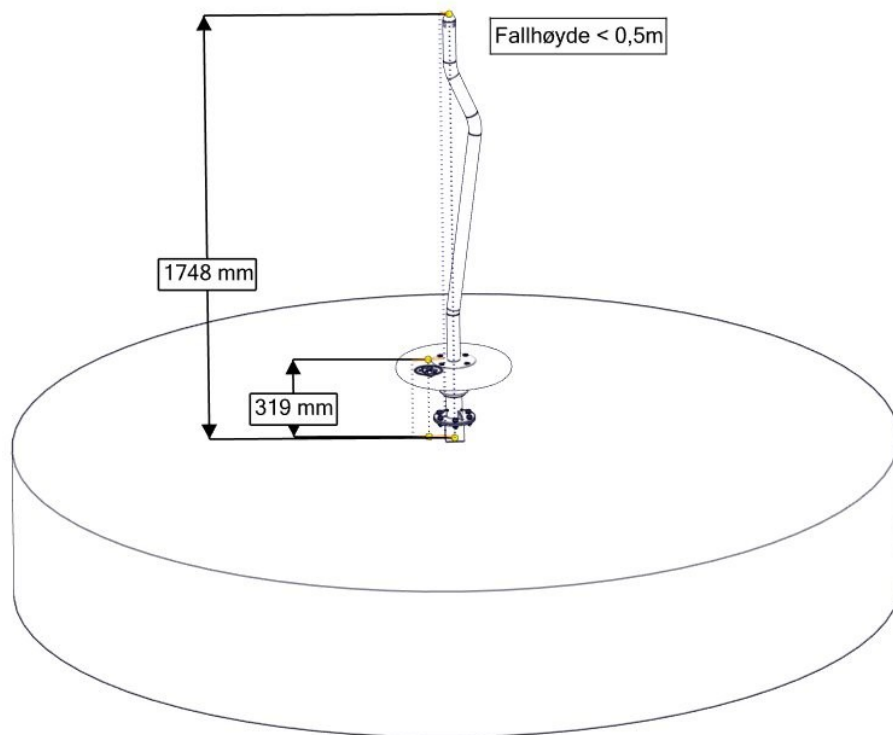
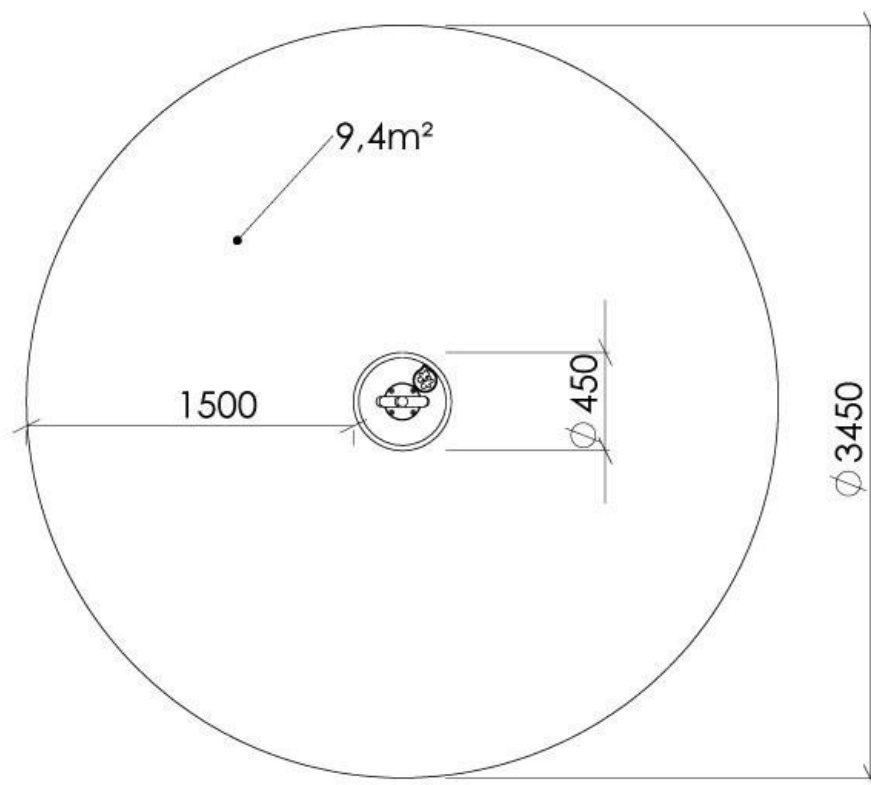
Fallhøyder / Free height of fall / Fallhöjder**Sikkerhetszone / Safety zone / Säkerhetszon**

Montering av lekeapparatet / Assembly instructions / Montering av lekredskapet

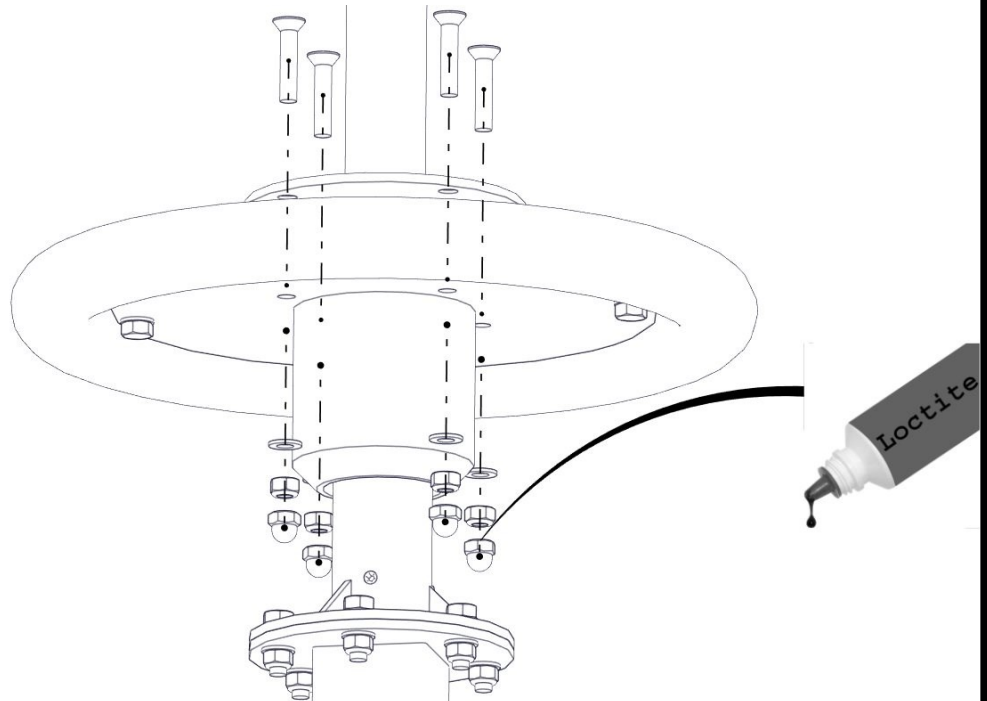

Part Name	Article nr.	Qty
Unbrakoskrue m/nedsenk hode M10x50	04-037-050	4
Søve spinner, svingstang med fot	07-255-056	1
Søve spinner, forankringsstolpe rett	07-255-066	1
Skive M10	04-050-010	4



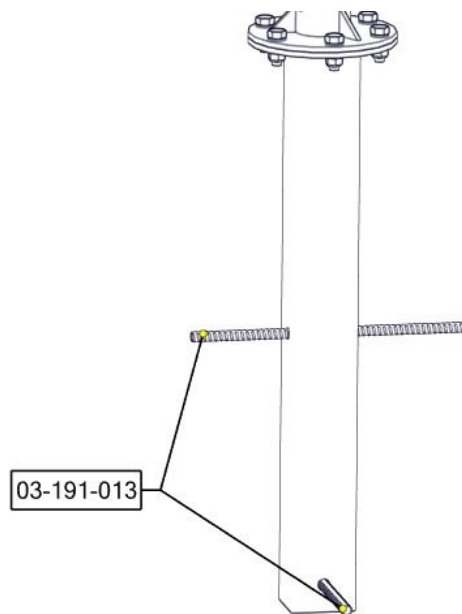

Part Name	Article nr.	Qty
Låsemutter M10	04-040-010	4
Hettemutter M10	04-048-010	4

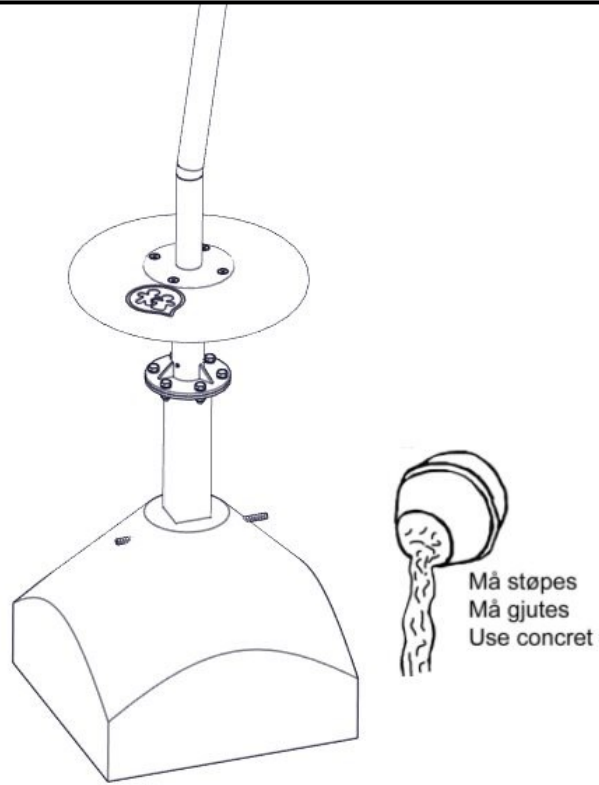

Part Name	Article nr.	Qty
Armering	03-191-013	2

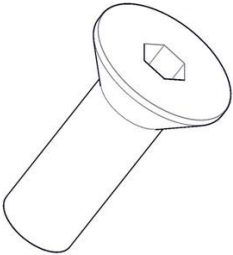
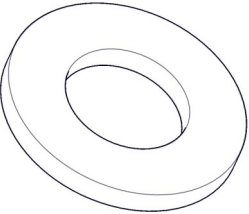

Før utstyret tas i bruk / Before play begins / Innan lekredskapet tas i bruk	
N	<ul style="list-style-type: none">● Påse at fallunderlag er utlagt i henhold til gjeldende regler eller vår anbefaling● Fjern alle monteringshjelpemidler (rester av betong, planker, paller, plast, og lignende)● Før utstyret tas i bruk, burde man sjekke at det ikke er fare for at anorakksnorer og lignende som kan hekte seg fast noen steder på lekeapparatet. (Vedlagte snor med dobbe (kneledd) kan brukes til å sjekke at dette er i orden. Se vedlagte veiledning for bruk av denne. Dette gjøres for å oppdage eventuelle feilmonteringer.?)● NB! Bør stå i 2-3 dager før bruk
EN	<ul style="list-style-type: none">● Make sure the area and depth of safer surfacing are according to the current standard, or to the manufacturer's recommendation● Make sure all tools and surplus materials are removed before play begins● PS! When complete, allow 2-3 days for the concrete to set before use
S	<ul style="list-style-type: none">● Kontrollera att fallunderlag är utlagt enligt gällande regler eller vårt rekommendation● Ta bort alla monteringshjälpmedel (rester av betong, plankor, pallar, plast och liknande)● Innan lekredskapet används, kontrollera att anoracksnoddar eller kläder/delar av kläder eller liknande inte kan fastna i några delar på redskapet. (Den bipackade "knävringen" kan man med fördel användas för denna kontroll.● Detta görs för att upptäcka eventuella felmonteringar.)

Boltepakker for / Boltpackage for / Bultpaket för		Sign. _____.		
Svingstang rød 52-200-030	Navn	Artnr/ dimensjon	Ant	Lev
	Balanseskive for stang montert fundament	07-255-066	1	
	Umbrako M10x50 (4)På montert	04-037-050	0	
	Skive M10 (4)På montert	04-050-010	0	
	Topp sort (1)På montert	00-400-982	0	
	Stang Rød	07-255-056	1	
	Merkeskilt	00-100-400 (Montert hos Søve)	0	

Boltepakker for / Boltpackage for / Bultpaket för

Sign. _____.

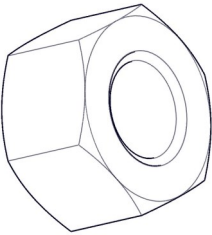
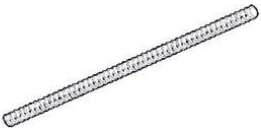
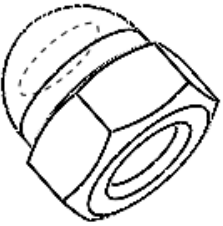
Svingstang rød 52-200-030	Navn	Artnr/ dimensjon	Ant	Lev
	M10 låsemutter (4)På montert	04-040-010	0	
	Armering	03-191-013	2	
	Hettemutter M10	04-048-010	4	

25.08.2022

4 stk Hettemutter med Loctite under sete.
MNØ