

**N****Monteringsanvisning****EN****Assembly Instructions****S****Monteringsanvisning**

Produkt nr. / Product no. / Produkt nr.

**00-400-182K**

Sort

Ord. nr. \_\_\_\_\_

Dato. \_\_\_\_\_



Sign. \_\_\_\_\_

**søve**

Søve AS  
Grønnvoldveien 290  
3830 Ulefoss - Norway  
Tlf: +47 35 94 65 65  
[www.sove.no](http://www.sove.no)

**søve**

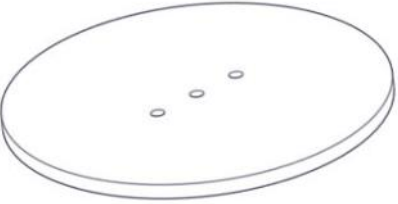
Søve AB  
EA Rosengrensgatan 32  
421 31 Västra Frölunda  
Phone: +46 (0)31 773 97 00  
[www.sove.se](http://www.sove.se)

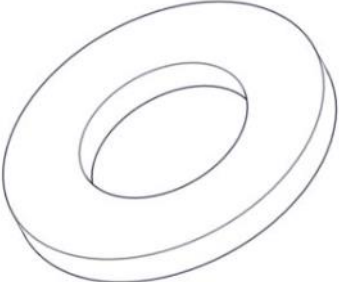
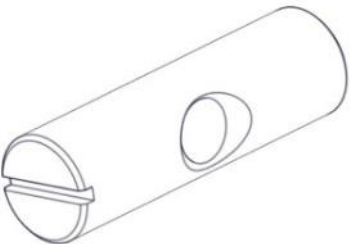
| <b>Boltepakker for / Boltpackage for / Bultpaket för</b>                            |  | Sign. _____     |     |     |
|---|--|-----------------|-----|-----|
| <b>Brannrør<br/>00-400-182K</b>   | Navn                                   | Artnr/dimensjon | Ant | Lev |
|    | Brannrør<br>For gulvhøyde 1.4m<br>Sort | 00-400-182      | 1   |     |
|    | Fundamentplate                         | 00-003-103      | 1   |     |
|   | Torx M8x35                             | 04-000-035      | 2   |     |
|  | Låsemutter M8                          | 04-040-008      | 2   |     |
|  | Skive M8                               | 04-050-008      | 2   |     |
|  | Hylsemutter<br>Ø12x40 1xM8             | 04-019-040      | 1   |     |

**Boltepakker for / Boltpackage for / Bultpaket för**

Sign. \_\_\_\_\_.

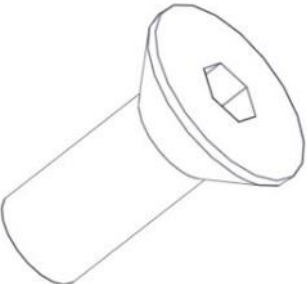
| Brannrør<br>00-400-182K   | Navn                            | Artnr/dimensjon | Ant | Lev |
|---|---------------------------------|-----------------|-----|-----|
|  | Unbrako M8x50<br>Forsenket hode | 04-034-050      | 1   |     |
|   |                                 |                 |     |     |
|   |                                 |                 |     |     |
|   |                                 |                 |     |     |
|   |                                 |                 |     |     |
|   |                                 |                 |     |     |

## Montering av lekeapparatet / Assembly instructions / Montering av lekredskapet



| nr | PartName        | Artnr      | Antall |
|----|-----------------|------------|--------|
| 1  | Brannrør        | 00-400-182 | 1      |
| 2  | Fundament plate | 00-003-103 | 1      |
| 3  | Torx M8x35      | 04-000-035 | 2      |

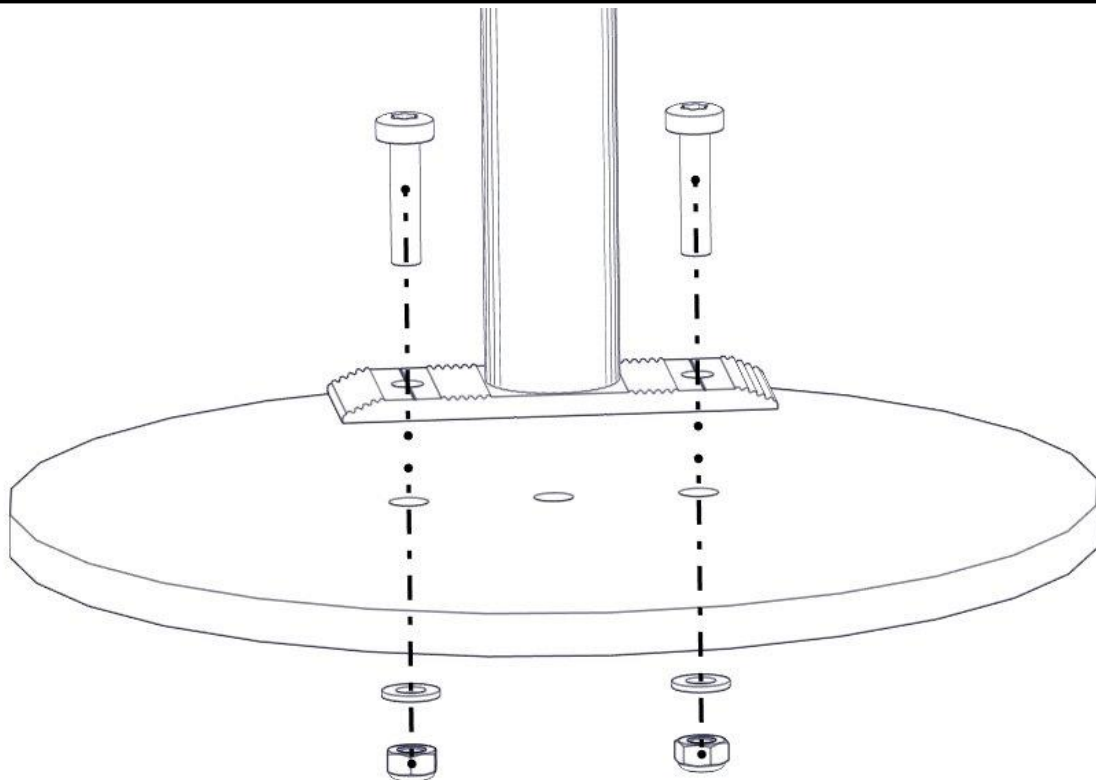

| nr | PartName      | Artnr      | Antall |
|----|---------------|------------|--------|
| 4  | Låsemutter M8 | 04-040-008 | 2      |
| 5  | Skive M8      | 04-050-008 | 2      |

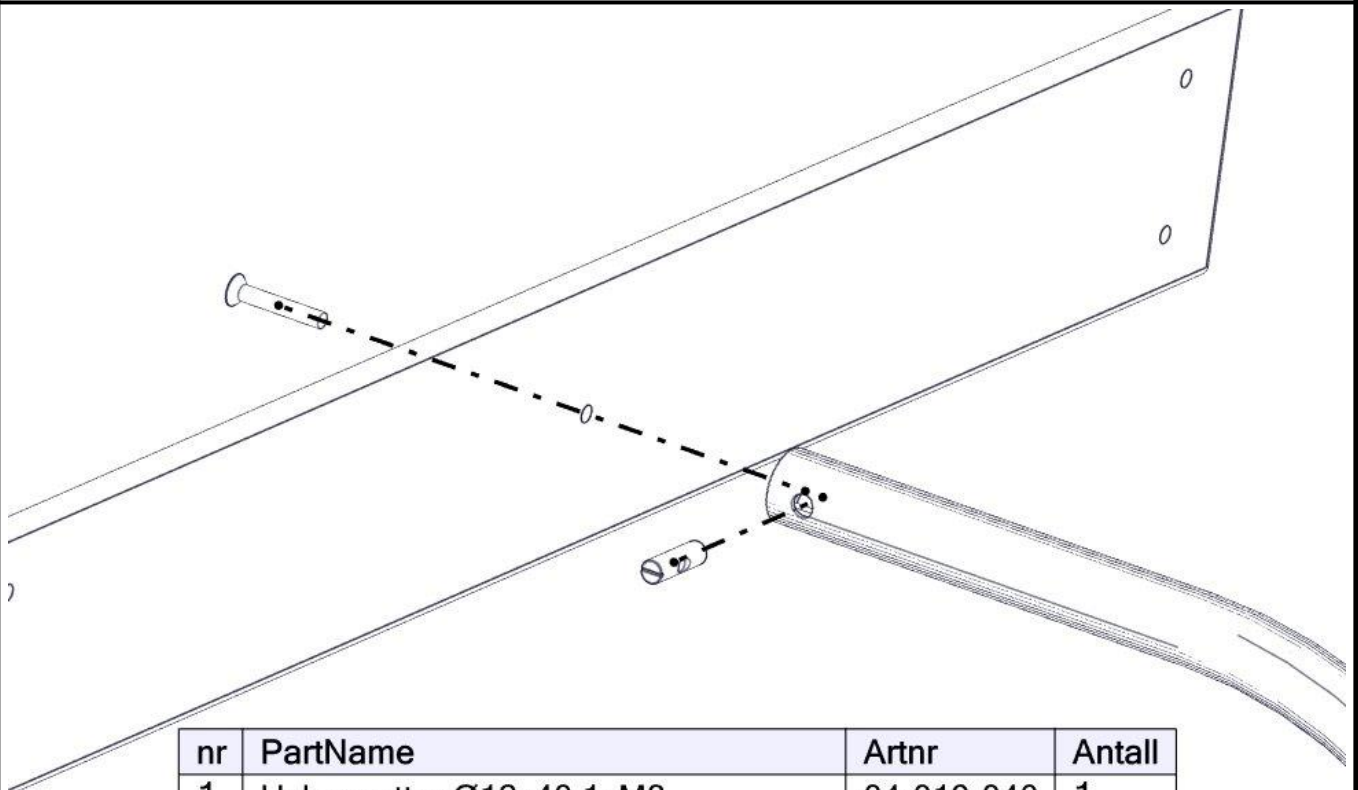

**Montering av lekeapparatet / Assembly instructions / Montering av lekredskapet**

| nr | PartName                           | Artnr      | Antall |
|----|------------------------------------|------------|--------|
| 1  | Hylsemutter Ø12x40 1xM8            | 04-019-040 | 1      |
| 2  | Unbrako skrue M8x50 forsenket hode | 04-034-050 | 1      |

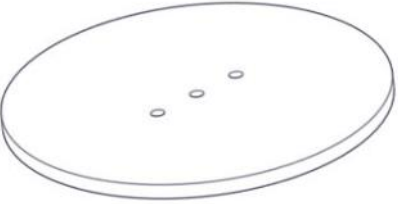

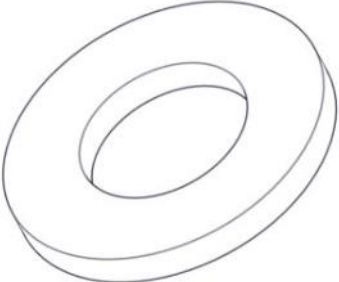
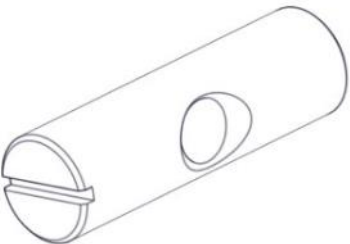
| <b>Boltepakker for / Boltpackage for / Bultpaket för</b>                            |  | Sign. _____     |     |     |
|---|--|-----------------|-----|-----|
| <b>Brannrør<br/>00-400-182K</b>   | Navn                                   | Artnr/dimensjon | Ant | Lev |
|    | Brannrør<br>For gulvhøyde 1.4m<br>Sort | 00-400-182      | 1   |     |
|    | Fundamentplate                         | 00-003-103      | 1   |     |
|   | Torx M8x35                             | 04-000-035      | 2   |     |
|  | Låsemutter M8                          | 04-040-008      | 2   |     |
|  | Skive M8                               | 04-050-008      | 2   |     |
|  | Hylsemutter<br>Ø12x40 1xM8             | 04-019-040      | 1   |     |

**Boltepakker for / Boltpackage for / Bultpaket för**

Sign. \_\_\_\_\_.

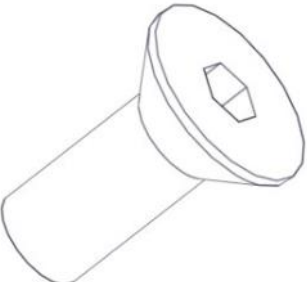
| Brannrør<br>00-400-182K   | Navn                            | Artnr/dimensjon | Ant | Lev |
|---|---------------------------------|-----------------|-----|-----|
|  | Unbrako M8x50<br>Forsenket hode | 04-034-050      | 1   |     |
|   |                                 |                 |     |     |
|   |                                 |                 |     |     |
|   |                                 |                 |     |     |
|   |                                 |                 |     |     |
|   |                                 |                 |     |     |
|   |                                 |                 |     |     |