

**Monteringsanvisning****Assembly Instructions****Monteringsanvisning**

Produkt nr. / Product no. / Produkt nr.

**00-400-803K****Sort**

Ord. nr. \_\_\_\_\_

Dato. \_\_\_\_\_

Sign. \_\_\_\_\_

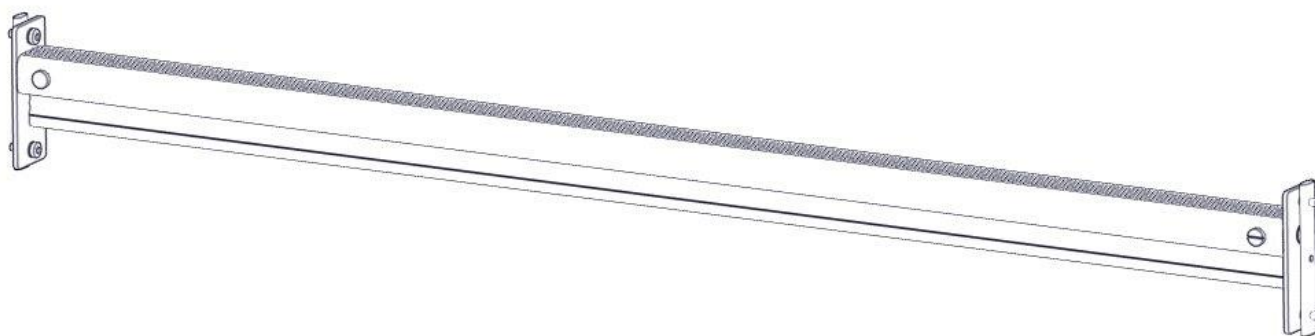
**søve**



Søve AS  
Grønnvoldveien 290  
3830 Ulefoss - Norway  
Tlf: +47 35 94 65 65  
[www.sove.no](http://www.sove.no)

**søve**

Søve AB  
EA Rosengrensgatan 32  
421 31 Västra Frölunda  
Phone: +46 (0)31 773 97 00  
[www.sove.se](http://www.sove.se)

**Boltepakker for / Boltpackage for / Bultpaket för**

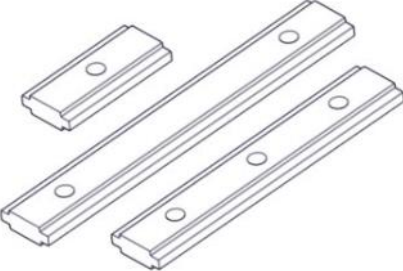
Sign. \_\_\_\_\_.

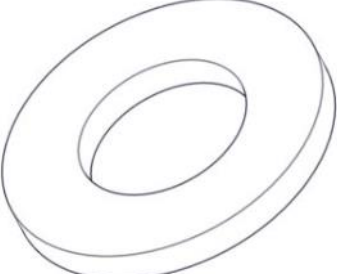

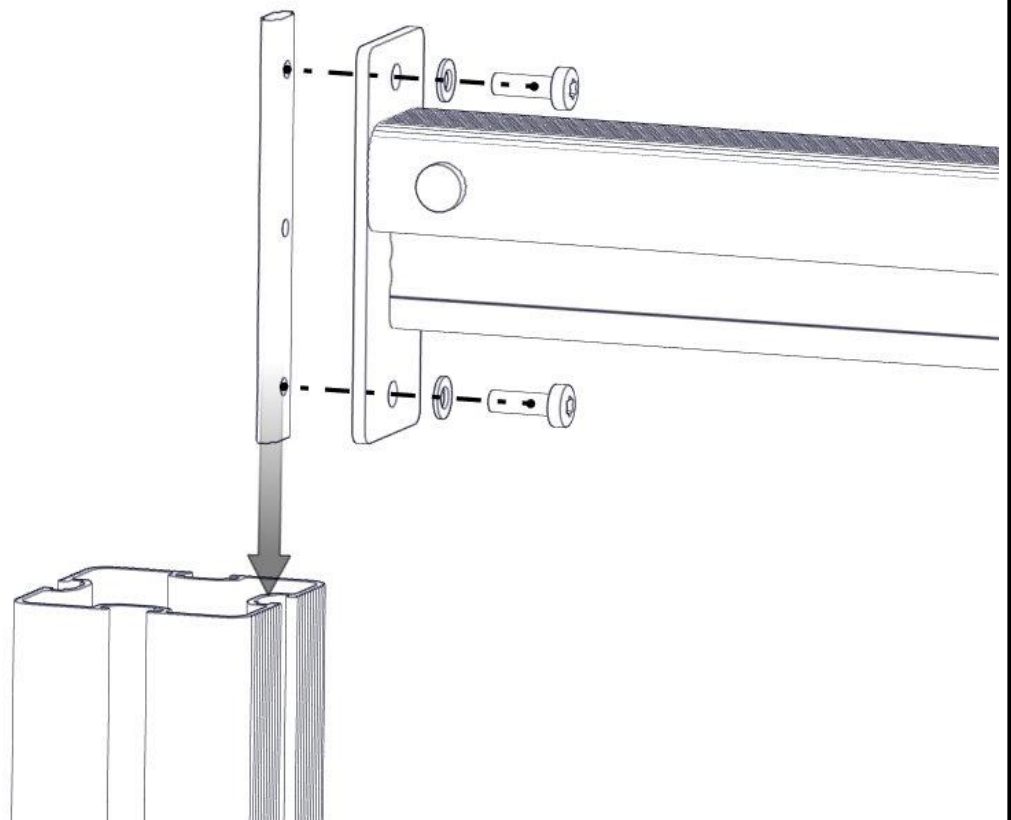
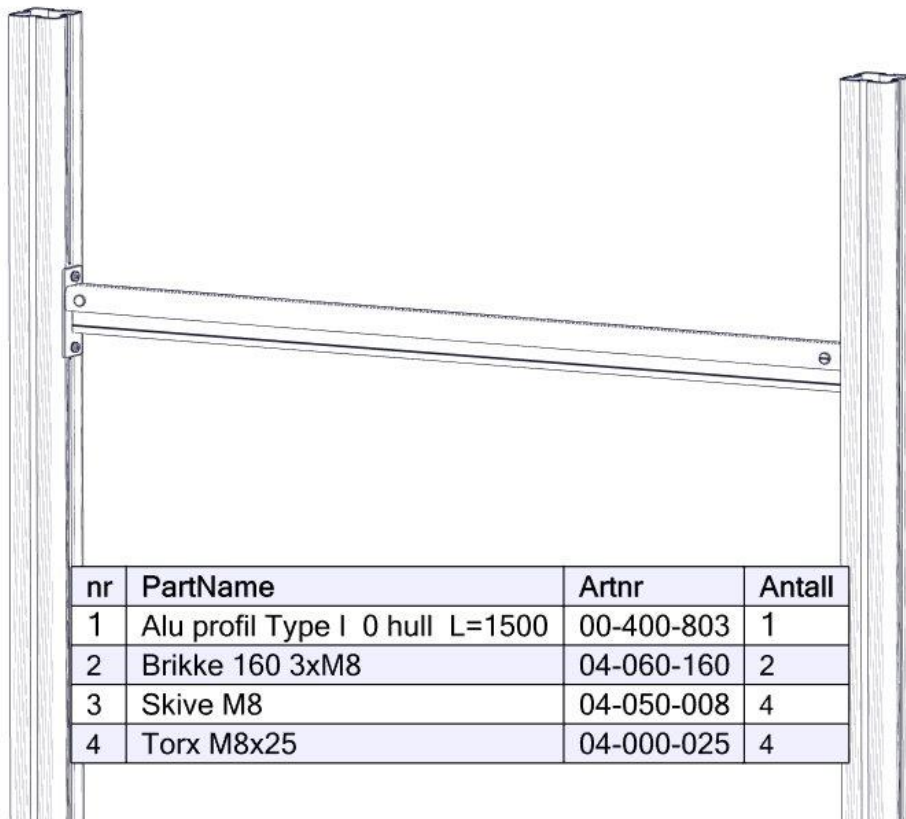
Alu profil Type I uten hull 00-400-803K	Navn	Artnr/ dimensjon	Ant	Lev
	Alu profil Type I L = 1500 Uten hull Sort	00-400-803	1	
	Brikke 160 3xM8	04-060-160	2	
	Torx M8x25	04-000-025	4	
	Skive M8	04-050-008	4	

**Montering av lekeapparatet / Assembly instructions / Montering av lekredskapet**

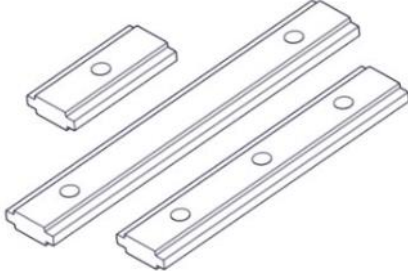

**Boltepakker for / Boltpackage for / Bultpaket för**

Sign. \_\_\_\_\_.

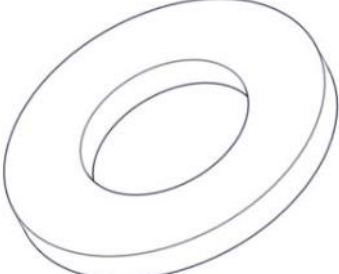
Alu profil Type I uten hull 00-400-803K	Navn	Artnr/ dimensjon	Ant	Lev
	Alu profil Type I L = 1500 Uten hull Sort	00-400-803	1	
	Brikke 160 3xM8	04-060-160	2	
	Torx M8x25	04-000-025	4	
	Skive M8	04-050-008	4	