

**Monteringsanvisning****Assembly Instructions****Monteringsanvisning**

Produkt nr. / Product no. / Produkt nr.

00-400-817K**Sort**

Ord. nr. _____

Dato. _____

Sign. _____

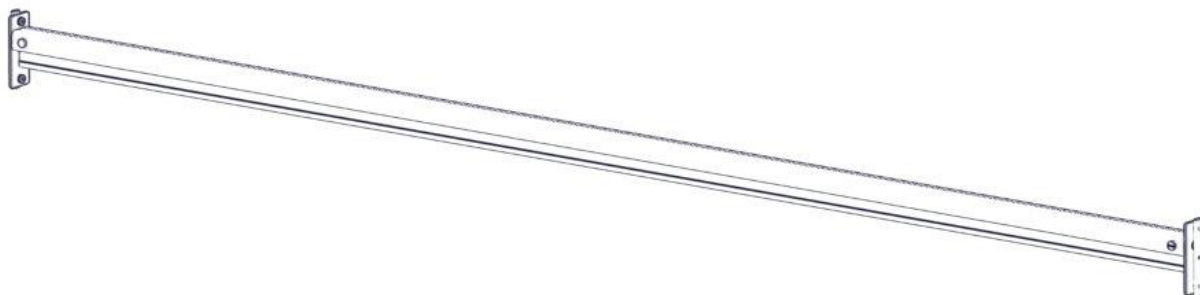
**søve**



Søve AS
Grønnvoldveien 290
3830 Ulefoss - Norway
Tlf: +47 35 94 65 65
www.sove.no

**søve**

Søve AB
EA Rosengrensgatan 32
421 31 Västra Frölunda
Phone: +46 (0)31 773 97 00
www.sove.se

Boltepakker for / Boltpackage for / Bultpaket för

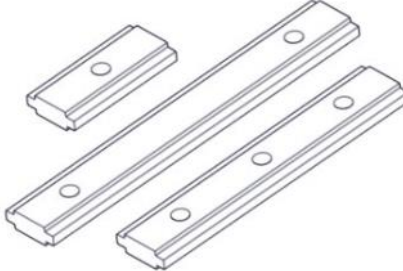
Sign. _____.

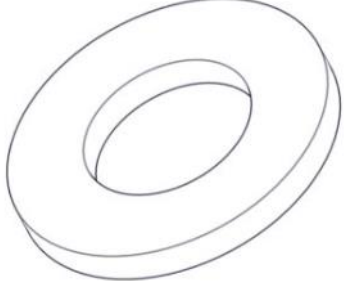
Drager 00-400-817K	Navn	Artnr/ dimensjon	Ant	Lev
	Drager uten hull L = 3000 Sort	00-400-817	1	
	Brikke 160 3xM8	04-060-160	2	
	Torx M8x25	04-000-025	4	
	Skive M8	04-050-008	4	

Montering av lekeapparatet / Assembly instructions / Montering av lekredskapet

Se på hovedmontering for posisjon
 Look at main assembly for position
 Titta på hovudmontering för position

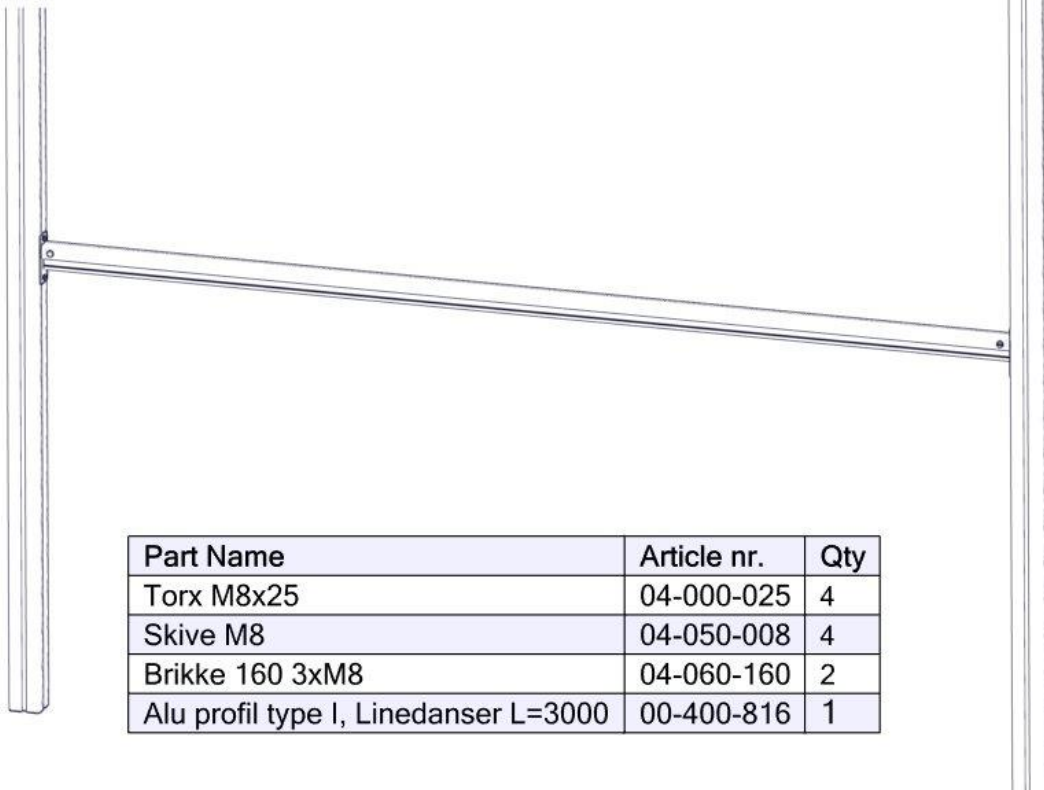

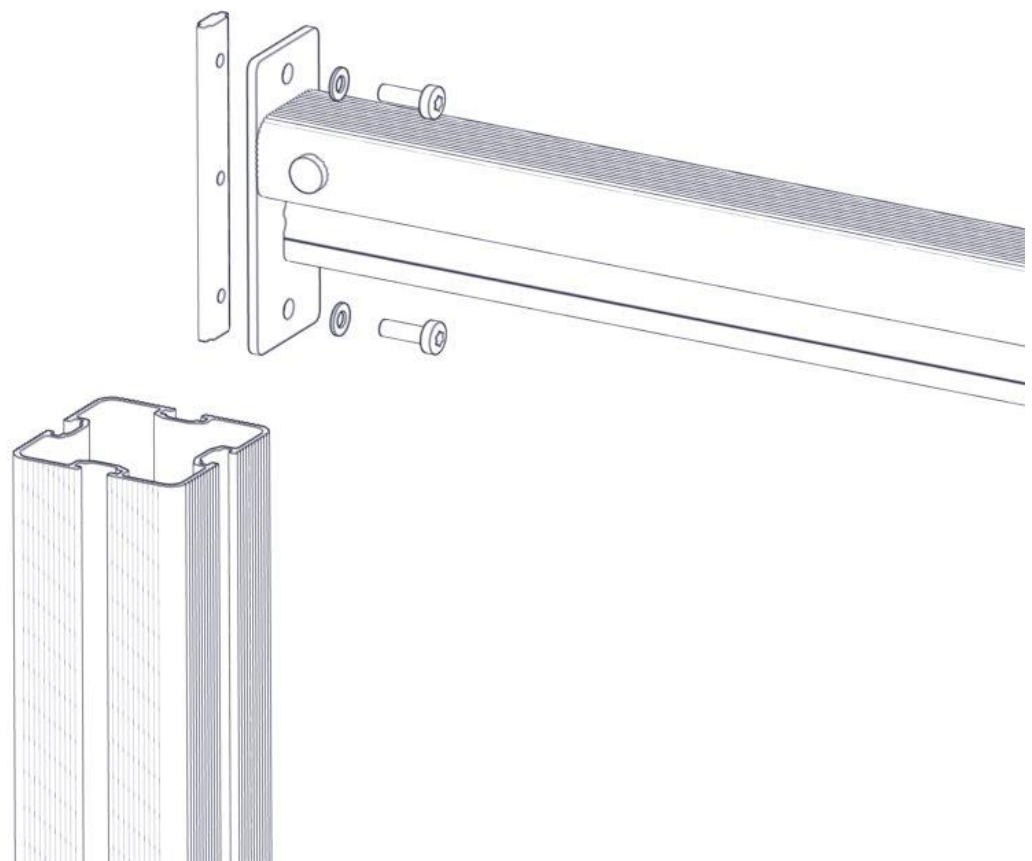

Part Name	Article nr.	Qty
Torx M8x25	04-000-025	4
Skive M8	04-050-008	4
Brikke 160 3xM8	04-060-160	2
Alu profil type I, Linedanser L=3000	00-400-816	1

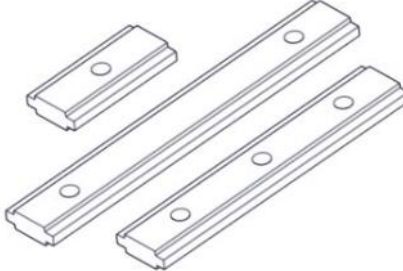

Boltepakker for / Boltpackage for / Bultpaket för

Sign. _____.

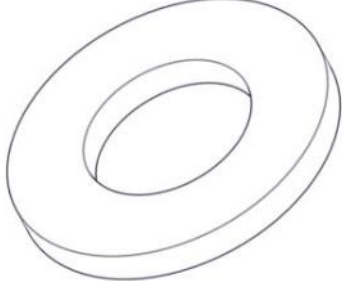
Drager 00-400-817K	Navn	Artnr/ dimensjon	Ant	Lev
	Drager uten hull L = 3000 Sort	00-400-817	1	
	Brikke 160 3xM8	04-060-160	2	
	Torx M8x25	04-000-025	4	
	Skive M8	04-050-008	4	