

N**Monteringsanvisning****EN****Assembly Instructions****S****Monteringsanvisning**

Produkt nr. / Product no. / Produkt nr.

01-125-118K**BlåGrønn**

Ord. nr. _____

Dato. _____



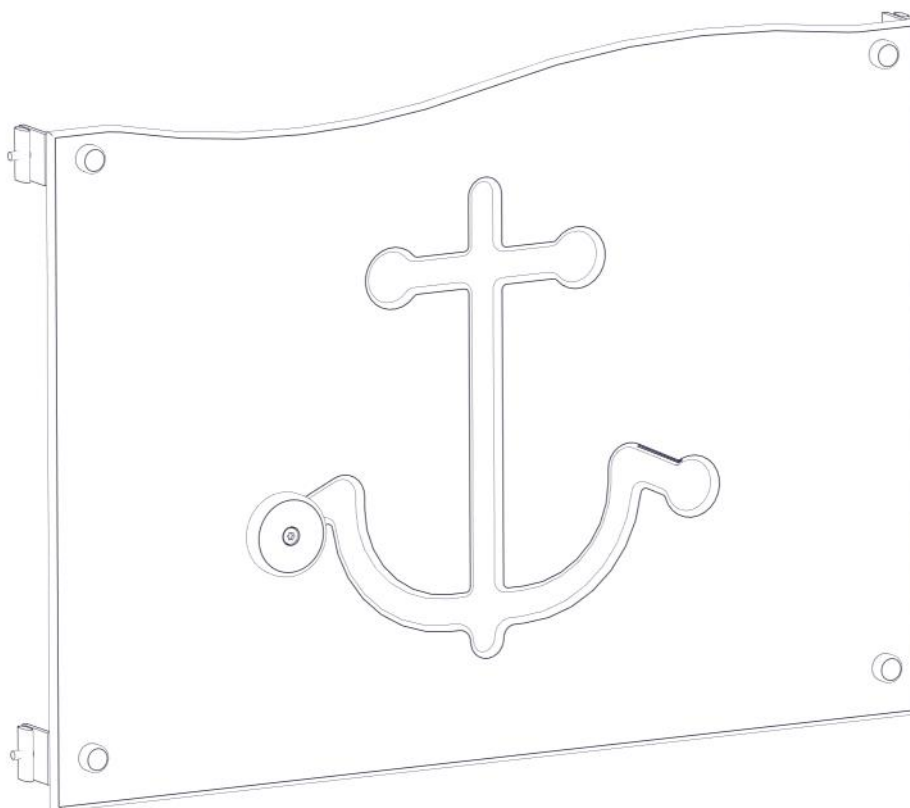

Sign. _____

**søve**

Søve AS
Grønnvoldveien 290
3830 Ulefoss - Norway
Tlf: +47 35 94 65 65
www.sove.no

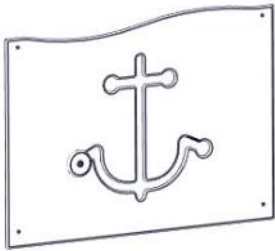
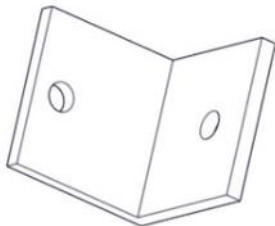

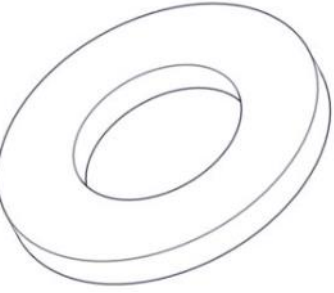
**søve**

Søve AB
EA Rosengrensgatan 32
421 31 Västra Frölunda
Phone: +46 (0)31 773 97 00
www.sove.se

Boltepakker for / Boltpackage for / Bultpaket för		Sign. _____		
Vegg m/spill BlåGrønn 01-125-118K	Navn	Artnr/dimensjon	Ant	Lev
	Rekkverk m/spill Montert 940 x 685 x 12 BlåGrønn	01-125-118	1	
	Vinkel 50 x 50 x 50 x 5 9 mm hull	04-075-050	4	
	Torx M8x25	04-000-025	4	
	Torx M8x30	04-000-030	4	
	Låsemutter M8	04-040-008	4	
	Skive M8	04-050-008	4	
	Endedeksel M8 Flat kropp Sort	05-301-033	4	

Boltepakker for / Boltpackage for / Bultpaket för

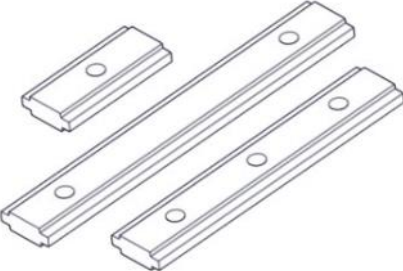
Sign. _____.

Vegg m/spill BlåGrønn 01-125-118K	Navn	Artnr/dimensjon	Ant	Lev
	Brikke 50 1xM8	04-060-050	4	
	Endedeksel M8 Hode Sort	05-301-033	4	

Montering av lekeapparatet / Assembly instructions / Montering av lekredskapet

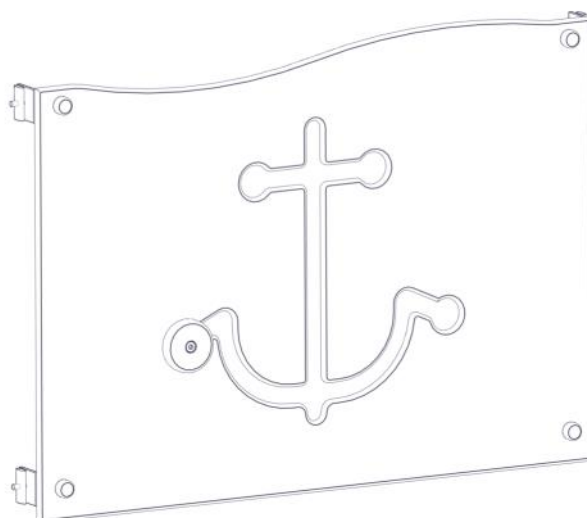

PartName	Artnr	Antall
Brikke 50 1XM8	04-060-050	4
Endedeksel flat M8 sort	05-301-033	8
Låsemutter M8	04-040-008	4
Rekkverk 940x665x12 m/spill	01-125-118	1
Skive M8	04-050-008	4



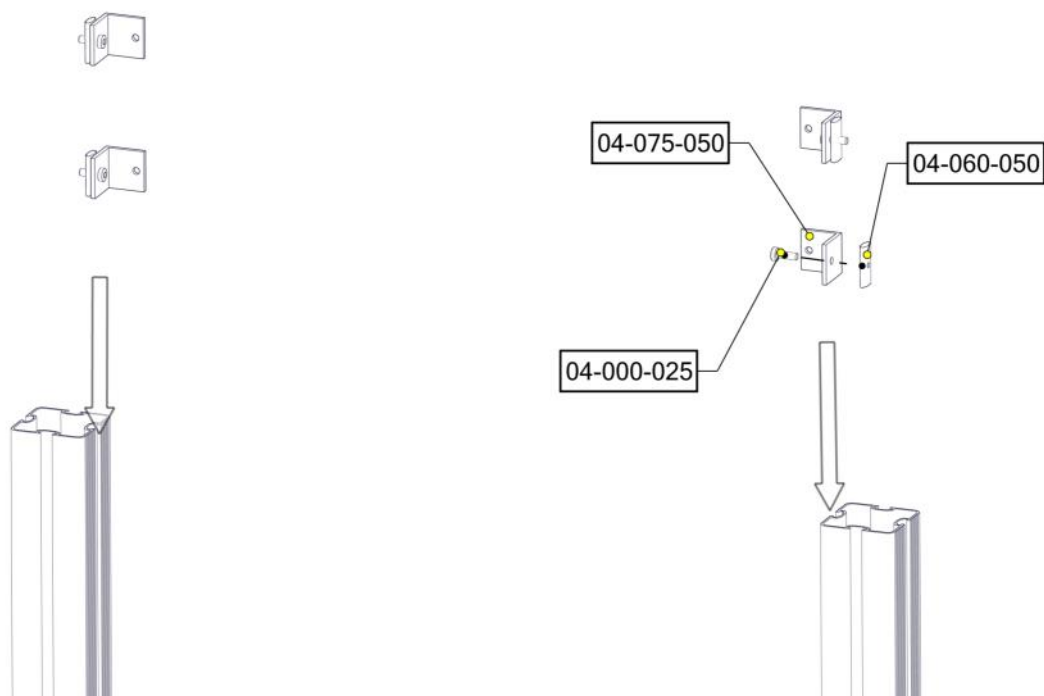

PartName	Artnr	Antall
Torx M8x25	04-000-025	4
Torx M8x30	04-000-030	4
Vinkel 50x50x50x5 9mm hull	04-075-050	4

Se på hovedmontering for posisjon
 Look at main assembly for position
 Titta på hovudmontering för position

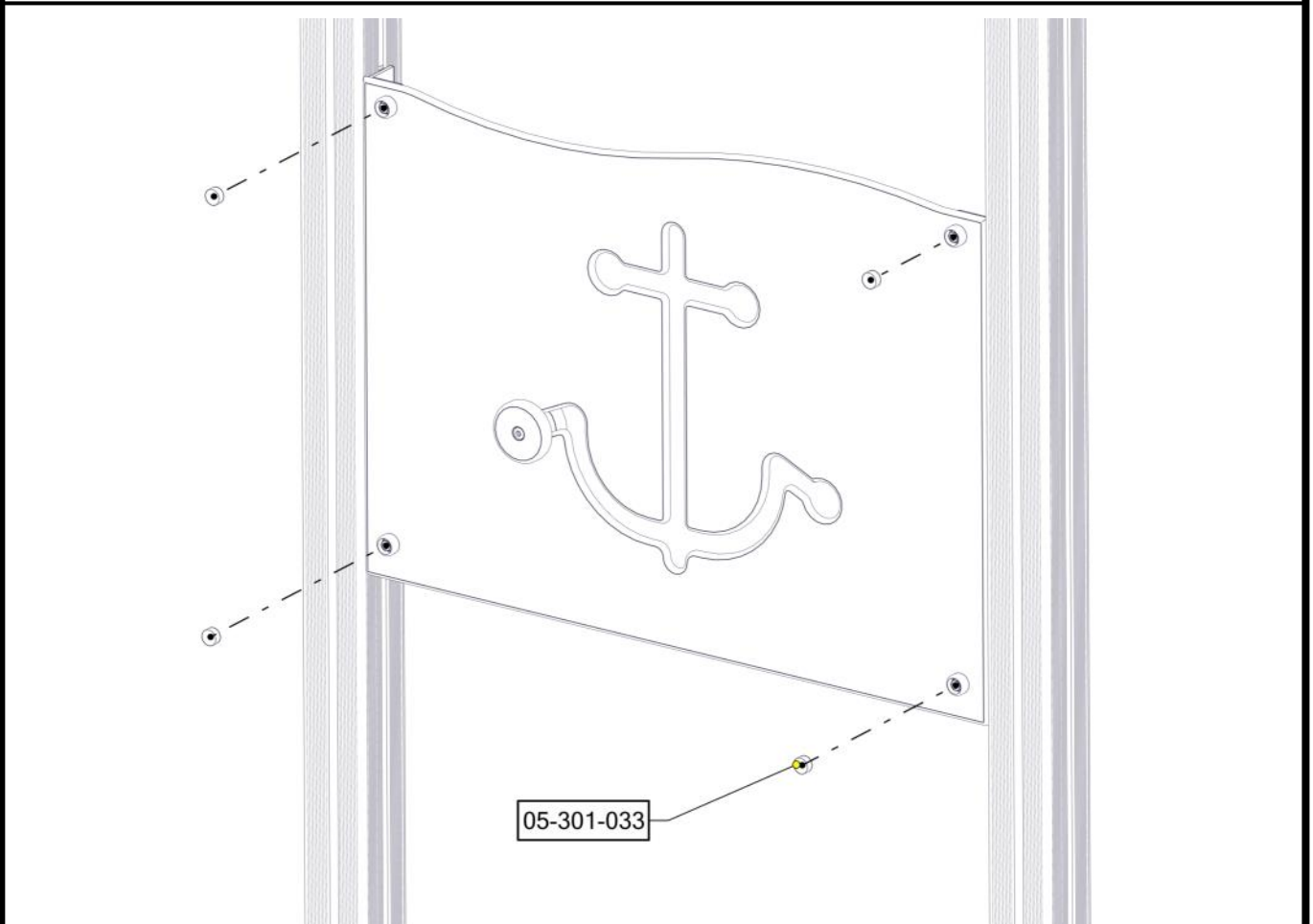
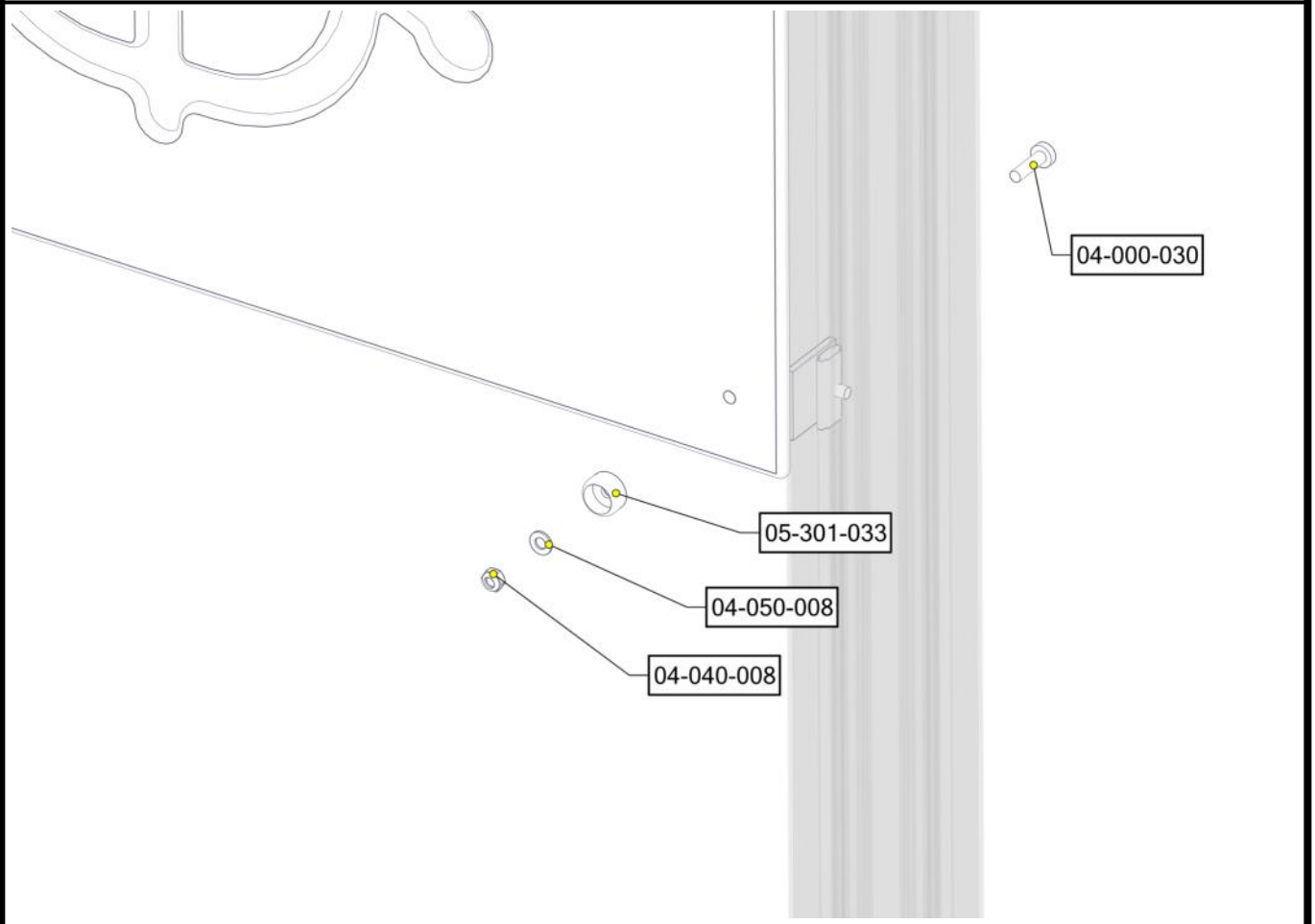

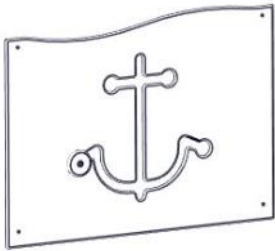
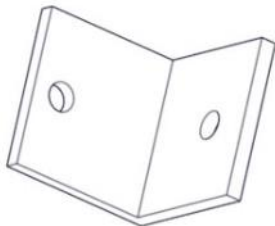

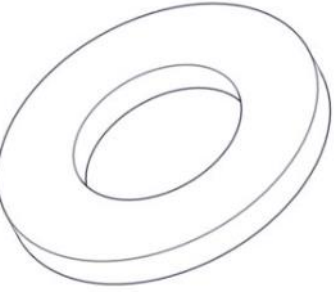
Montering av lekeapparatet / Assembly instructions / Montering av lekredskapet



Boltepakker for / Boltpackage for / Bultpaket för		Sign. _____		
Vegg m/spill BlåGrønn 01-125-118K	Navn	Artnr/dimensjon	Ant	Lev
	Rekkverk m/spill Montert 940 x 685 x 12 BlåGrønn	01-125-118	1	
	Vinkel 50 x 50 x 50 x 5 9 mm hull	04-075-050	4	
	Torx M8x25	04-000-025	4	
	Torx M8x30	04-000-030	4	
	Låsemutter M8	04-040-008	4	
	Skive M8	04-050-008	4	
	Endedeksel M8 Flat kropp Sort	05-301-033	4	

Boltepakker for / Boltpackage for / Bultpaket för

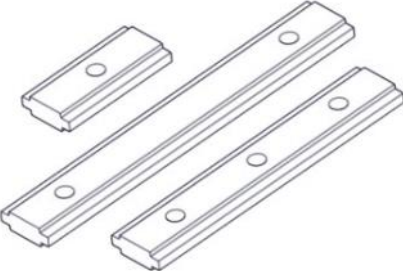
Sign. _____.

Vegg m/spill BlåGrønn 01-125-118K	Navn	Artnr/dimensjon	Ant	Lev
	Brikke 50 1xM8	04-060-050	4	
	Endedeksel M8 Hode Sort	05-301-033	4	