



**Monteringsanvisning**



**Assembly Instructions**



**Monteringsanvisning**

Produkt nr. / Product no. / Produkt nr.

**01-129-090**

Ordr. nr. \_\_\_\_\_

Dato. \_\_\_\_\_

Sign. \_\_\_\_\_



**Søve Lekemiljø AS**

3830 Ulefoss - Norway

Tlf: +47 35 94 65 65

[www.sove.no](http://www.sove.no)



**Søve AB**

Fabriksgatan 7

412 50 Göteborg

Phone: +46 (0)31 773 97 00

[www.sove.se](http://www.sove.se)

## Monteringstips / Assembly Advice / Monteringsstips

N

- Les monteringsanvisningen nøye før montering.
- Monter elementene i rekkefølgen som vist.
- Boltene bør ikke skrues for hardt til før alt er montert, vatret og loddet. Skru så boltene til.
- NB! Ved bruk av drill, kan boltene ryke.
- På grunn av at solen kan gjøre rutsjeflaten veldig varm, bør rutsjebanens utløp vende mot nord-øst eller nord-vest.
- Er lekeutstyret plassert i naturlige ferdselstraséer må området sikres mot spontan gjennomgang.
- Innspringningshinder bør vurderes rundt lekeapparater hvor det er stor bevegelse, f.eks.
  - ved huskestativ.
- Det bør være fritt innsyn til lekeutstyr som er beregnet for barn under 3 år.

**NB! Under monteringsarbeidet må utstyr, som ikke er forankret forsvarlig i bakken, avstives slik at det ikke velte. Området må avstenges under oppsettelse av apparatene med sperrebånd eller lignende.**

UK

- Read the instruction carefully before assembling the play unit.
- Assemble the components in the sequence shown in these instructions.
- Fixings must not be fully tightened during assembly. Before casting the foundations, the structure must be level and plumb, at which point all fixings are tightened.
- PS! If use of drill, the bolts may be wrecked.
- Avoid positioning the slide facing due south because of overheating – ideal positions are facing north-east or north-west.
- Secure the construction-area to prevent people from walking through it.
- Consider installing barriers around play-equipment which gives rise to a lot of activity – i.e. swings.
- Ensure that clear vision is possible across the play area so that supervision is possible from any position, particularly where children under 3 years of age will be playing.

**NB! During assembly of the equipment, ensure that all structures are securely propped, especially when left overnight. Also ensure that equipment is supported whilst concrete foundations are setting and enclose the area securely to prevent access.**

**Monteringstips / Assembly Advice / Monteringsstips**









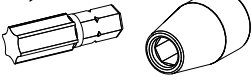

S

- Läs monteringsanvisningen noga före montering.
  - Montera delarna i den ordningen som anvisas
  - Skruvarna bör inte skruvas för hårt tills allt är monterat, i våg och lodat.
- OBS! Används elektrisk skruvdragare, kan bulten gå sönder. Hårdra därför manuellt!
- Solen kan göra att rutchbanan blir väldigt varm. Banans nedfart rekommenderas att vändas i norrlig riktning
  - Om lekplatsen placeras vid en gångväg mm bör området säkras mot genomfart av gående och cyklister.
  - Inspringningshinder bör placeras runt lekutrustning med stor rörelse, t ex, gungställning.
  - Det bör vara fri insyn till lekutrustning beräknat till barn under 3 år.

**OBS! Under monteringsarbete bör utrustningen som inte ska förankras i marken, ställs så att den inte kan välta.**

**Området måste spärras när lekutrustningen byggs upp, med avspärrningsband eller liknande.**

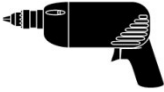
**Nødvendig verktøy / Tools required / Nödvändiga verktyg**

<p>(N)</p> <p>(UK)</p> <p>(S)</p>	<p>(A)</p> 	<p>(B)</p>  <p>Torx Nr 45 High quality</p> 	<p>(C)</p> <p>5 mm 6 mm</p> 	<p>(D)</p> 	<p>(E)</p> 
		<p>Metermål Metric measure Tumstoc</p> 	<p>16 V</p> 	<p>Merkebånd Mark ribbon Märkeband</p> 	<p>13 + 17mm</p> 

**Nødvendig antall personer / Number of persons required / Lämpligt antal personer**







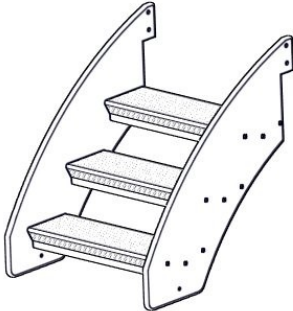

<p>(N)</p> <p>(UK)</p> <p>(S)</p>	
-----------------------------------	---

**Anbefalt arealbehov ved montering / Recommended working space / Rekommenderad arealbehov vid montering**

<p>(N)</p> <p>(UK)</p> <p>(S)</p>	Empty space for recommended working space
-----------------------------------	---

**Boltepakker for / Boltpackage for / Bultpaket för**

Sign. \_\_\_\_\_

Trapp 950	Ant= 1	Navn	Artnr/dimensjon	Ant	Lev
		Trapp 550	01-290-090	1	
		Steun liten (2)	00-100-310	2	
		Brikke 90 2T (2)	04-060-090	2	
		Torx M8x35(4)	04-000-035	10	
		Fundament plate (2)	00-003-106	2	
		Skive M8	04-050-008	6	
		Mutter M8	04-040-008	6	

**Fundamentering uten betong / Foundation without concrete / Förankring utan betong**

(N)

Støtsand

(N)

Bakkenivå

(UK)

Ground level

(S)

Marknivå

(UK)

Safer surface

(S)

Stridsan

(N)

Komprimert masse

Støpefri nedgraving

(UK)

Compressed mass

Concrete-free anchor

(S)

Komprimerad massa

Nedgrävningfundament

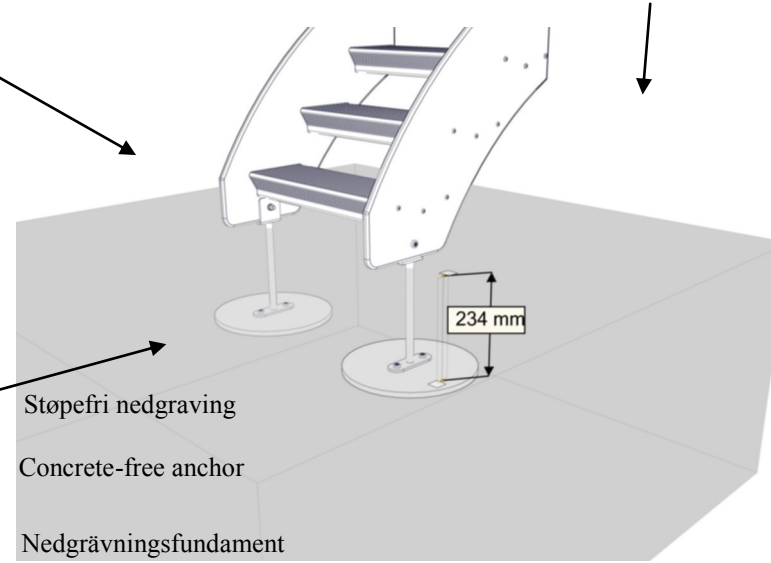

(N)

Bolten skrues HELT igjennom aluminiumen.

(UK)

The bolt must be tightened in to the post, so that it pierces the aluminium

(S)

Bulten skruvas HELT igjennom aluminiumen.

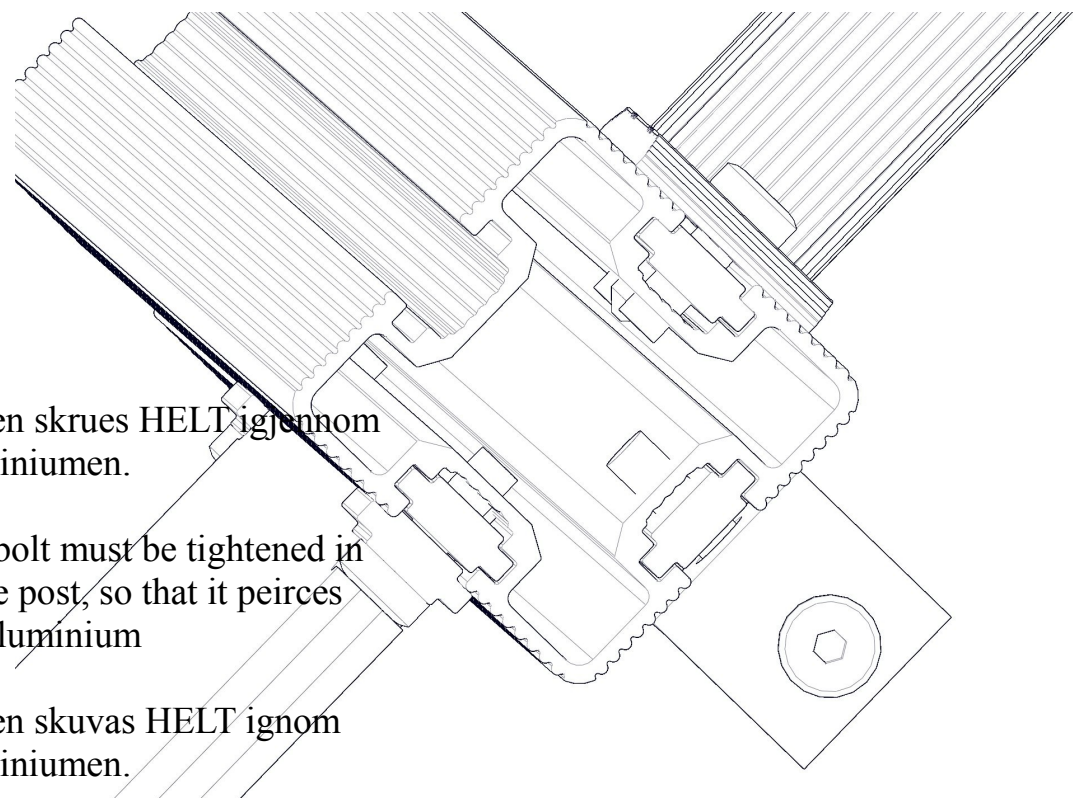

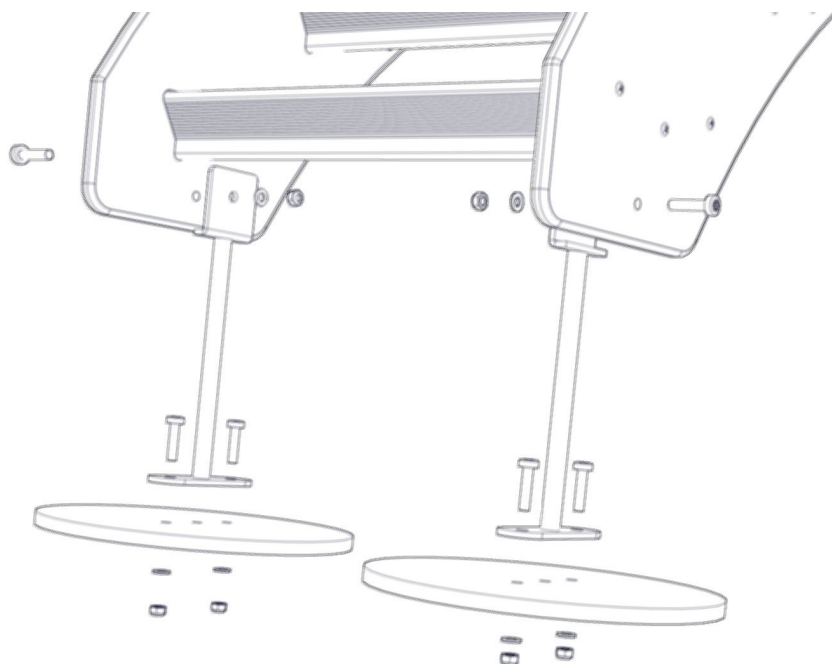

BOM ID	Name	SW Configuration	Artnr (config)	Qty
1	Fundament_platte_2H-1	Hoh80	00-003-106	2
2	Steun-1	liten	00-100-310	2
3	TorxM8-	TXM8x35	04-000-035	6
4	mutter_M8-	M8_Borg	04-040-008	6
5	Skive-	M8	04-050-008	6

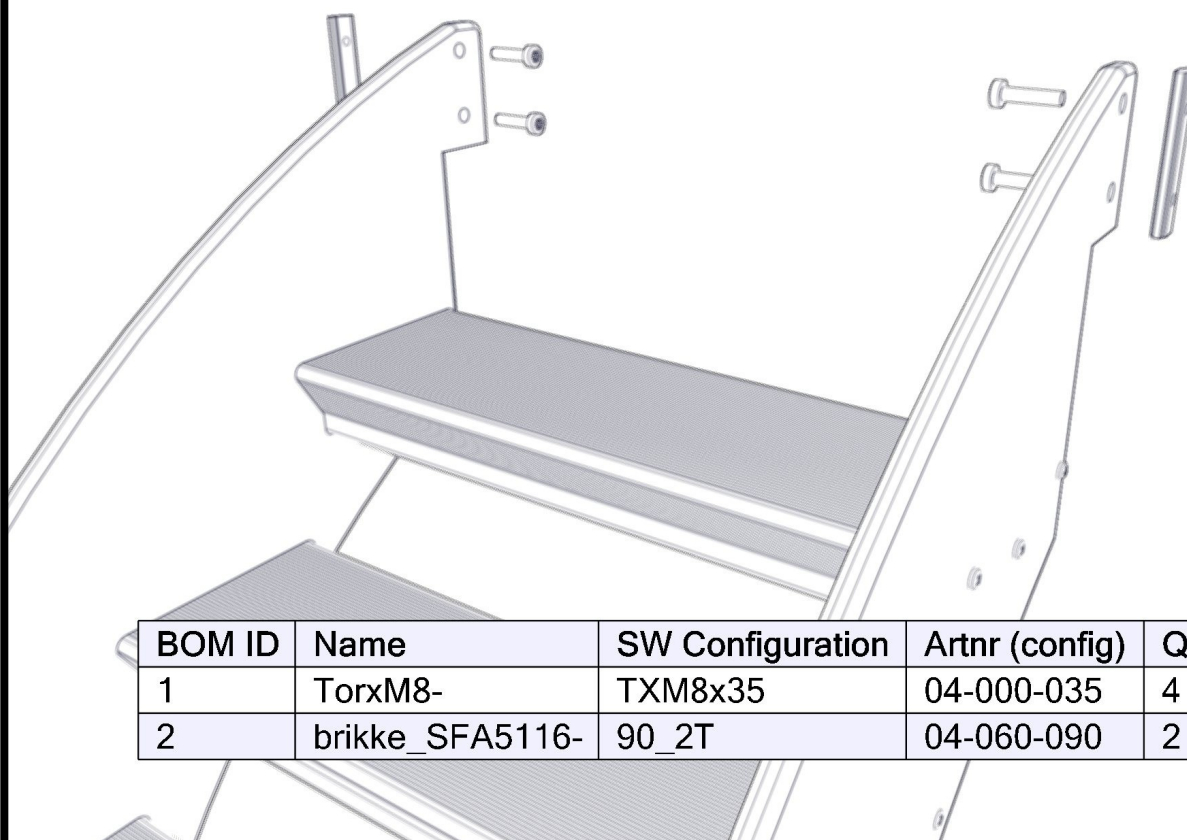

BOM ID	Name	SW Configuration	Artnr (config)	Qty
1	TorxM8-	TXM8x35	04-000-035	4
2	brikke_SFA5116-	90_2T	04-060-090	2

### Før utstyret tas i bruk / Before play begins / Innan lekredskapet tas i bruk

N

- Påse at fallunderlag er utlagt i henhold til gjeldende regler eller vår anbefaling
- Fjern alle monteringshjelpemidler ( rester av betong, planker, paller, plast, og lignende)
- Før utstyret tas i bruk, burde man sjekke at det ikke er fare for at anorakksnorer og lignende som kan hekte seg fast noen steder på lekeapparatet. (Vedlagte snor med dobbe (kneledd) kan brukes til å sjekke at dette er i orden. Se vedlagte veiledning for bruk av denne. Dette gjøres for å oppdage eventuelle feilmonteringer.?)
- NB! Bør stå i 2-3 dager før bruk

UK

- Make sure the area and depth of safer surfacing are according to the current standard, or to the manufacturer's recommendation
- Make sure all tools and surplus materials are removed before play begins
- PS! When complete, allow 2-3 days for the concrete to set before use







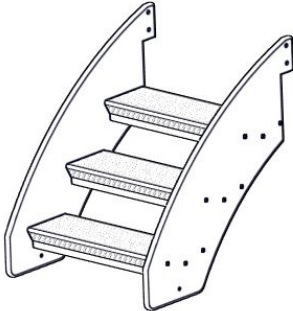

S

- Kontrollera att fallunderlag är utlagt enligt gällande regler eller vårt rekomenation
- Ta bort alla monteringshjälpmedel (rester av betong, plankor, pallar, plast och liknande)
- Innan lekredskapet används, kontrollera att anoracksnoddar eller kläder/delar av kläder eller liknande inte kan fastna i några delar på redskapet. (Den bipackade "knävringen" kan man med fördel användas för denna kontroll.
- Detta görs för att upptäcka eventuella felmonteringar.)



**Boltepakker for / Boltpackage for / Bultpaket för**

Sign. \_\_\_\_\_

Trapp 950	Ant= 1	Navn	Artnr/dimensjon	Ant	Lev
		Trapp 550	01-290-090	1	
		Steun liten (2)	00-100-310	2	
		Brikke 90 2T (2)	04-060-090	2	
		Torx M8x35(4)	04-000-035	10	
		Fundament plate (2)	00-003-106	2	
		Skive M8	04-050-008	6	
		Mutter M8	04-040-008	6	