

**Monteringsanvisning****Assembly Instructions****Monteringsanvisning**

Produkt nr. / Product no. / Produkt nr.

01-400-450K**Sort / Gul / Rød**

Ord. nr. _____

Dato. _____

Sign. _____

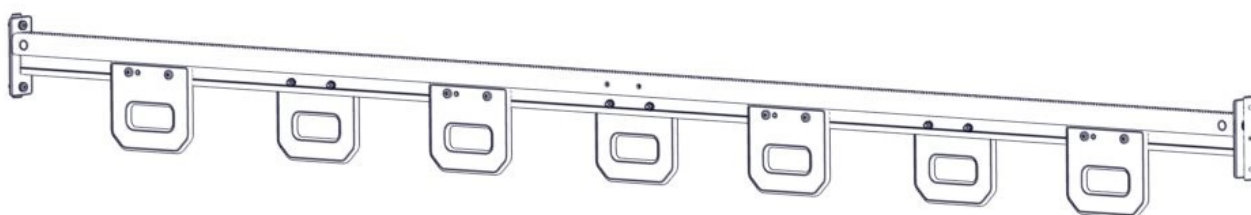
**søve**



Søve AS
Grønnvoldveien 290
3830 Ulefoss - Norway
Tlf: +47 35 94 65 65
www.sove.no

**søve**

Søve AB
EA Rosengrensgatan 32
421 31 Västra Frölunda
Phone: +46 (0)31 773 97 00
www.sove.se

Boltepakker for / Boltpackage for / Bultpaket för

Sign. _____.

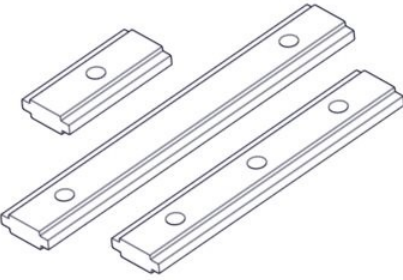
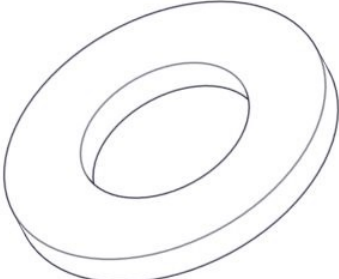
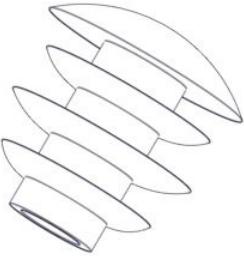
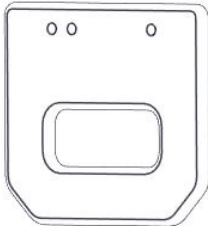
Drager 8-kant handtak Sort komplett 01-400-450K	Navn	Artnr/dimensjon	Ant	Lev
	Drager til 8-kant med hull for handtak Sort	01-400-450	1	
	Torx M8x30 Torx M8x35	04-000-030 04-000-035	4 14	
	Brikke 160 3xM8	04-060-160	2	
	Skive M8	04-050-008	18	
	Plastpropp 9-11mm	04-090-002	7	
	Handtak Rød Handtak Gul	00-400-177 00-400-176	3 4	

Boltepakker for / Boltpackage for / Bultpaket för

Sign. _____.

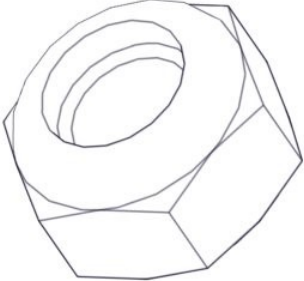
Drager 8-kant handtak Sort komplett 01-400-450K	Navn	Artnr/dimensjon	Ant	Lev
	Låsemutter M8	04-040-008	14	

Montering av lekeapparatet / Assembly instructions / Montering av lekredskapet

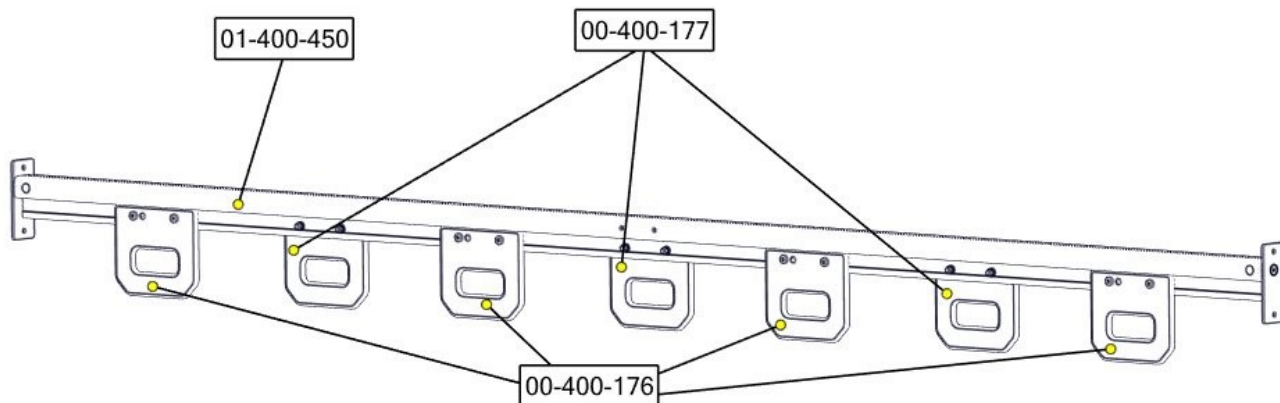

Part Name	Article nr.	Qty
Torx M8x35	04-000-035	14
Skive M8	04-050-008	14
Plastpropp 13mm hode / dekker 9-11 mm hull	04-090-002	7
Låsemutter M8	04-040-008	14

Part Name	Article nr.	Qty
Håndtak HPL	00-400-177	3
Håndtak HPL	00-400-176	4
Drager L=3080 for 7 handtak	01-400-450	1

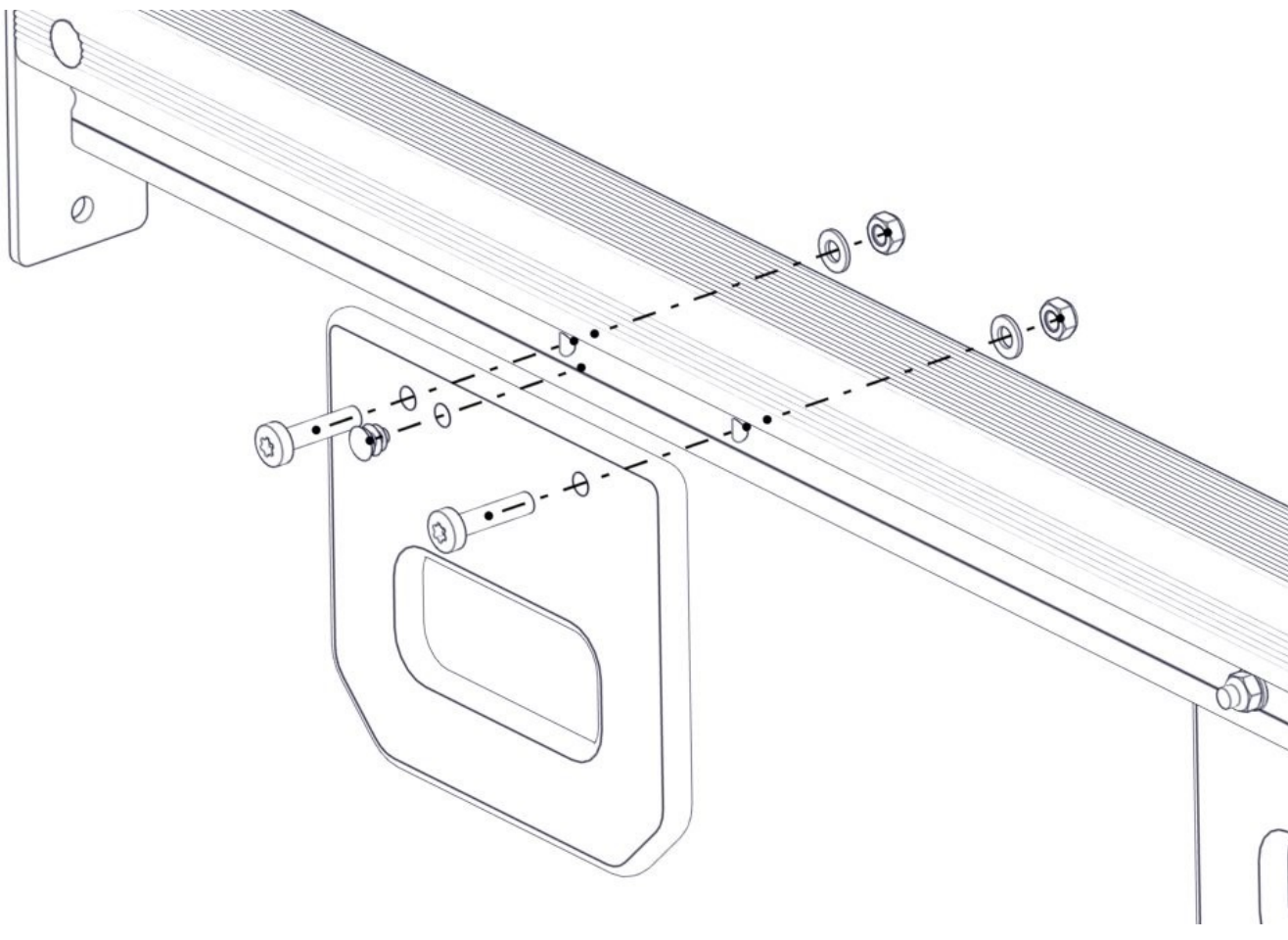

Montering av lekeapparatet / Assembly instructions / Montering av lekredskapet

Se på hovedmontering for posisjon
 Look at main assembly for position
 Titta på hovudmontering för position

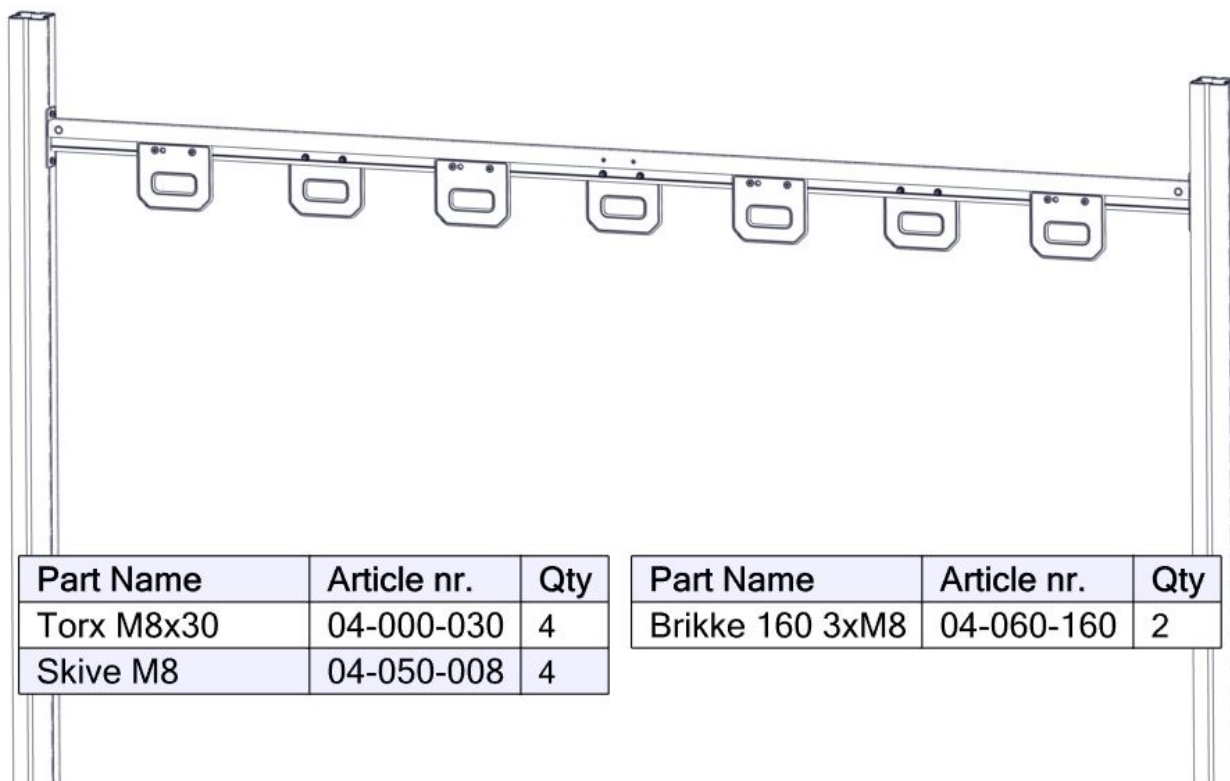

Part Name	Article nr.	Qty
Torx M8x30	04-000-030	4
Skive M8	04-050-008	4

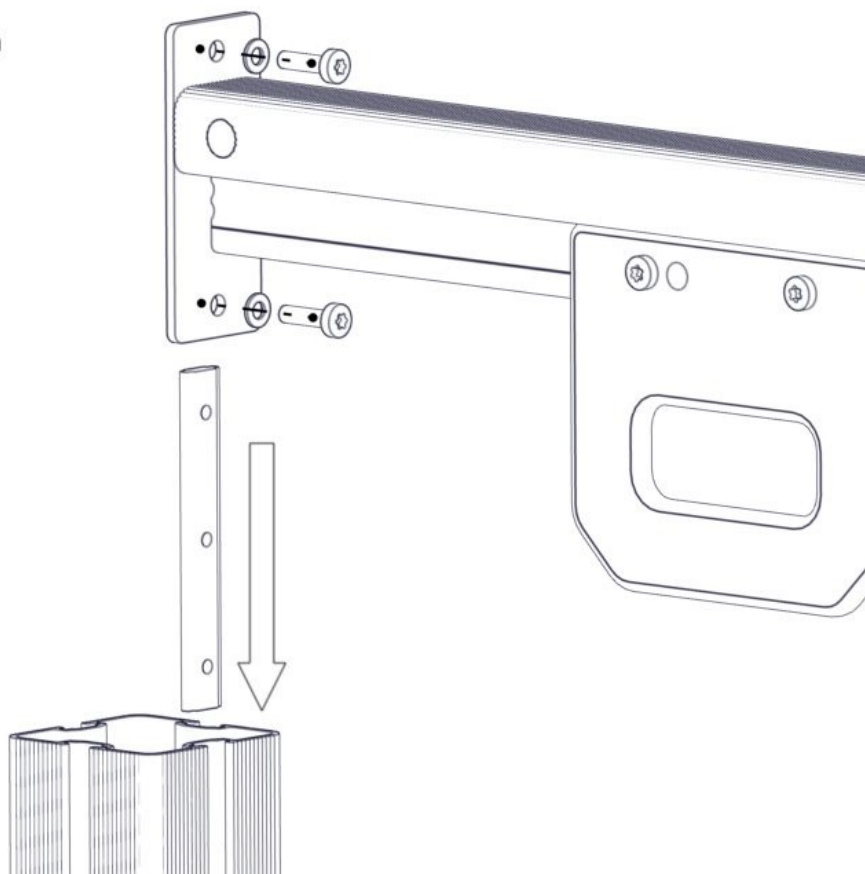

Part Name	Article nr.	Qty
Brikke 160 3xM8	04-060-160	2

Se på hovedmontering for posisjon
 Look at main assembly for position
 Titta på hovudmontering för position



Boltepakker for / Boltpackage for / Bultpaket för

Sign. _____.

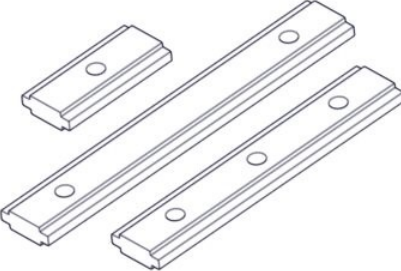
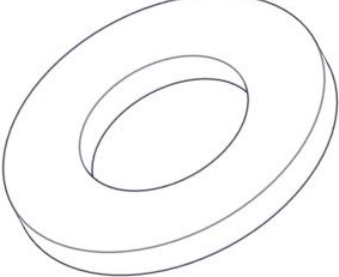
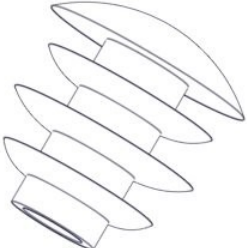
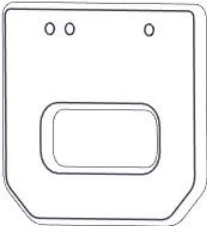
Drager 8-kant handtak Sort komplett 01-400-450K	Navn	Artnr/dimensjon	Ant	Lev
	Drager til 8-kant med hull for handtak Sort	01-400-450	1	
	Torx M8x30 Torx M8x35	04-000-030 04-000-035	4 14	
	Brikke 160 3xM8	04-060-160	2	
	Skive M8	04-050-008	18	
	Plastpropp 9-11mm	04-090-002	7	
	Handtak Rød Handtak Gul	00-400-177 00-400-176	3 4	

Boltepakker for / Boltpackage for / Bultpaket för

Sign. _____.

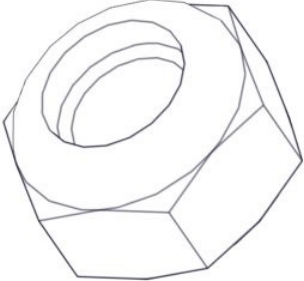
Drager 8-kant handtak Sort komplett 01-400-450K	Navn	Artnr/dimensjon	Ant	Lev
	Låsemutter M8	04-040-008	14	