

N**Monteringsanvisning****EN****Assembly Instructions****S****Monteringsanvisning**

Produkt nr. / Product no. / Produkt nr.

02-500-068K

Ord. nr. _____

Dato. _____

Sign. _____







Søve AS
Grønnvoldveien 290
3830 Ulefoss - Norway
Tlf: +47 35 94 65 65
www.sove.no

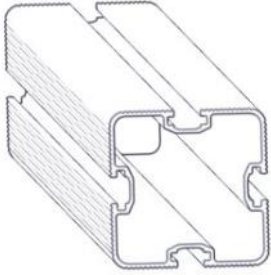
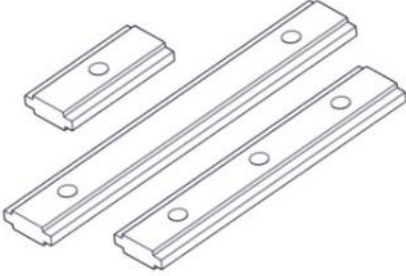

Søve AB
EA Rosengrensgatan 32
421 31 Västra Frölunda
Phone: +46 (0)31 773 97 00
www.sove.se

Boltepakker for / Boltpackage for / Bultpaket för

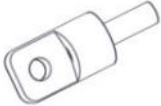
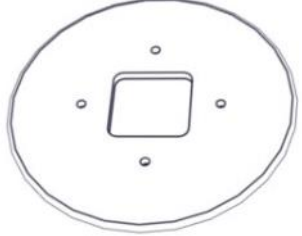
Sign. _____

Skute mast 02-500-068K	Navn	Artnr/dimensjon	Ant	Lev
	Stolpe 95x95 600-2300 L=2900 Sort	SFA5117/1	1	
	Brikke 50 1xM8	04-060-050	12	
	Torx M8x12 Torx M8x25 Torx M8x30	04-000-012 04-000-025 04-000-030	4 4 2	
	Dekkhylse Ø20x35 Med gjengestang M8x35	04-088-006	2	
	Plate rund stolpe Blå	02-500-080	1	
	Flagg skute	02-500-067	1	

Boltepakker for / Boltpackage for / Bultpaket för

Sign. _____

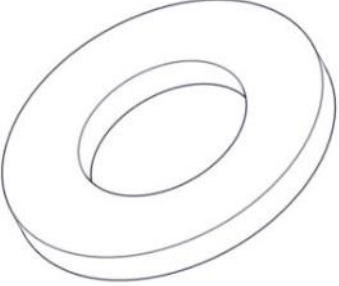
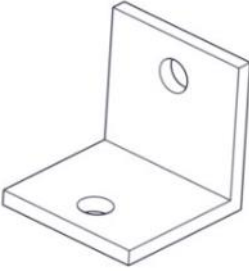
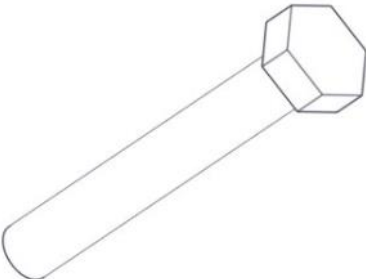
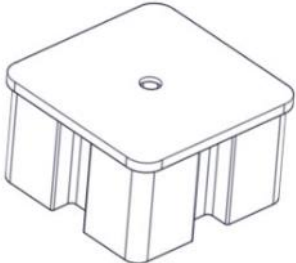
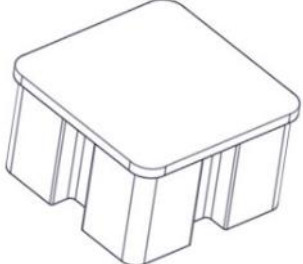
Skute mast 02-500-068K	Navn	Artnr/dimensjon	Ant	Lev
	Møbelknapp M8x11	04-030-011	4	
	Skive M8 Skive M8 stor	04-050-008 04-055-008	4 2	
	Vinkel 50x50x50x5 11mm hull	04-070-050	4	
	Sekskant M8x70	04-008-070	4	
	Endelokk 95x95 Med hull	00-400-997	1	
	Endelokk 95x95	00-400-998	1	

Fundamentering med betong / Foundation concrete / Förankring med betong

- (N) Støtdempende materialer Ref NS-EN 1176-1
- (EN) Impact attenuating materials §4.2.8.5
- (S) Støtdämpande material



- (N) Bakkenivå
- (EN) Ground level
- (S) marknivå

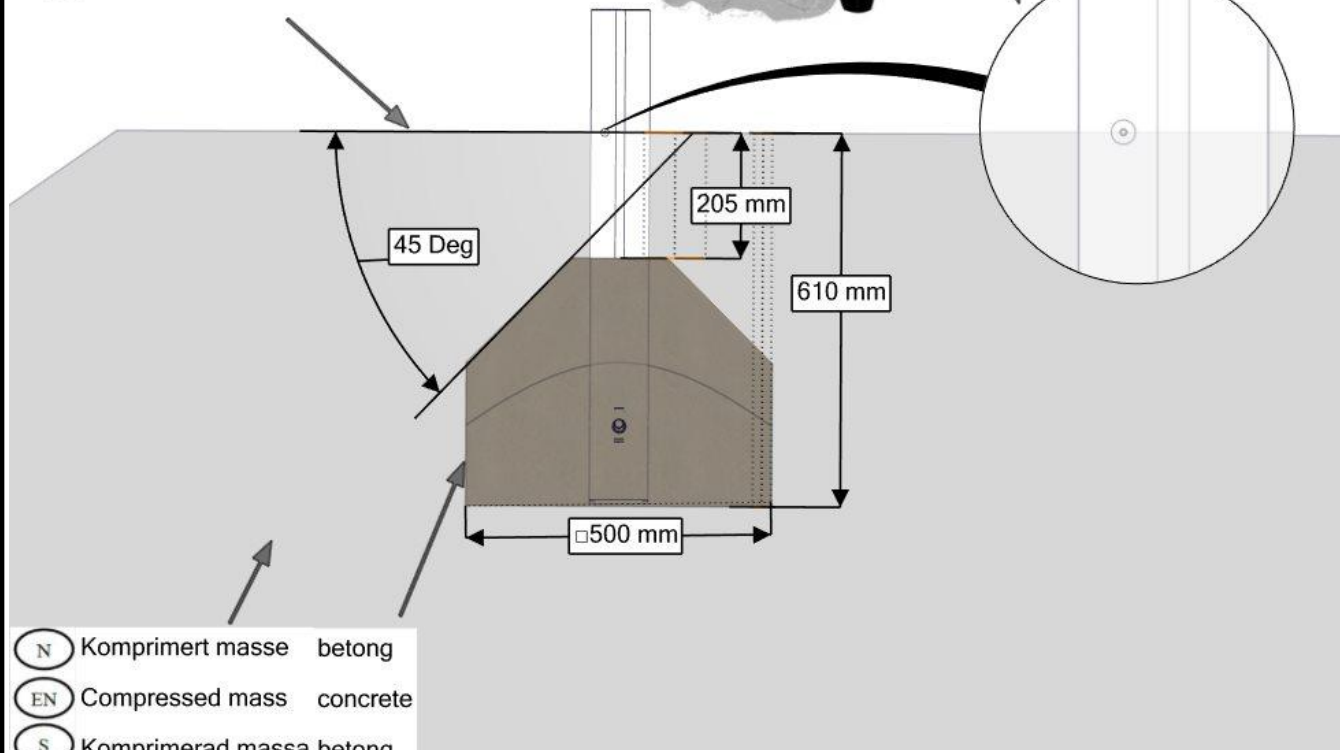

- (N) Komprimert masse betong
- (EN) Compressed mass concrete
- (S) Komprimerad massa betong

Montering av lekeapparatet / Assembly instructions / Montering av lekredskapet

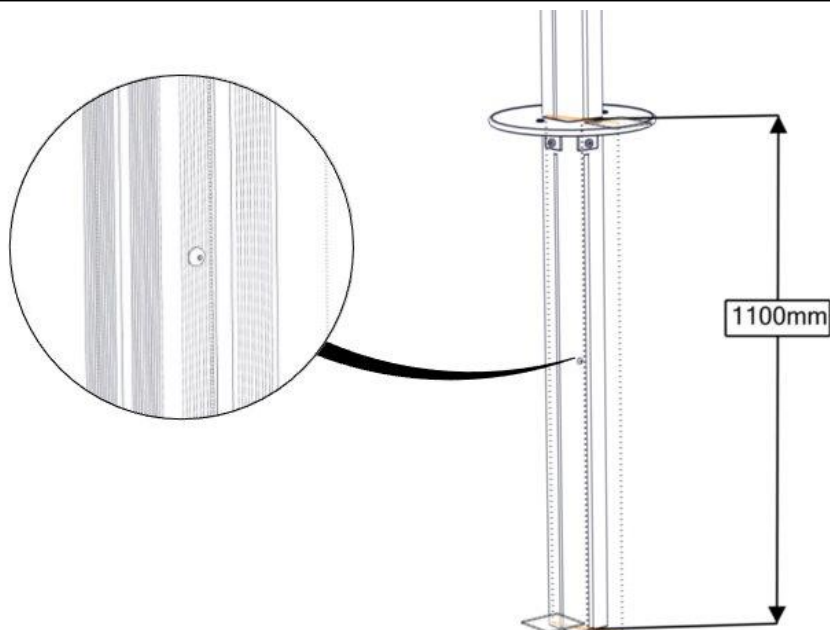

Part Name	Article nr.	Qty
Plate rund 95x95 stolpe	02-500-080	1
Torx M8x12	04-000-012	4
Torx M8x25	04-000-025	4
Møbelknapp M8x11	04-030-011	4
Skive M8	04-050-008	4

Part Name	Article nr.	Qty
Brikke 50 1XM8	04-060-050	4
Vinkel 50x50x50x5 11mm hull	04-070-050	4
Stolpe 95x95 L=2900	SFA5117/1	1

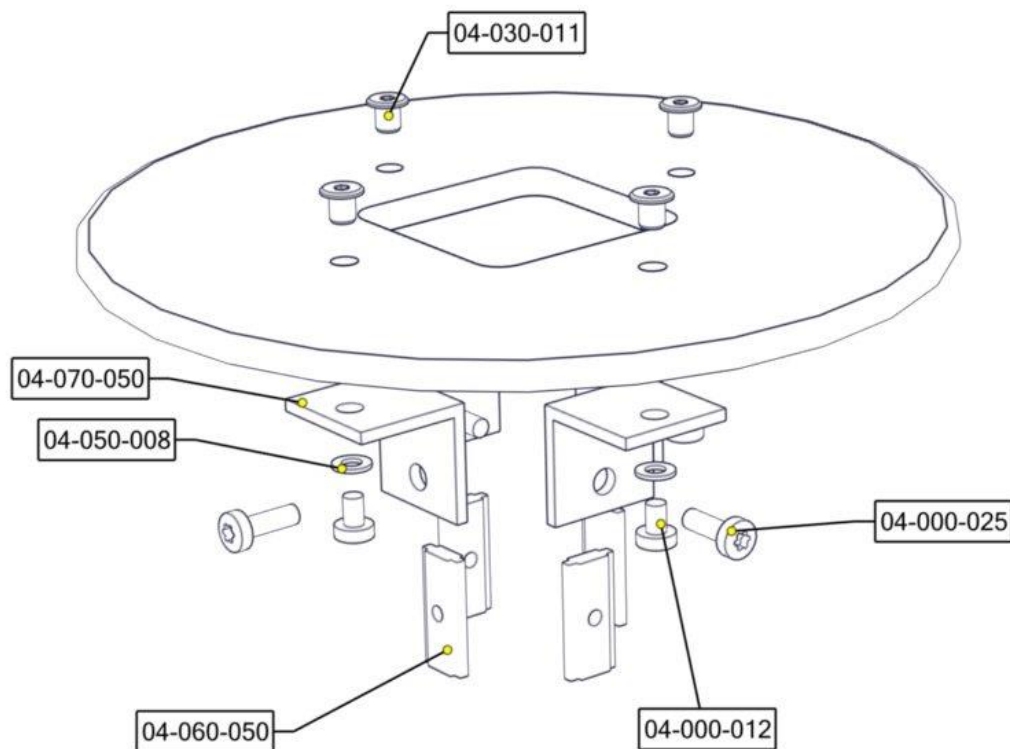

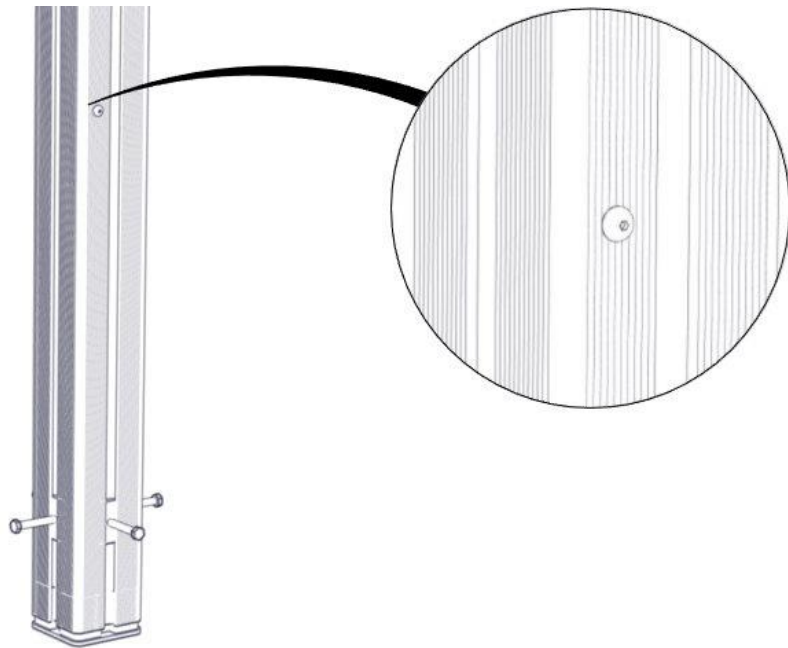
Montering av lekeapparatet / Assembly instructions / Montering av lekredskapet

Part Name	Article nr.	Qty
Endelokk 95x95 med hull	00-400-997	1
Sekskant M8x70	04-008-070	4
Brikke 50 1XM8	04-060-050	4

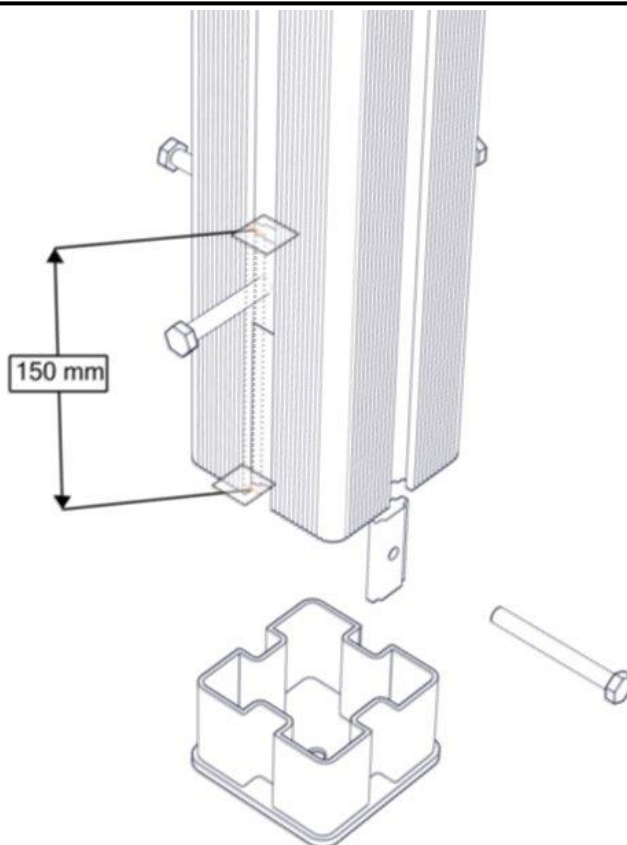

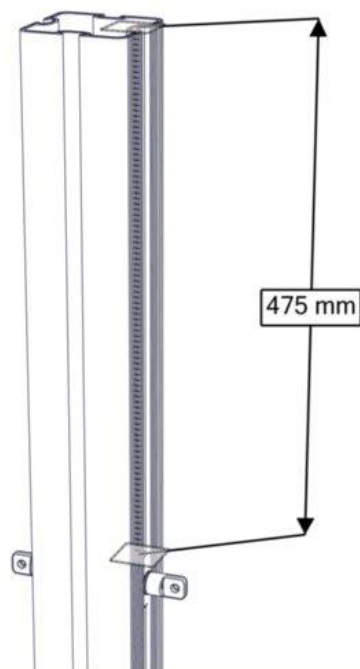
Montering av lekeapparatet / Assembly instructions / Montering av lekredskapet

Part Name	Article nr.	Qty
Skive M8 stor	04-055-008	2
Brikke 50 1XM8	04-060-050	2
Dekkhylse Ø20x35 med gjenestang M8x35	04-088-006	2

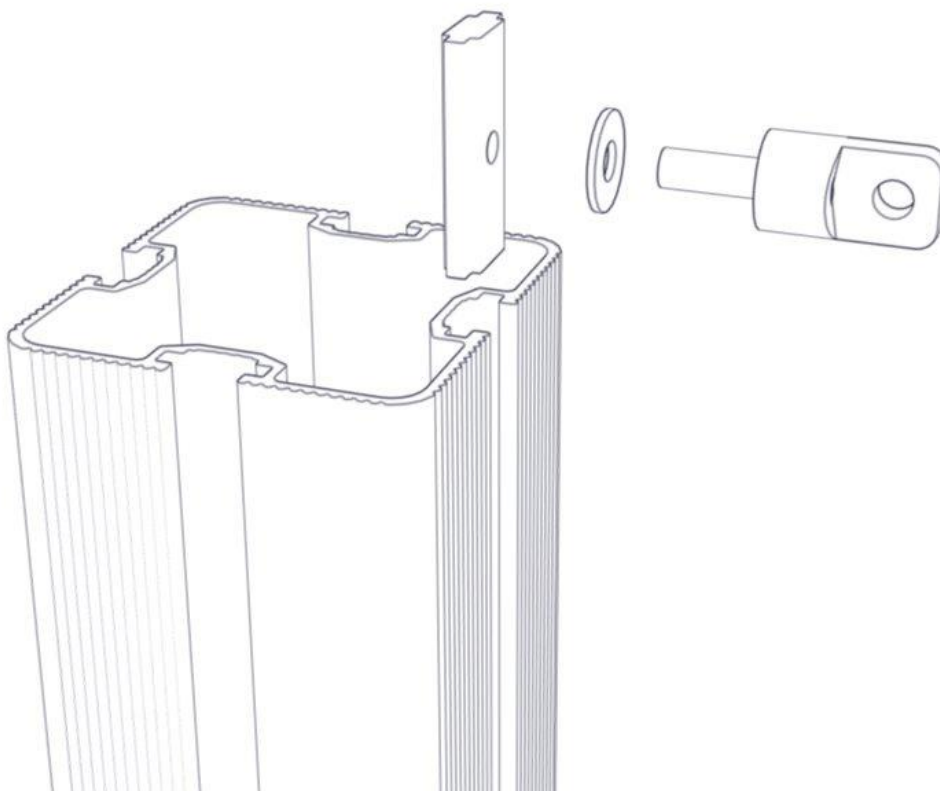

Montering av lekeapparatet / Assembly instructions / Montering av lekredskapet

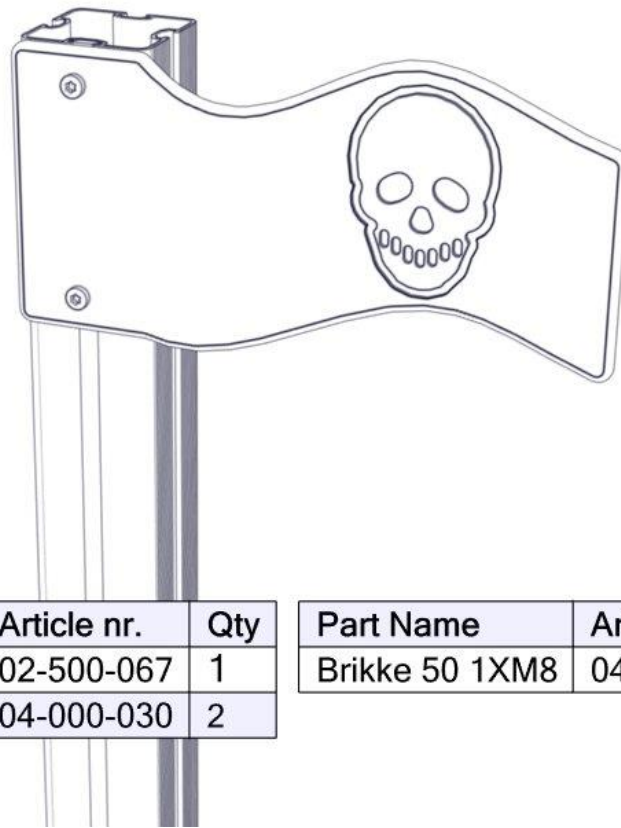

Part Name	Article nr.	Qty
Flagg Skute	02-500-067	1
Torx M8x30	04-000-030	2



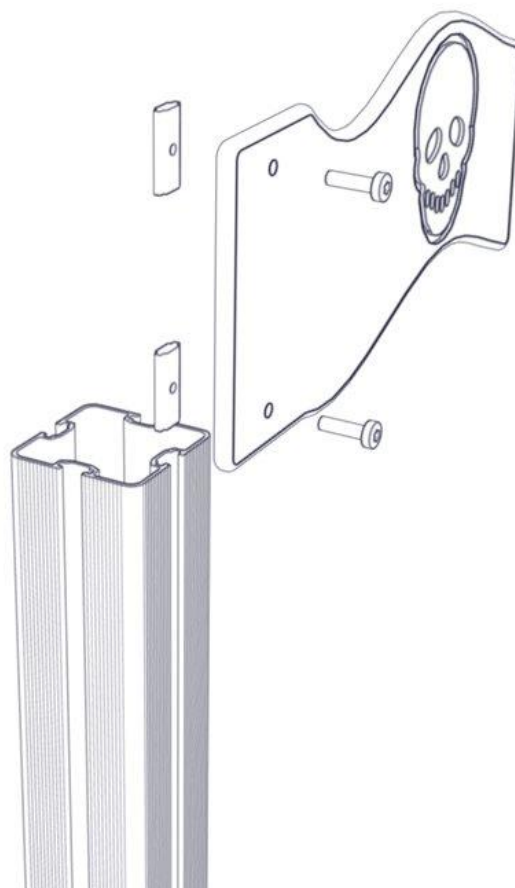

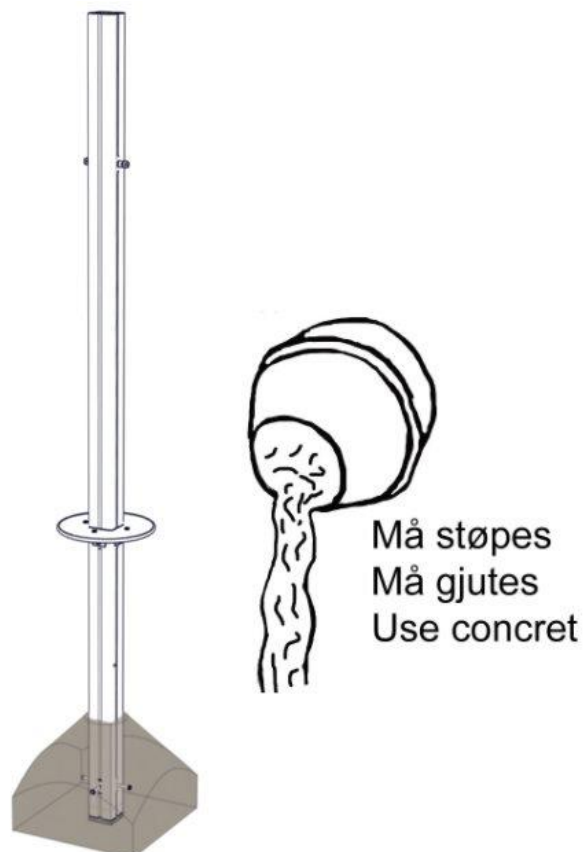
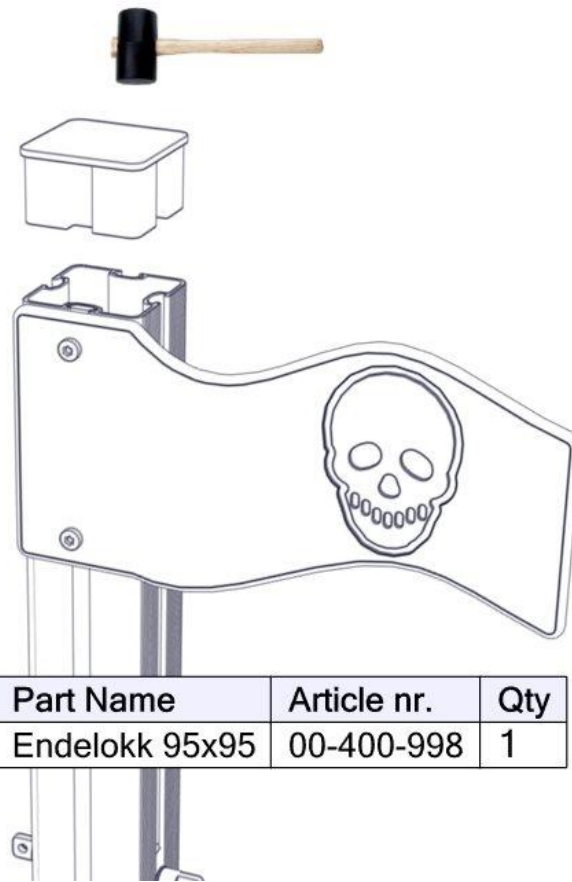
Part Name	Article nr.	Qty
Brikke 50 1XM8	04-060-050	2

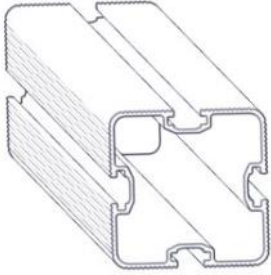
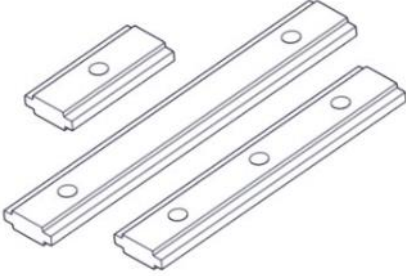

Montering av lekeapparatet / Assembly instructions / Montering av lekredskapet

Boltepakker for / Boltpackage for / Bultpaket för

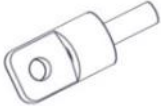
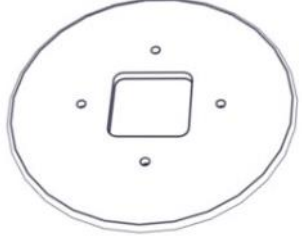
Sign. _____

Skute mast 02-500-068K	Navn	Artnr/dimensjon	Ant	Lev
	Stolpe 95x95 600-2300 L=2900 Sort	SFA5117/1	1	
	Brikke 50 1xM8	04-060-050	12	
	Torx M8x12 Torx M8x25 Torx M8x30	04-000-012 04-000-025 04-000-030	4 4 2	
	Dekkhylse Ø20x35 Med gjengestang M8x35	04-088-006	2	
	Plate rund stolpe Blå	02-500-080	1	
	Flagg skute	02-500-067	1	

Boltepakker for / Boltpackage for / Bultpaket för

Sign. _____

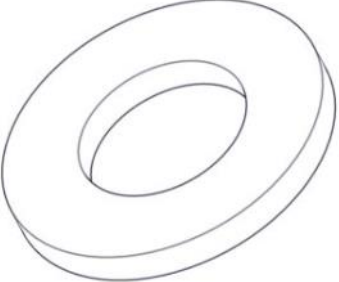
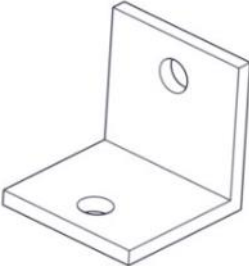
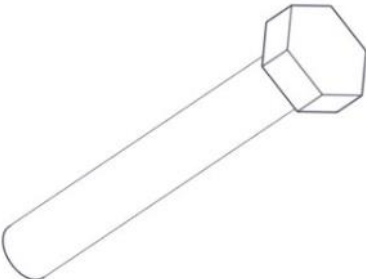
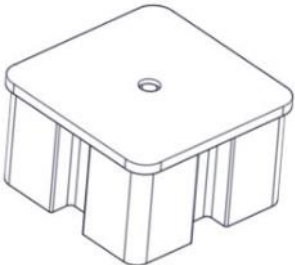
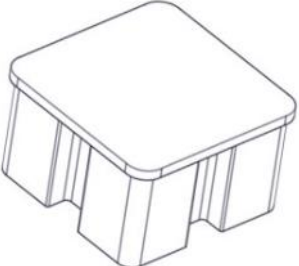
Skute mast 02-500-068K	Navn	Artnr/dimensjon	Ant	Lev
	Møbelknapp M8x11	04-030-011	4	
	Skive M8 Skive M8 stor	04-050-008 04-055-008	4 2	
	Vinkel 50x50x50x5 11mm hull	04-070-050	4	
	Sekskant M8x70	04-008-070	4	
	Endelokk 95x95 Med hull	00-400-997	1	
	Endelokk 95x95	00-400-998	1	