

**N****Monteringsanvisning****EN****Assembly Instructions****S****Monteringsanvisning**

Produkt nr. / Product no. / Produkt nr.

**02-500-097K****Blå**

Ord. nr. \_\_\_\_\_

Dato. \_\_\_\_\_



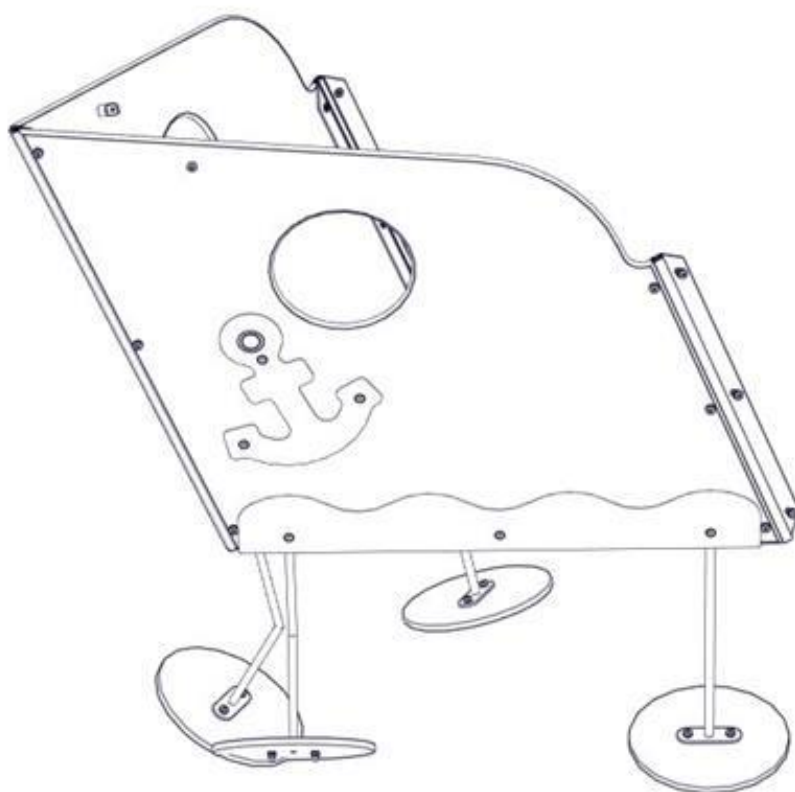

Sign. \_\_\_\_\_





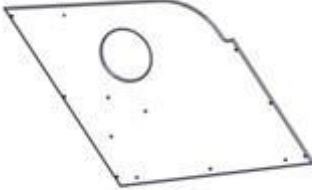

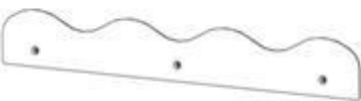

Søve AS  
Grønnvoldveien 290  
3830 Ulefoss - Norway  
Tlf: +47 35 94 65 65  
[www.sove.no](http://www.sove.no)

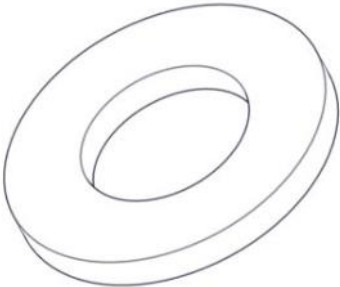

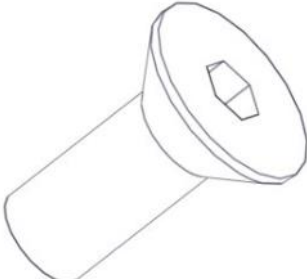

Søve AB  
EA Rosengrensgatan 32  
421 31 Västra Frölunda  
Phone: +46 (0)31 773 97 00  
[www.sove.se](http://www.sove.se)

<b>Boltepakker for / Boltpackage for / Bultpaket för</b>		Sign. _____.		
<b>Skute Baug 02-500-097K</b>	<b>Navn</b>	<b>Artnr/dimensjon</b>	<b>Ant</b>	<b>Lev</b>
	Sjørøverskute, Styrhus Sidevegg. Blå	02-500-097	2	
	Sjørøverskute, hengsel front	02-500-096	1	
	Sjørøverskute, hengsel Side	02-500-095	2	
	Torx M8x12	04-000-012	18	
	Torx M8x20	04-000-020	2	
	Møbelknapp M8x11	04-030-011	18	
	Bolger kort m/ forsenket hull	02-500-076	2	

<b>Boltepakker for / Boltpackage for / Bultpaket för</b>		Sign. _____		
<b>Skute Baug 02-500-097K</b>	<b>Navn</b>	<b>Artnr/dimensjon</b>	<b>Ant</b>	<b>Lev</b>
	Skive M8	04-050-008	18	
	Skive M8 Stor	04-055-008	12	
	Anker med forsenking	02-500-070	2	
	Umbrako med senkhode M8x35	04-034-035	8	
	M8x40	04-034-040	4	
	M8 Låsemutter	04-040-008	12	
	Endedeksel flatt M10/M12 sort hode	05-301-035	12	
	Endedeksel flatt M10/M12 sort kropp	05-301-035	12	



**Boltepakker for / Boltpackage for / Bultpaket för**

Sign. \_\_\_\_\_.

Skute Baug 02-500-097K	Navn	Artnr/dimensjon	Ant	Lev
	Stålforankring L=600 m/ knekk	00-100-311	2	
	Stålforankring L=600	00-100-316	2	
	Dekkhylse Ø20x35 M8x14	04-088-005	2	

**Boltepakker for / Boltpackage for / Bultpaket för**

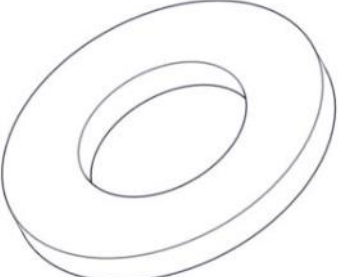
Sign. \_\_\_\_\_

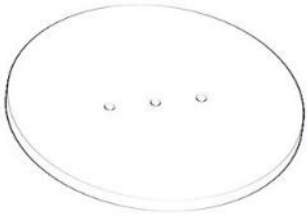
Skute Baug 02-500-097K	Navn	Artnr/dimensjon	Ant	Lev
	<b>Fundament Nedgravning</b>			
	Torx M8x35	04-000-035	8	
	Skive M8	04-050-008	16	
	M8 Låsemutter	04-040-008	8	
	Fundamentplate	00-003-103	4	

## Montering av lekeapparatet / Assembly instructions / Montering av lekredskapet

2x

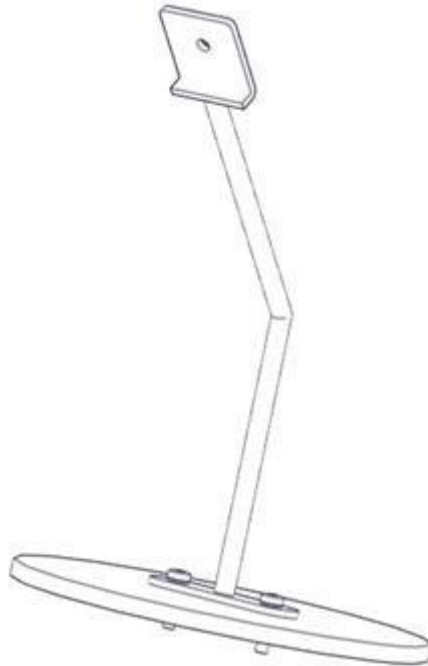

Part Name	Article nr.	Qty
Fundament plate	00-003-103	1
Stålforankring std L=450 m/knekk skute	00-100-311	1
Torx M8x35	04-000-035	2
Låsemutter M8	04-040-008	2
Skive M8	04-050-008	4

2x

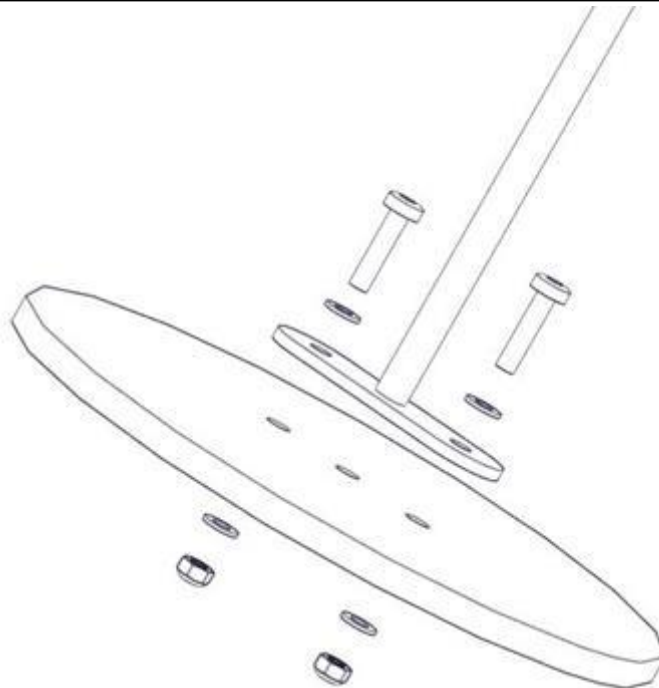

## Montering av lekeapparatet / Assembly instructions / Montering av lekredskapet

2x

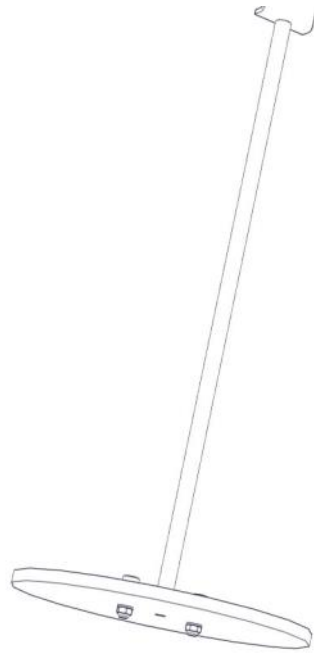

Part Name	Article nr.	Qty
Fundament plate	00-003-103	1
Stålforankring L=600	00-100-316	1
Torx M8x35	04-000-035	2

Part Name	Article nr.	Qty
Låsemutter M8	04-040-008	2
Skive M8	04-050-008	4

2x

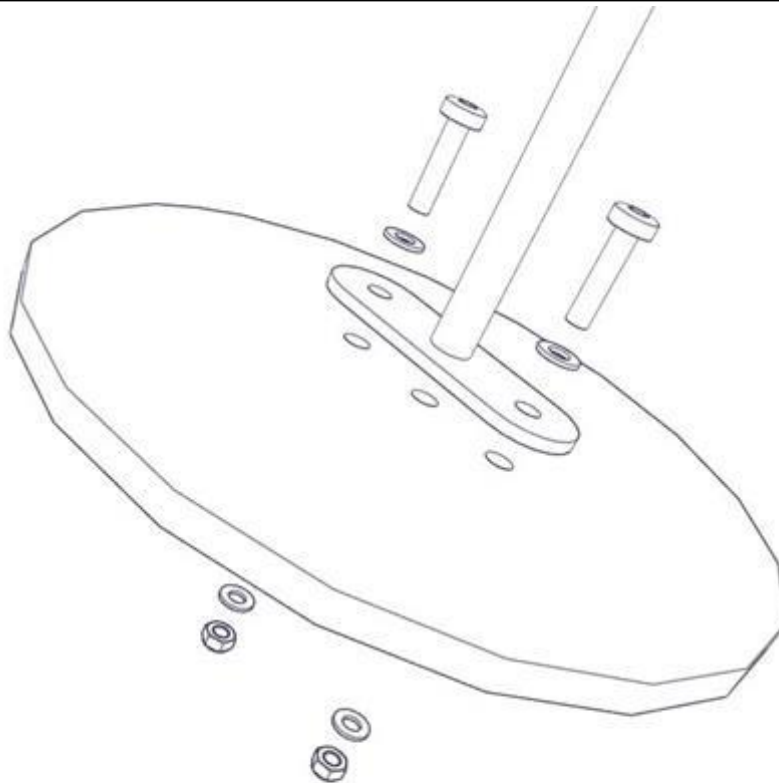

## Montering av lekeapparatet / Assembly instructions / Montering av lekredskapet

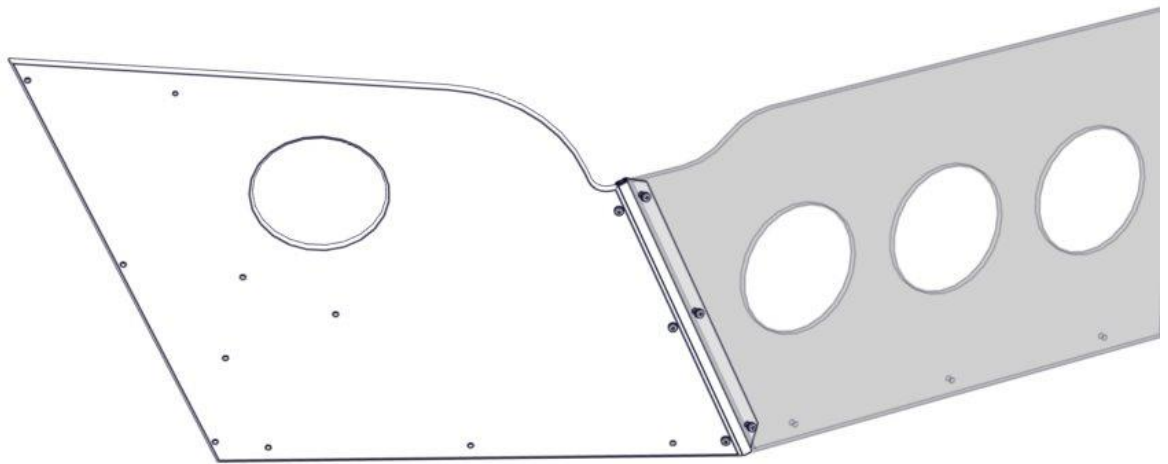

Part Name	Article nr.	Qty
Hengsel Skute Side	02-500-095	1
Sjørøverskute, baugplate	02-500-097	1
Torx M8x12	04-000-012	6

Part Name	Article nr.	Qty
Møbelknapp M8x11	04-030-011	6
Skive M8	04-050-008	6

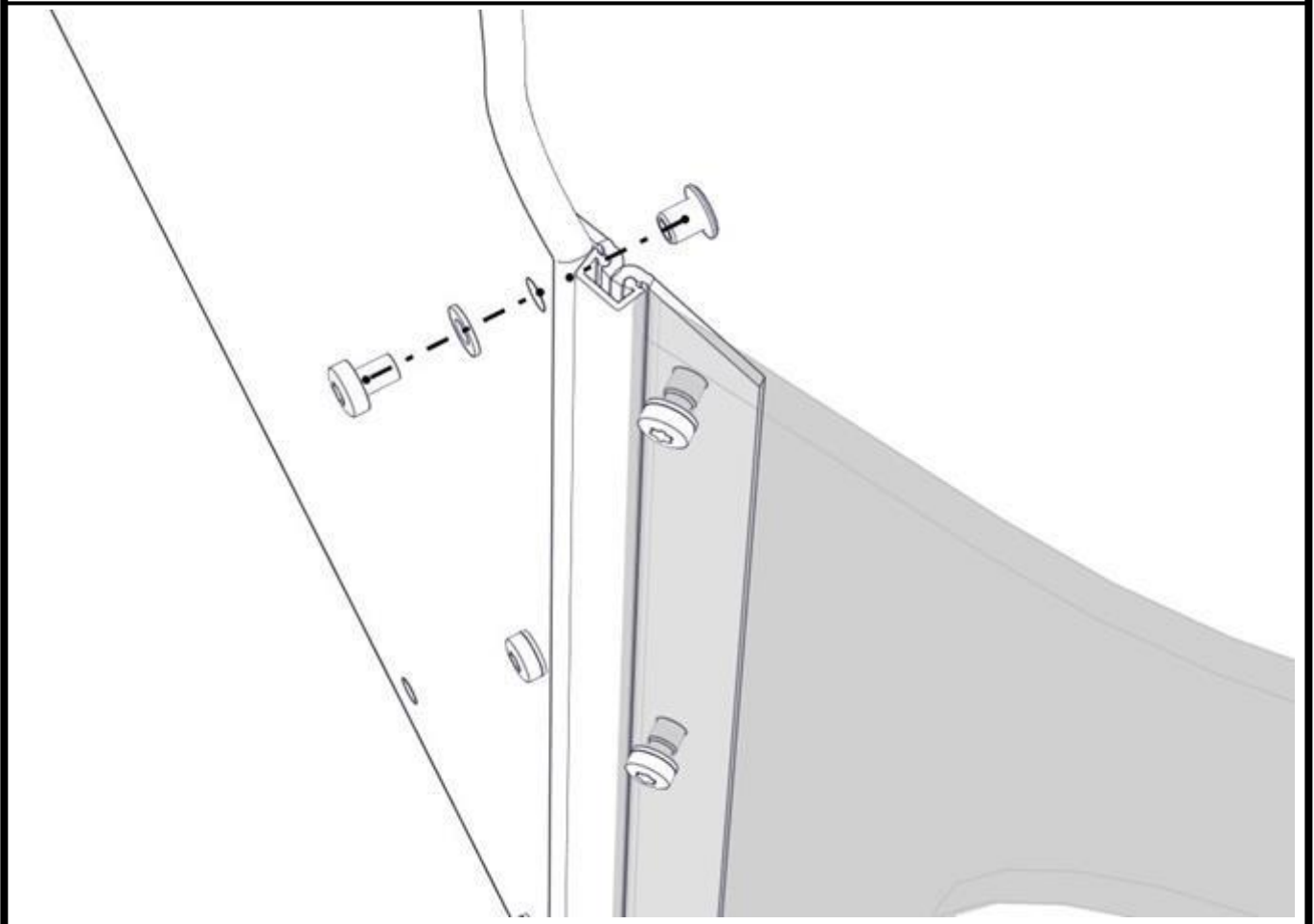



## Montering av lekeapparatet / Assembly instructions / Montering av lekredskapet

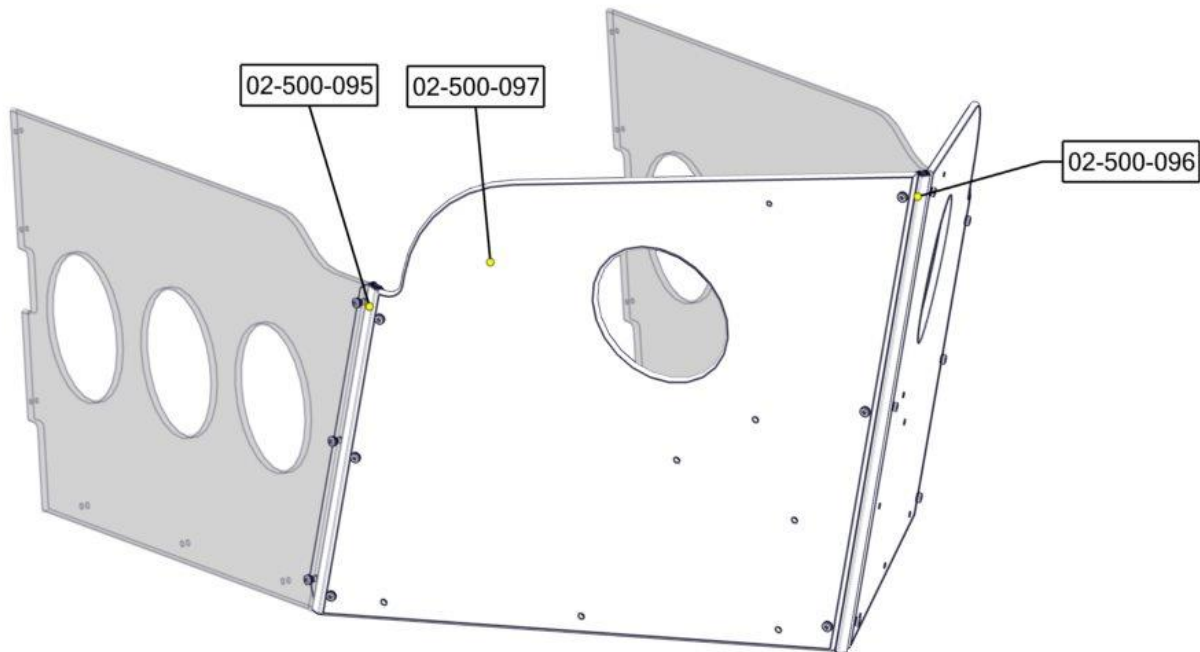

Part Name	Article nr.	Qty
Hengsel Skute Side	02-500-095	1
Hengsel Skute front	02-500-096	1
Sjørøverskute, baugplate	02-500-097	1
Torx M8x12	04-000-012	12

Part Name	Article nr.	Qty
Møbelknapp M8x11	04-030-011	12
Skive M8	04-050-008	12

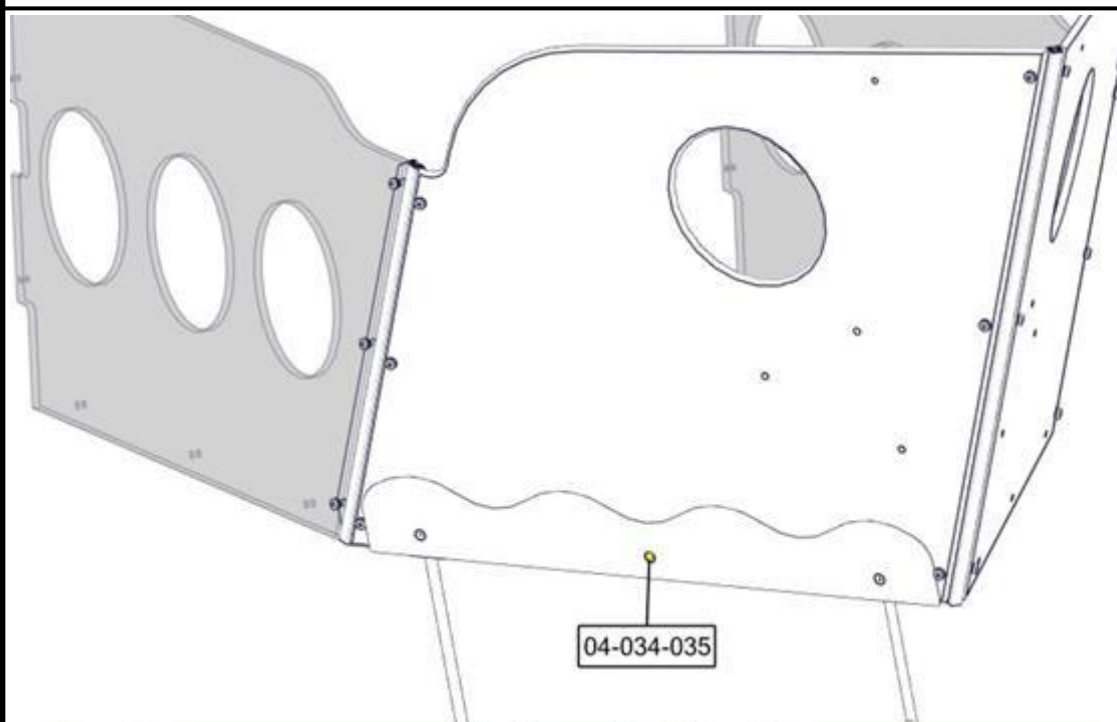

Part Name	Article nr.	Qty
Bolger Kort	02-500-076	1
M8x35_innv6kt_senkhode_syrefast	04-034-035	1
M8x40_innv6kt_senkhode_syrefast	04-034-040	2
Låsemutter M8	04-040-008	3

Part Name	Article nr.	Qty
Skive M8 stor	04-055-008	3
Endedeksel flatt M10/M12 sort hode	05-301-035	3
Endedeksel flatt M10/M12 sort kropp	05-301-035	3

## Montering av lekeapparatet / Assembly instructions / Montering av lekredskapet

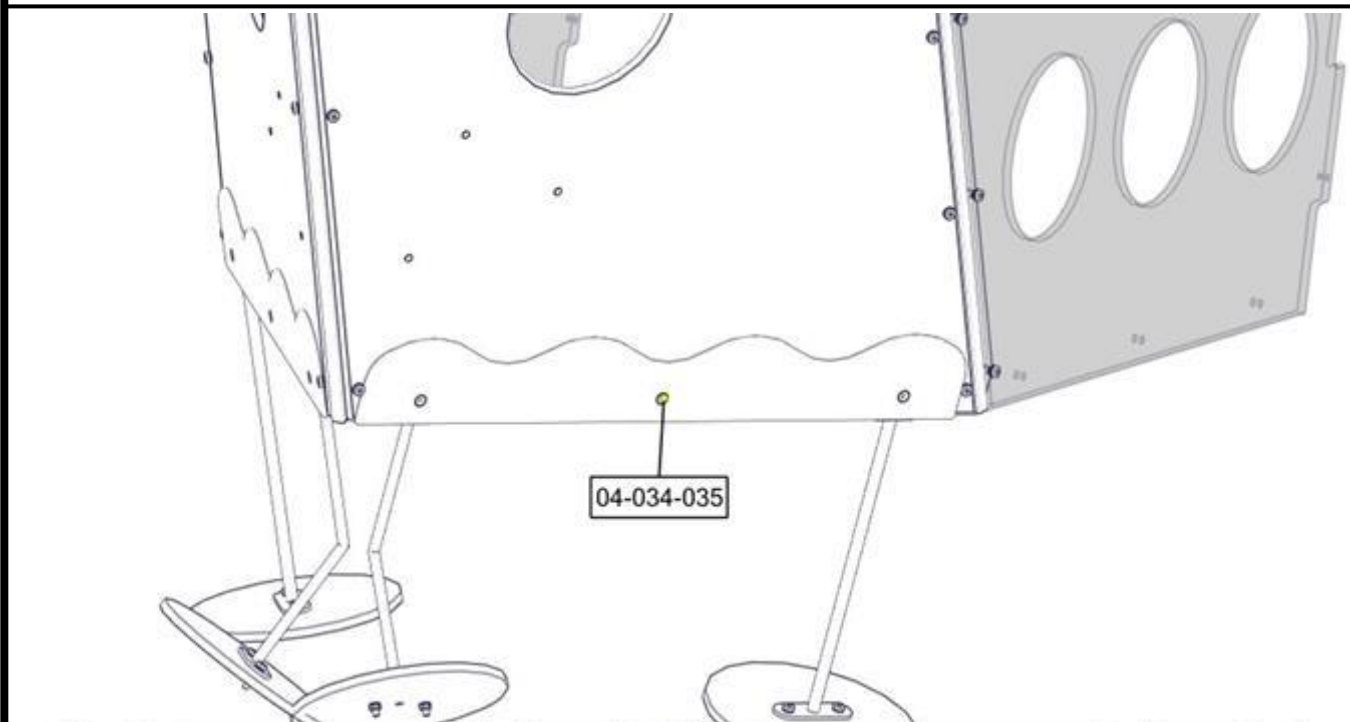
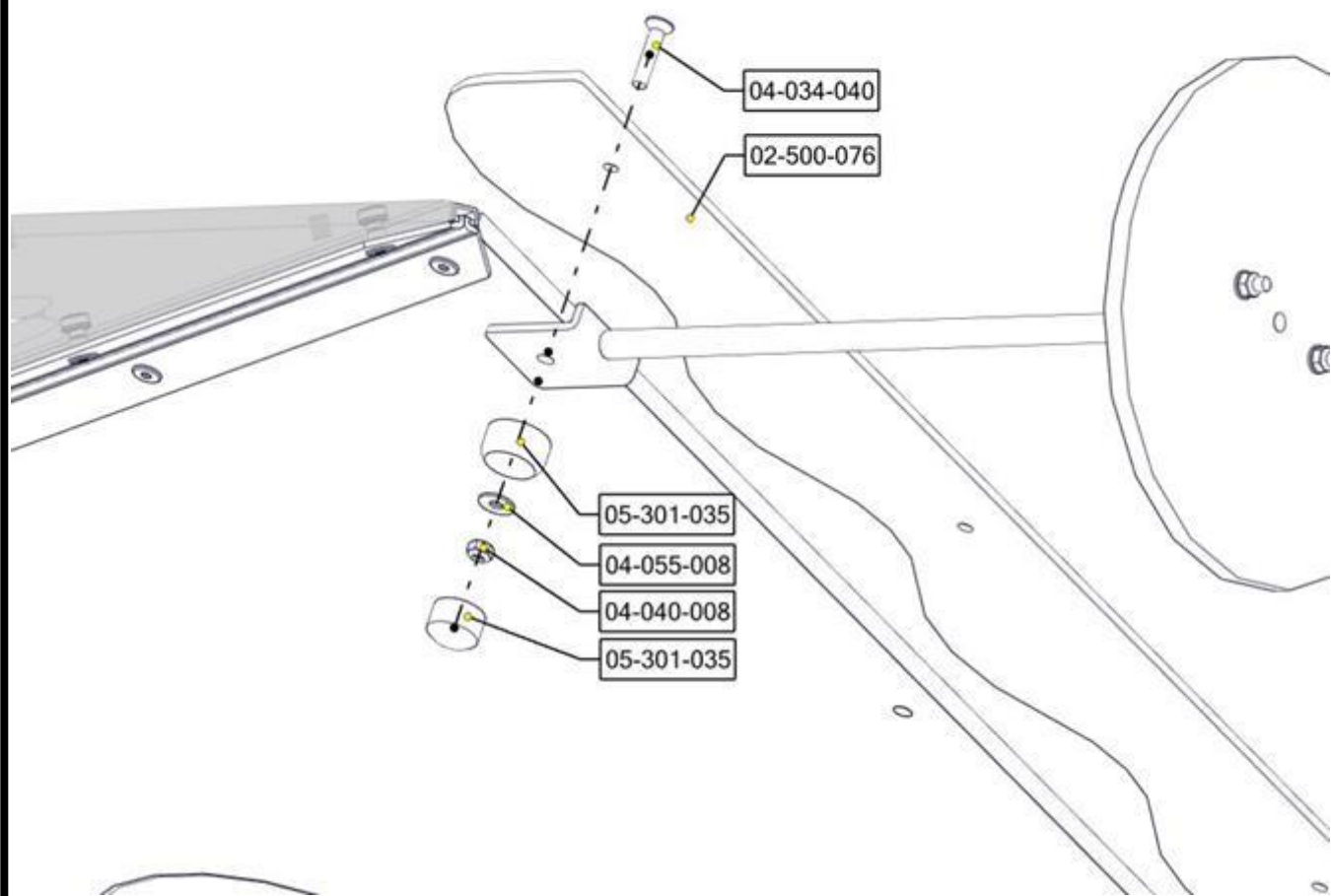

Part Name	Article nr.	Qty
Bolger Kort	02-500-076	1
M8x35_innv6kt_senkhode_syrefast	04-034-035	1
M8x40_innv6kt_senkhode_syrefast	04-034-040	2
Låsemutter M8	04-040-008	3



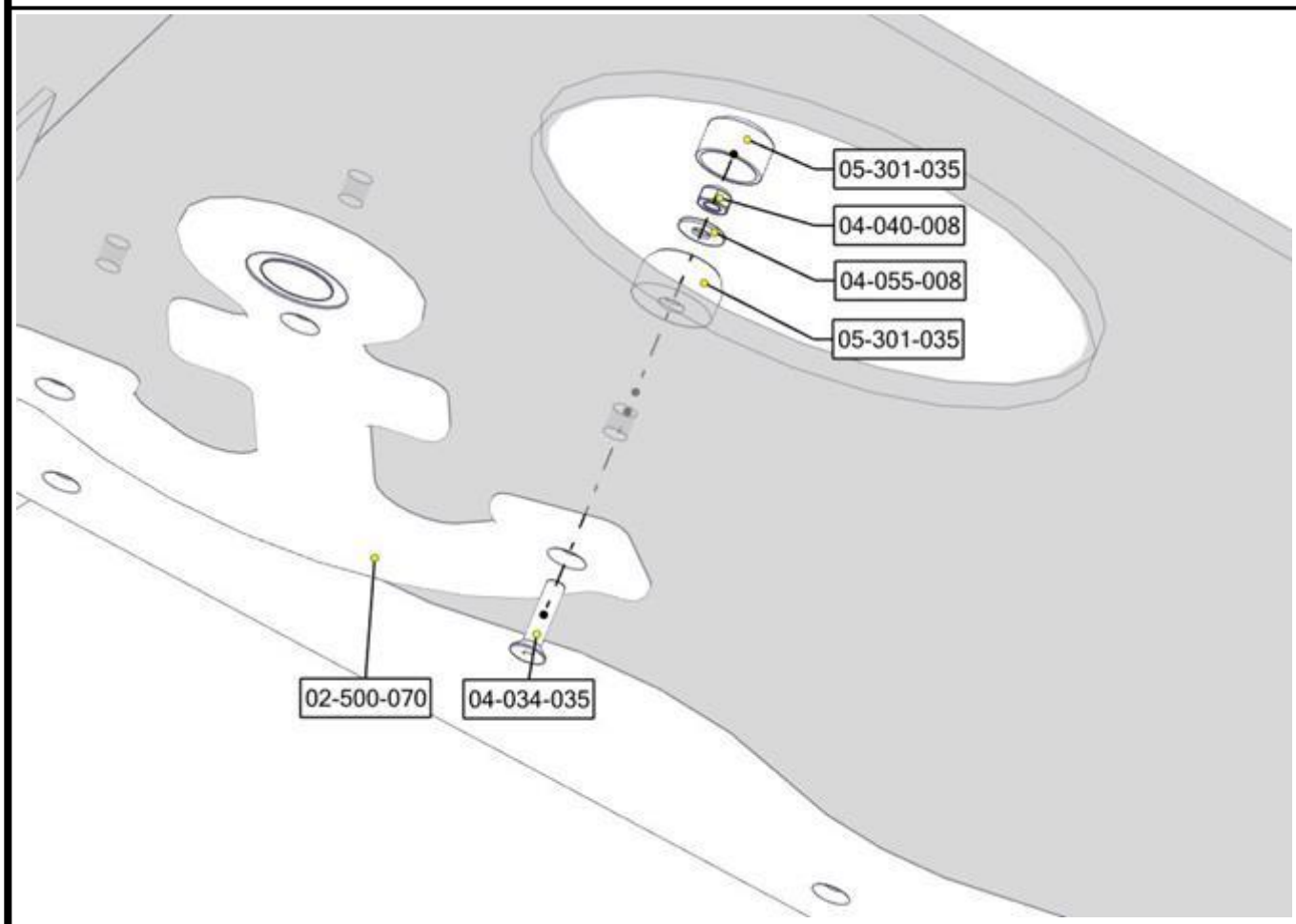
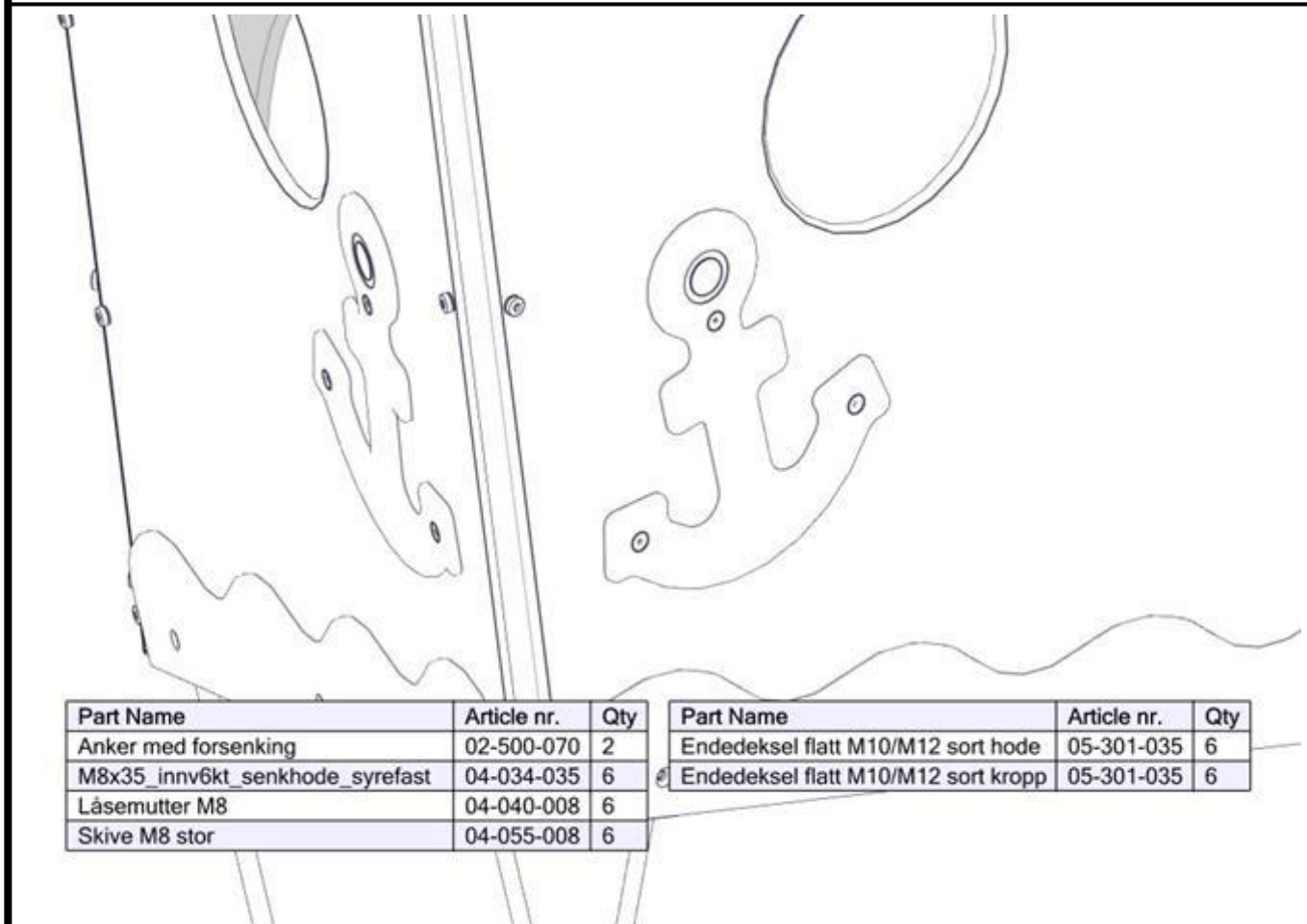

Part Name	Article nr.	Qty
Skive M8 stor	04-055-008	3
Endedeksel flatt M10/M12 sort kropp	05-301-035	3
Endedeksel flatt M10/M12 sort hode	05-301-035	3

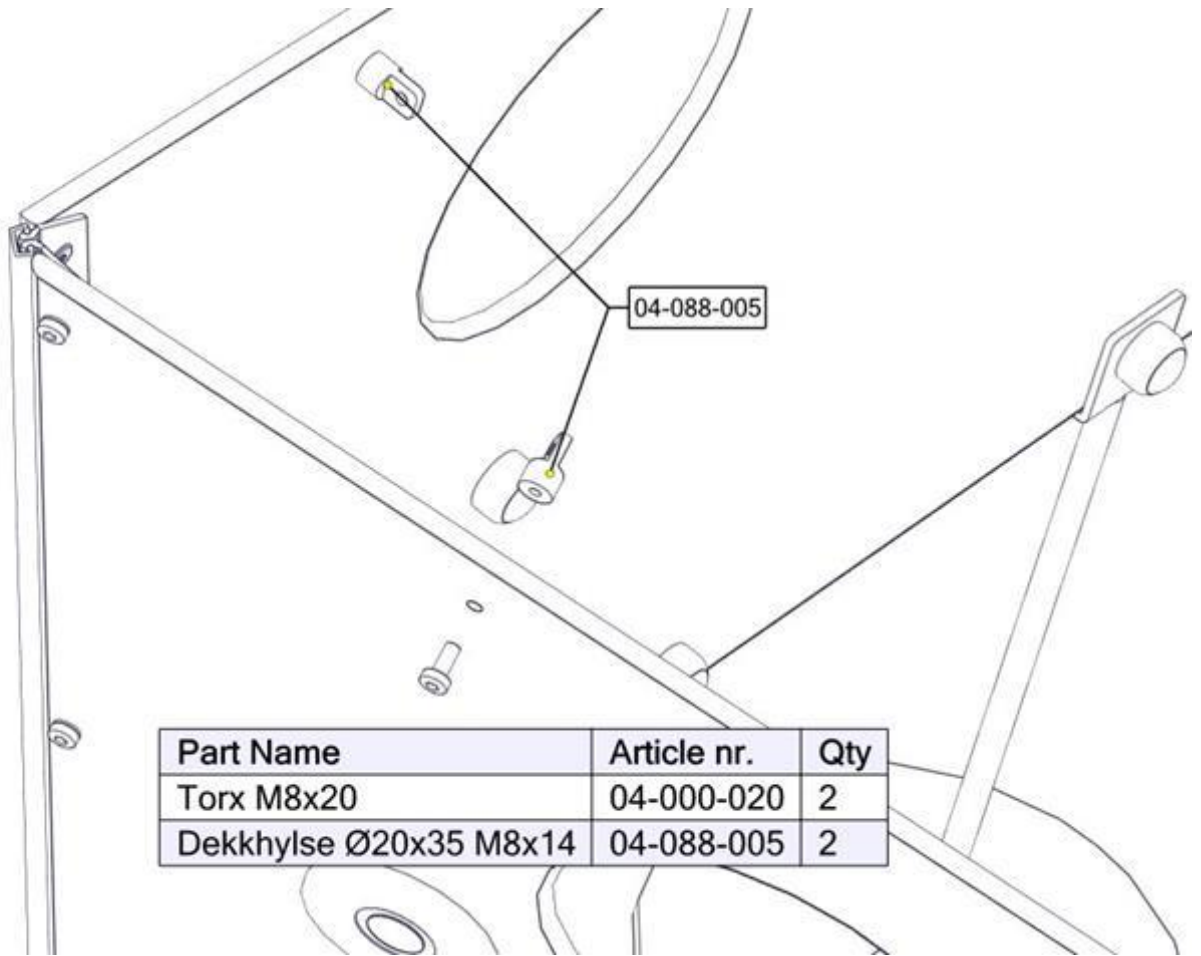



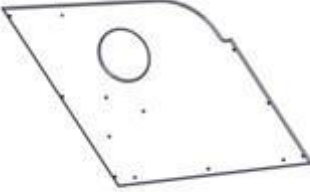

## Montering av lekeapparatet / Assembly instructions / Montering av lekredskapet

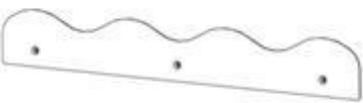

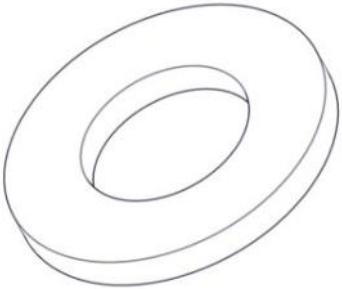
**Montering av lekeapparatet / Assembly instructions / Montering av lekredskapet**

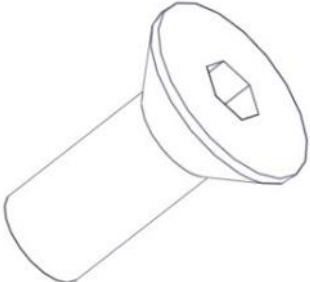

Part Name	Article nr.	Qty
Torx M8x20	04-000-020	2
Dekkhylse Ø20x35 M8x14	04-088-005	2

<b>Boltepakker for / Boltpackage for / Bultpaket för</b>		Sign. _____		
<b>Skute Baug 02-500-097K</b>	<b>Navn</b>	<b>Artnr/dimensjon</b>	<b>Ant</b>	<b>Lev</b>
	Sjørøverskute, Styrhus Sidevegg. Blå	02-500-097	2	
	Sjørøverskute, hengsel front	02-500-096	1	
	Sjørøverskute, hengsel Side	02-500-095	2	
	Torx M8x12  Torx M8x20	04-000-012  04-000-020	18  2	
	Møbelknapp M8x11	04-030-011	18	
	Bolger kort m/ forsenket hull	02-500-076	2	

<b>Boltepakker for / Boltpackage for / Bultpaket för</b>		Sign. _____		
<b>Skute Baug 02-500-097K</b>	<b>Navn</b>	<b>Artnr/dimensjon</b>	<b>Ant</b>	<b>Lev</b>
	Skive M8	04-050-008	18	
	Skive M8 Stor	04-055-008	12	
	Anker med forsenking	02-500-070	2	
	Umbrako med senkhode M8x35	04-034-035	8	
	M8x40	04-034-040	4	
	M8 Låsemutter	04-040-008	12	
	Endedeksel flatt M10/M12 sort hode	05-301-035	12	
	Endedeksel flatt M10/M12 sort kropp	05-301-035	12	



**Boltepakker for / Boltpackage for / Bultpaket för**

Sign. \_\_\_\_\_

Skute Baug 02-500-097K	Navn	Artnr/dimensjon	Ant	Lev
	Stålforankring L=600 m/ knekk	00-100-311	2	
	Stålforankring L=600	00-100-316	2	
	Dekkhylse Ø20x35 M8x14	04-088-005	2	

**Boltepakker for / Boltpackage for / Bultpaket för**

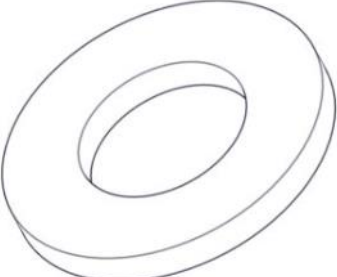
Sign. \_\_\_\_\_

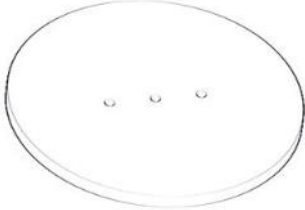
Skute Baug 02-500-097K	Navn	Artnr/dimensjon	Ant	Lev
	<b>Fundament Nedgravning</b>			
	Torx M8x35	04-000-035	8	
	Skive M8	04-050-008	16	
	M8 Låsemutter	04-040-008	8	
	Fundamentplate	00-003-103	4	



MTK: 25-03-2020

Artikkelnummer anker endret til forsenking anker 02-500-070

IB: 15.12.2020

Bølger korte endret fra HDPE til HPL med forsenket hull.

MTK 27-02-2023

Lang forankring 00-100-316