

**Boltpakke****Bolt package****Bultpaket**

Produkt nr. / Product no. / Produkt nr.

04-900-012**Boltpakke portal m/**

Ord. nr. _____

Dato. _____



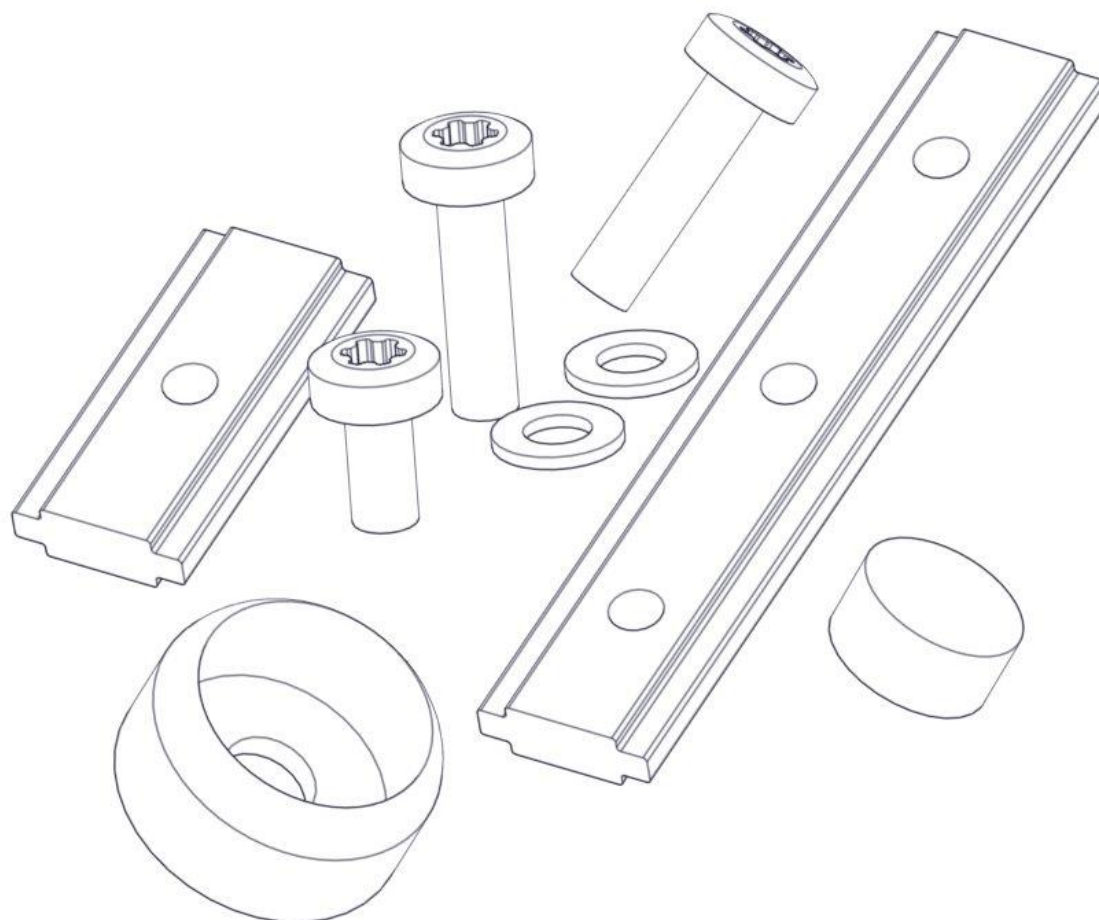

Sign. _____



**søve**

Søve AS
Grønnvoldveien 290
3830 Ulefoss - Norway
Tlf: +47 35 94 65 65
www.sove.no

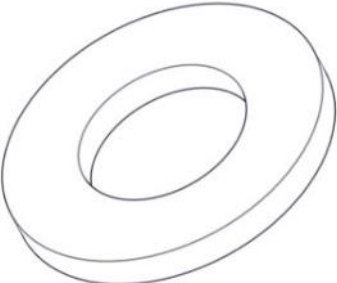
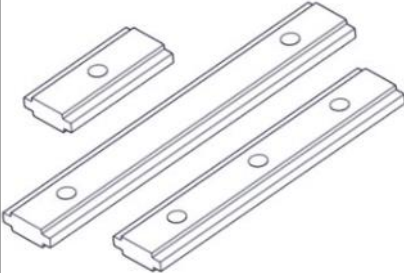
**søve**

Søve AB
EA Rosengrensgatan 32
421 31 Västra Frölunda
Phone: +46 (0)31 773 97 00
www.sove.se

Boltpakke / Bolt package / Bultpaket		Sign. _____		
04-900-012	Navn	Artnr/dimensjon	Ant	Lev
	Torx M8x35	04-000-035	32	
	Torx M8x45	04-000-045	2	
	Torx M8x50	04-000-050	2	
	Låsemutter M8	04-040-008	14	
	Skive M8	04-050-008	18	
	Brikke 120 3xM8	04-060-120	8	
	Brikke 160 3xM8	04-060-160	2	
	Plugg 9-11 mm	04-090-002	4	

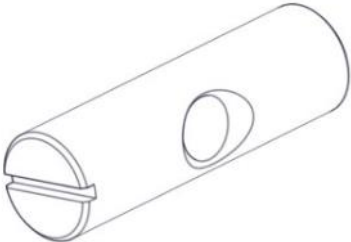
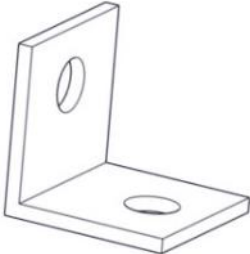
Boltpakke / Bolt package / Bultpaket		Sign. _____		
04-900-012	Navn	Artnr/dimensjon	Ant	Lev
	Endedeksel flat M8 Kropp Sort	05-301-033	8	
	Endedeksel flat M8 Hode Sort	05-301-033	8	
	Hylsemutter Ø12x40 1xM8	04-019-040	2	
	Vinkel 35x35x35x3 11mm hull	04-070-036	2	