

N**Monteringsanvisning****EN****Assembly Instructions****S****Monteringsanvisning**

Produkt nr. / Product no. / Produkt nr.

06-200-262K

Blågrønn

Ord. nr. _____

Dato. _____

Sign. _____

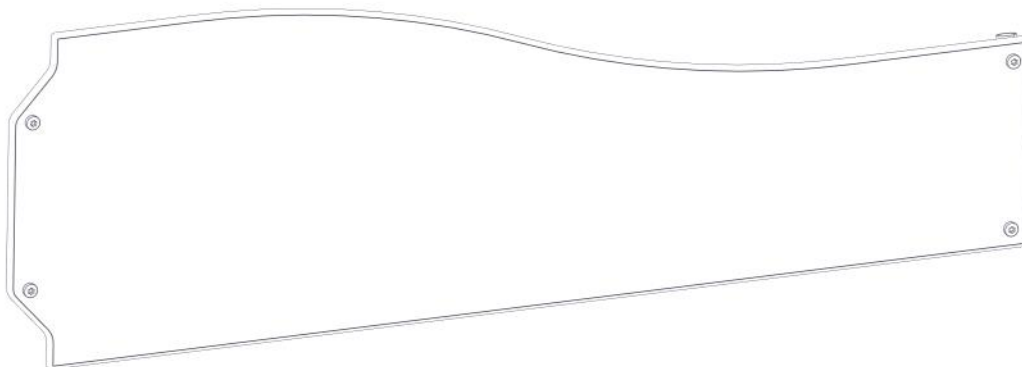
**søve**



Søve AS
Grønnvoldveien 290
3830 Ulefoss - Norway
Tlf: +47 35 94 65 65
www.sove.no

**søve**

Søve AB
EA Rosengrensgatan 32
421 31 Västra Frölunda
Phone: +46 (0)31 773 97 00
www.sove.se

Boltepakker for / Boltpackage for / Bultpaket för

Sign. _____

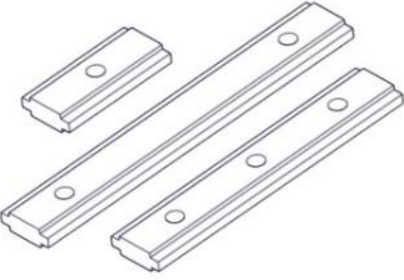
Vegg 400 male/250 rett 06-200-262K	Navn	Artnr/dimensjon	Ant	Lev
	Vegg 400 male/250 rett 1250 x 250/400 Blågrønn	06-200-262	1	
	Torx M8x30	04-000-030	4	
	Brikke 50 1xM8	04-060-050	2	

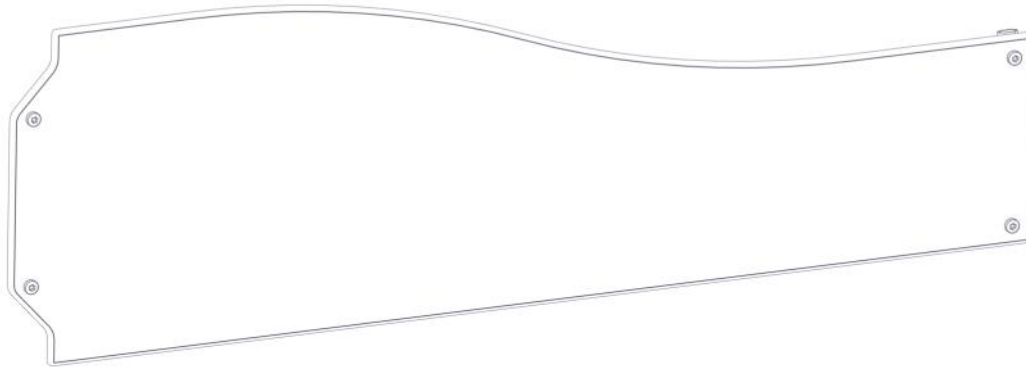
Montering av lekeapparatet / Assembly instructions / Montering av lekredskapet

PartName	Artnr	Antall
Brikke 50 1XM8	04-060-050	2
Torx M8x30	04-000-030	4
Vegg sandkasse 400-250	06-200-262	1

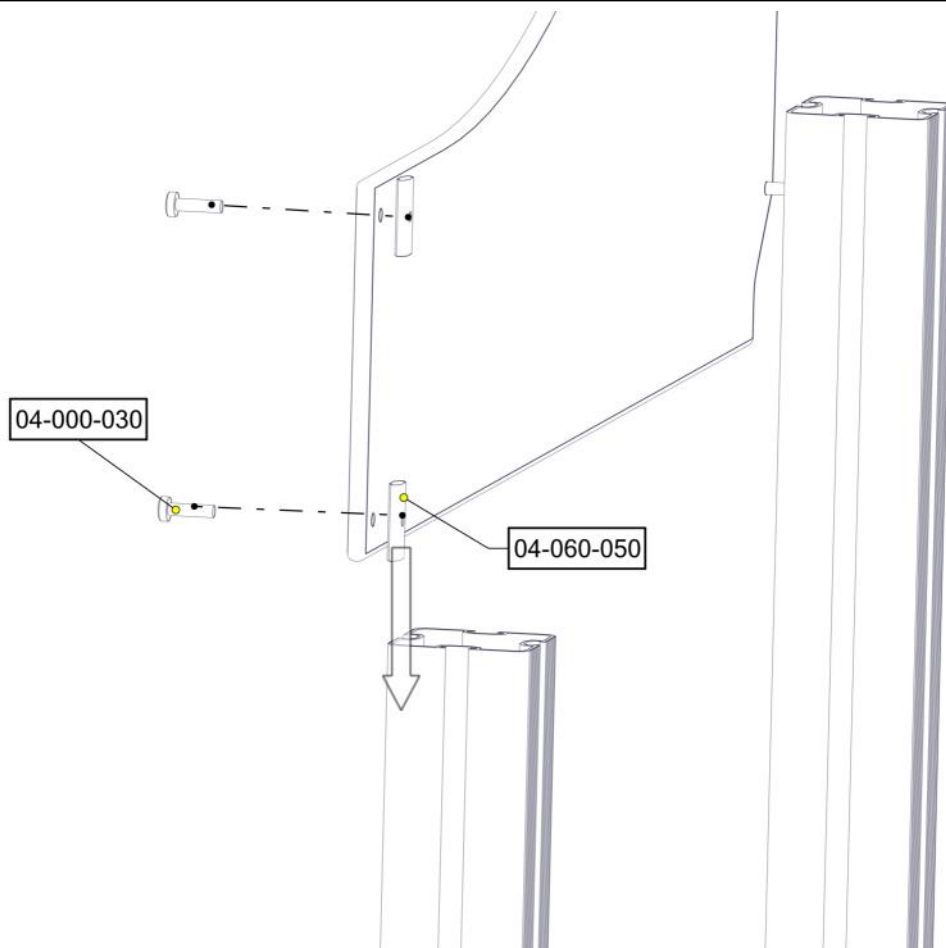

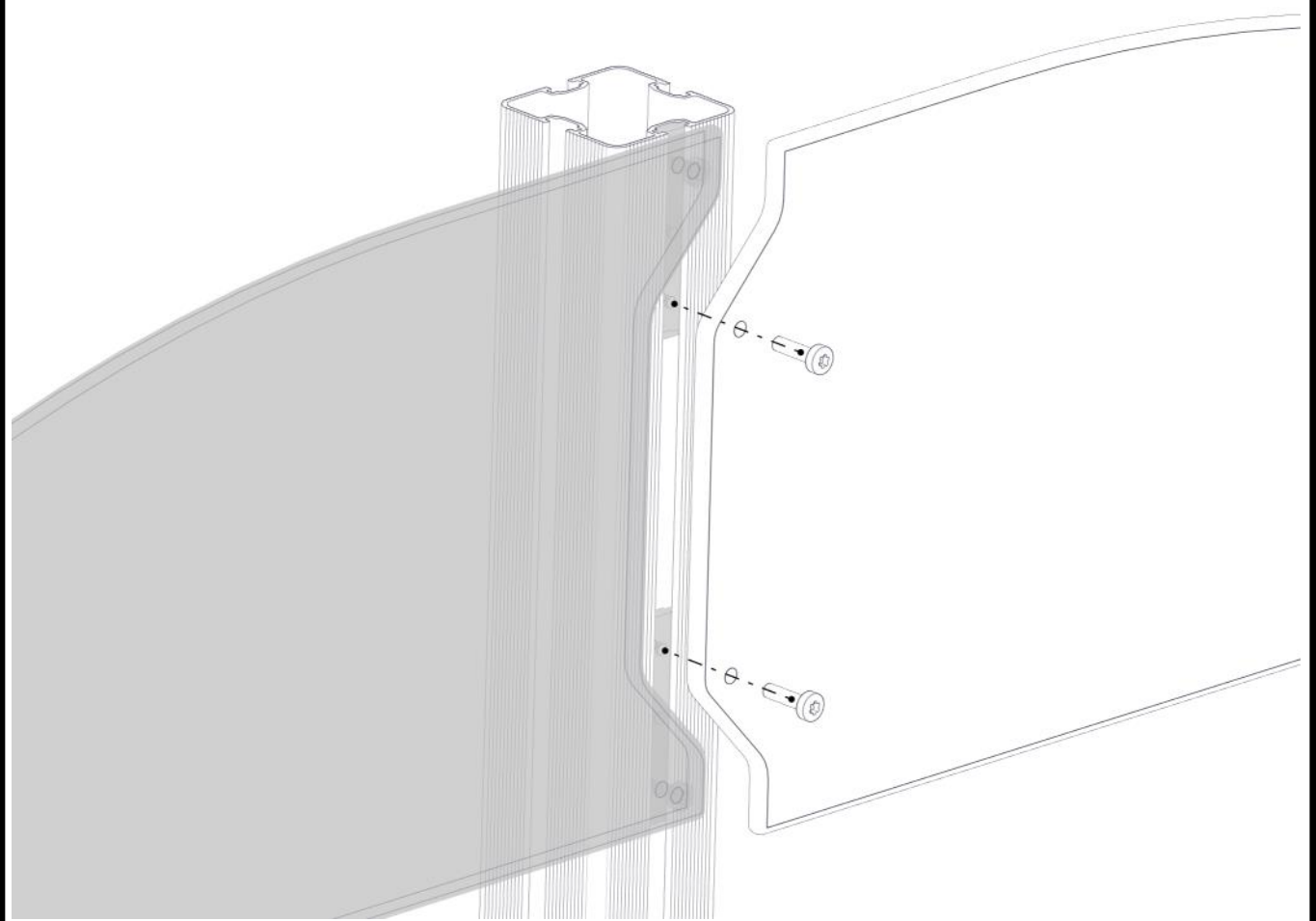
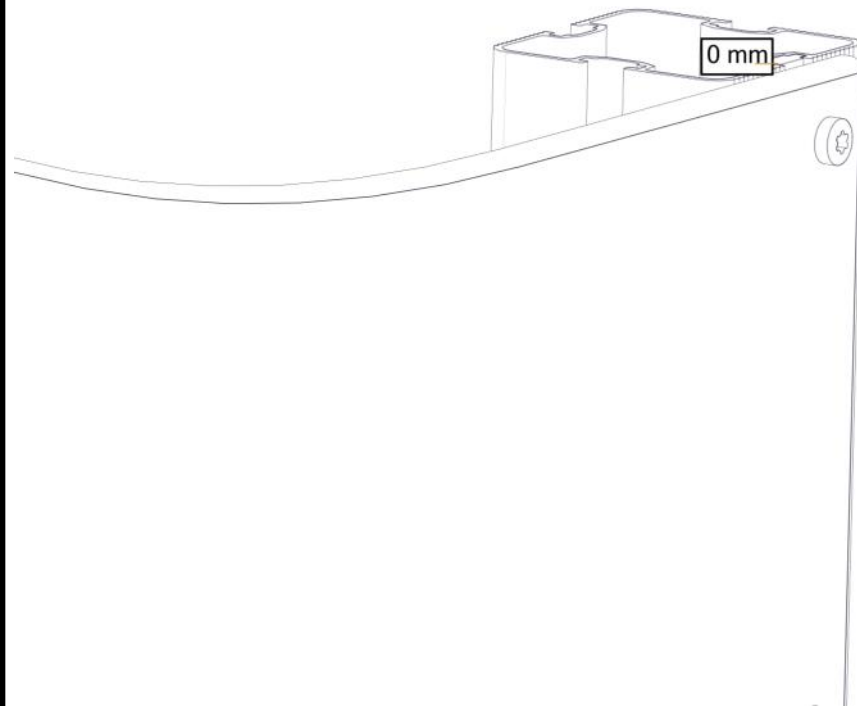

Montering av lekeapparatet / Assembly instructions / Montering av lekredskapet



Boltepakker for / Boltpackage for / Bultpaket för

Sign. _____

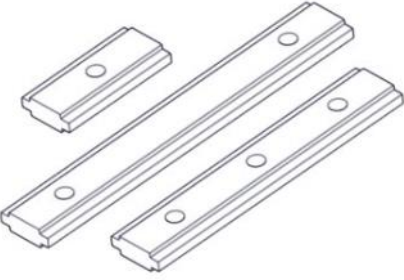
Vegg 400 male/250 rett 06-200-262K	Navn	Artnr/dimensjon	Ant	Lev
	Vegg 400 male/250 rett 1250 x 250/400 Blågrønn	06-200-262	1	
	Torx M8x30	04-000-030	4	
	Brikke 50 1xM8	04-060-050	2	