

N**Monteringsanvisning****EN****Assembly Instructions****S****Monteringsanvisning**

Produkt nr. / Product no. / Produkt nr.

06-200-515K**Grå**

Ord. nr. _____

Dato. _____

Sign. _____

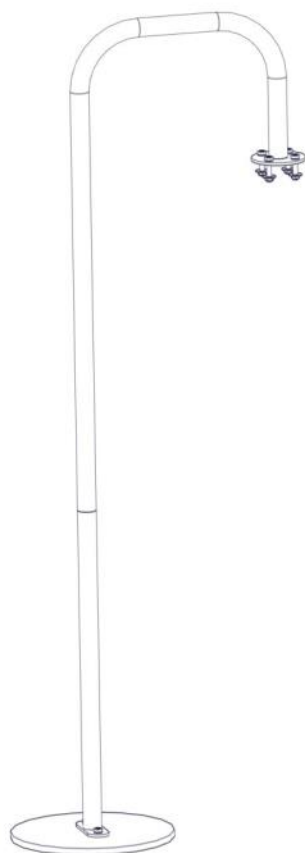





Søve AS
Grønnvoldveien 290
3830 Ulefoss - Norway
Tlf: +47 35 94 65 65
www.sove.no

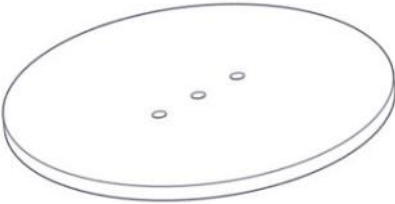

Søve AB
EA Rosengrensgatan 32
421 31 Västra Frölunda
Phone: +46 (0)31 773 97 00
www.sove.se

Boltepakker for / Boltpackage for / Bultpaket för

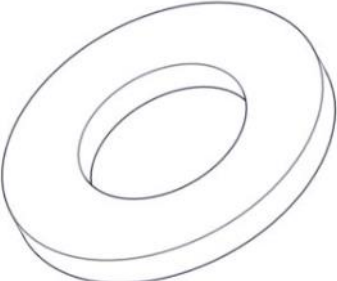
Sign. _____

Grå 06-200-515K	Navn	Artnr/ dimensjon	Ant	Lev
	MudTable rør H600 Grå	06-200-515	1	
	Fundamentplate	000-003-103	1	
	Torx M8x35 Rorx M8x40	04-000-035 04-000-040	2 4	
	Skive M8 Skive M8 stor	04-050-008 04-055-008	8 4	
	Låsemutter M8	04-040-008	6	

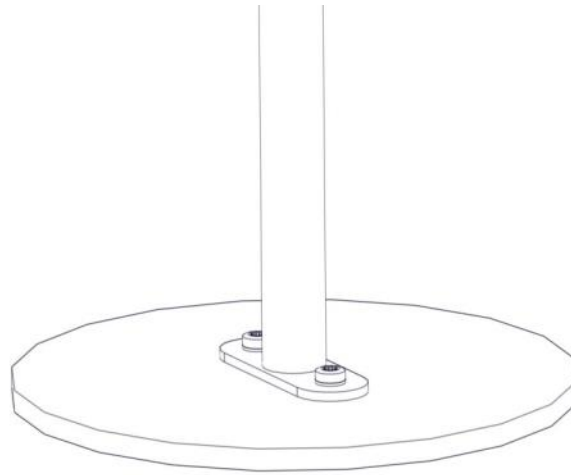

Part Name	Article nr.	Qty
Torx M8x35	04-000-035	2
Skive M8	04-050-008	4
Mudbord rør H=500	06-200-515	1

Part Name	Article nr.	Qty
Låsemutter M8	04-040-008	2
Fundament plate	00-003-103	1

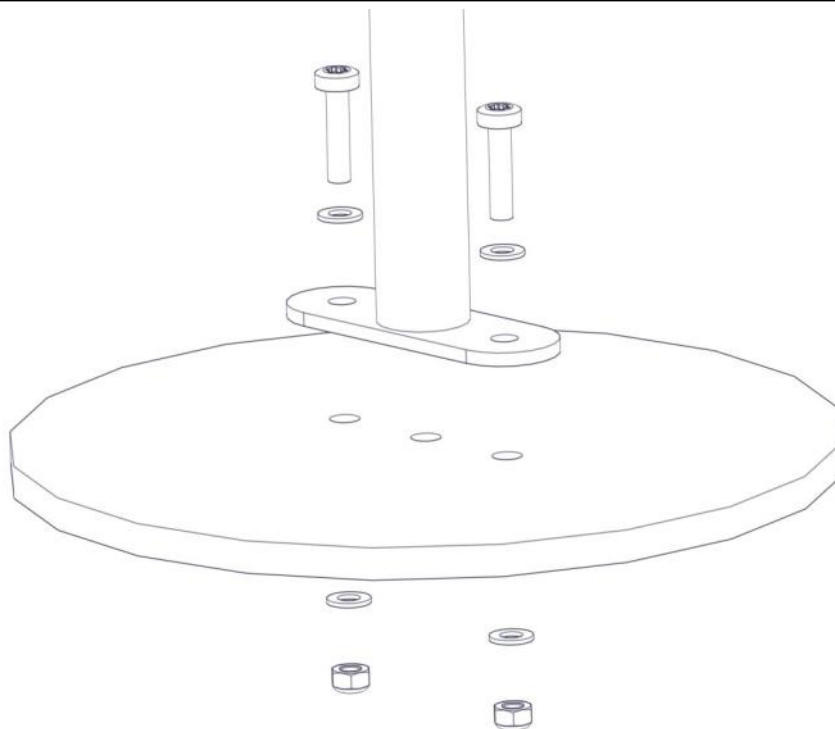

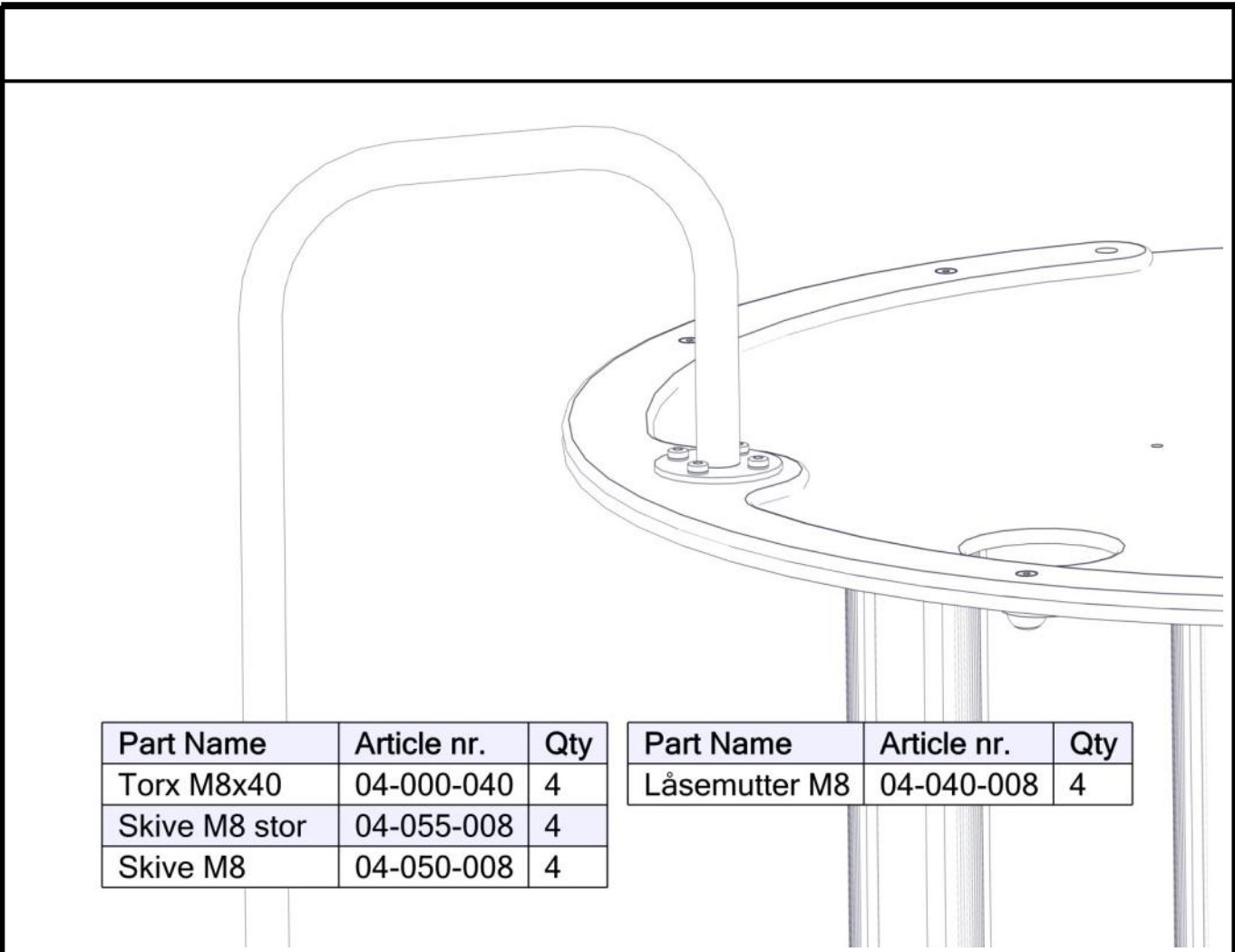





Part Name	Article nr.	Qty
Torx M8x40	04-000-040	4
Skive M8 stor	04-055-008	4
Skive M8	04-050-008	4

Part Name	Article nr.	Qty
Låsemutter M8	04-040-008	4

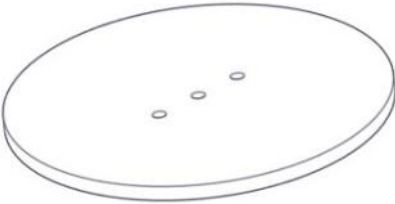
Boltepakker for / Boltpackage for / Bultpaket för

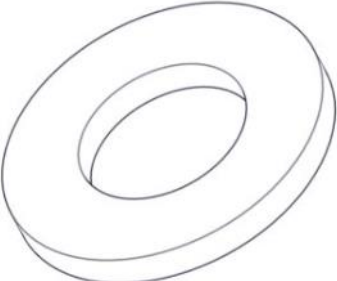
Sign. _____

Grå 06-200-515K	Navn	Artnr/ dimensjon	Ant	Lev
	MudTable rør H600 Grå	06-200-515	1	
	Fundamentplate	000-003-103	1	
	Torx M8x35 Rorx M8x40	04-000-035 04-000-040	2 4	
	Skive M8 Skive M8 stor	04-050-008 04-055-008	8 4	
	Låsemutter M8	04-040-008	6	