

N**Monteringsanvisning****EN****Assembly Instructions****S****Monteringsanvisning**

Produkt nr. / Product no. / Produkt nr.

07-200-122K**Grå**

Ord. nr. _____

Dato. _____

Sign. _____

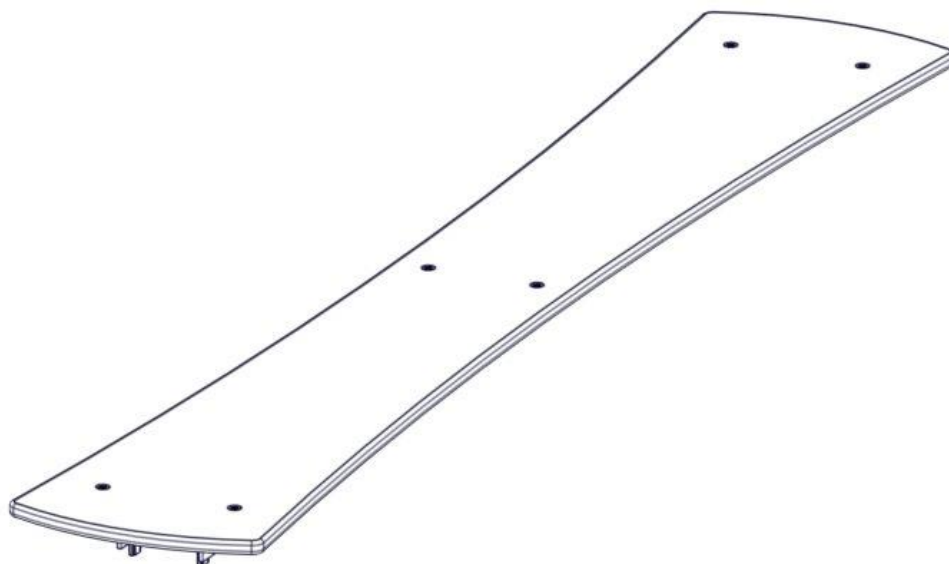
**søve**





Søve AS
Grønnvoldveien 290
3830 Ulefoss - Norway
Tlf: +47 35 94 65 65
www.sove.no

**søve**

Søve AB
EA Rosengrensgatan 32
421 31 Västra Frölunda
Phone: +46 (0)31 773 97 00
www.sove.se

Boltepakker for / Boltpackage for / Bultpaket för

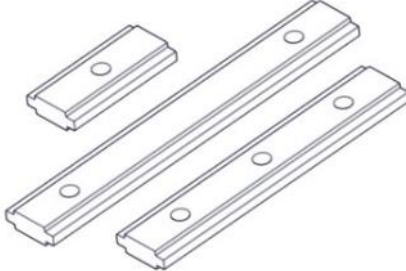
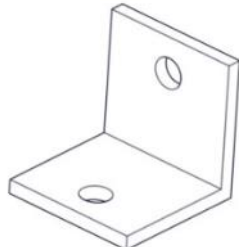
Sign. _____

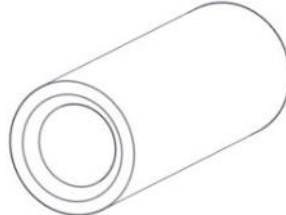
Sittebrett 0 gr grå 07-200-122K	Navn	Artnr/dimensjon	Ant	Lev
	Sittebrett 0gr 6 hull Grå	07-200-122	1	
	Torx M8x20 Torx M8x25	04-000-020 04-000-025	8 4	
	Brikke 50 1xM8	04-060-050	4	
	Vinkel 50x50x50x5 11mm hull	04-070-050	4	
	Låsemutter M8	04-040-008	4	
	Gjengehylse M8x40	04-021-008	2	

Boltepakker for / Boltpackage for / Bultpaket för

Sign. _____.

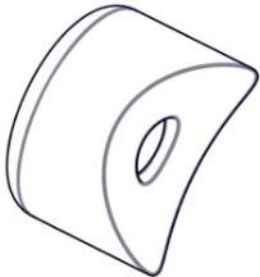
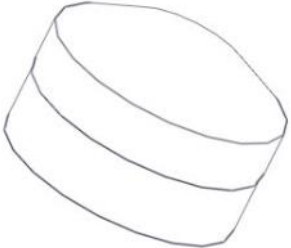
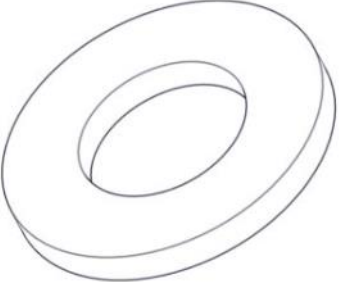
Sittbrett 0 gr grå 07-200-122K	Navn	Artnr/dimensjon	Ant	Lev
	Plast rørfeste, kropp	05-301-036	2	
	Plast rørfeste, hode	05-301-036	2	
	Skive M8 stor	04-055-036	2	

Montering av lekeapparatet / Assembly instructions / Montering av lekredskapet

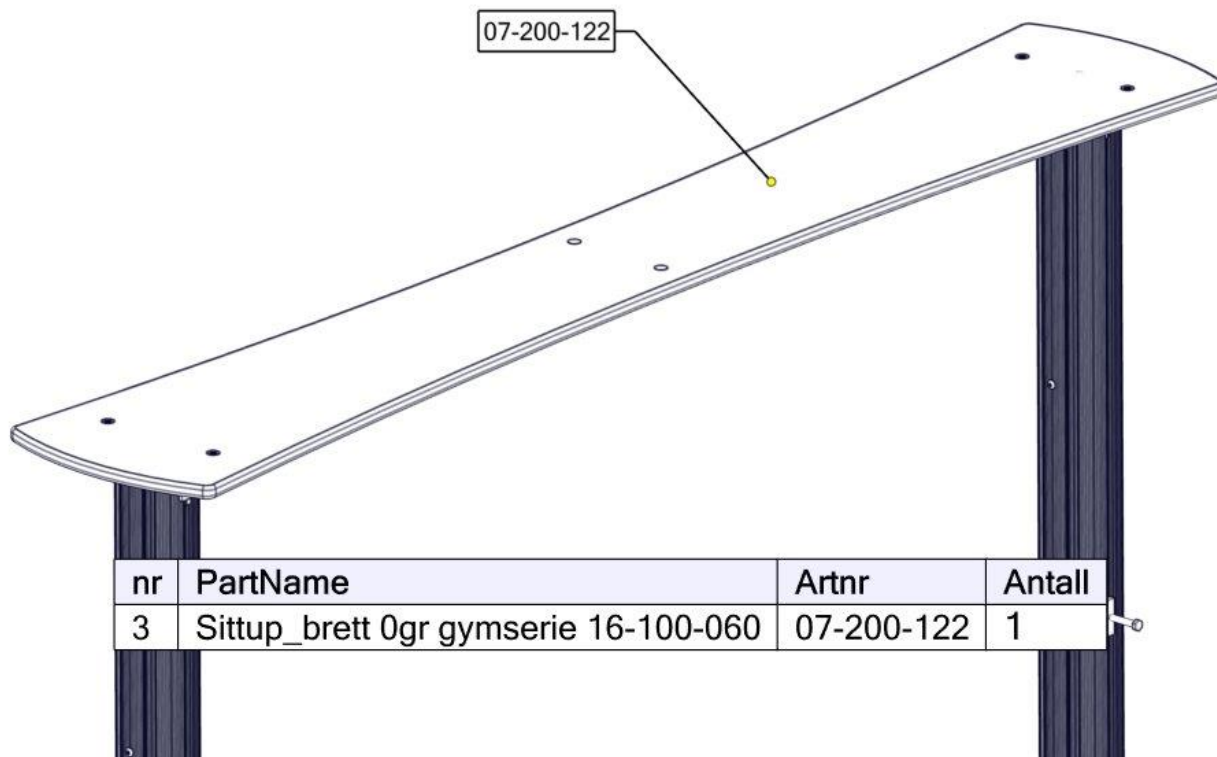

nr	PartName	Artnr	Antall
3	Sittup_brett 0gr gymserie 16-100-060	07-200-122	1

2x

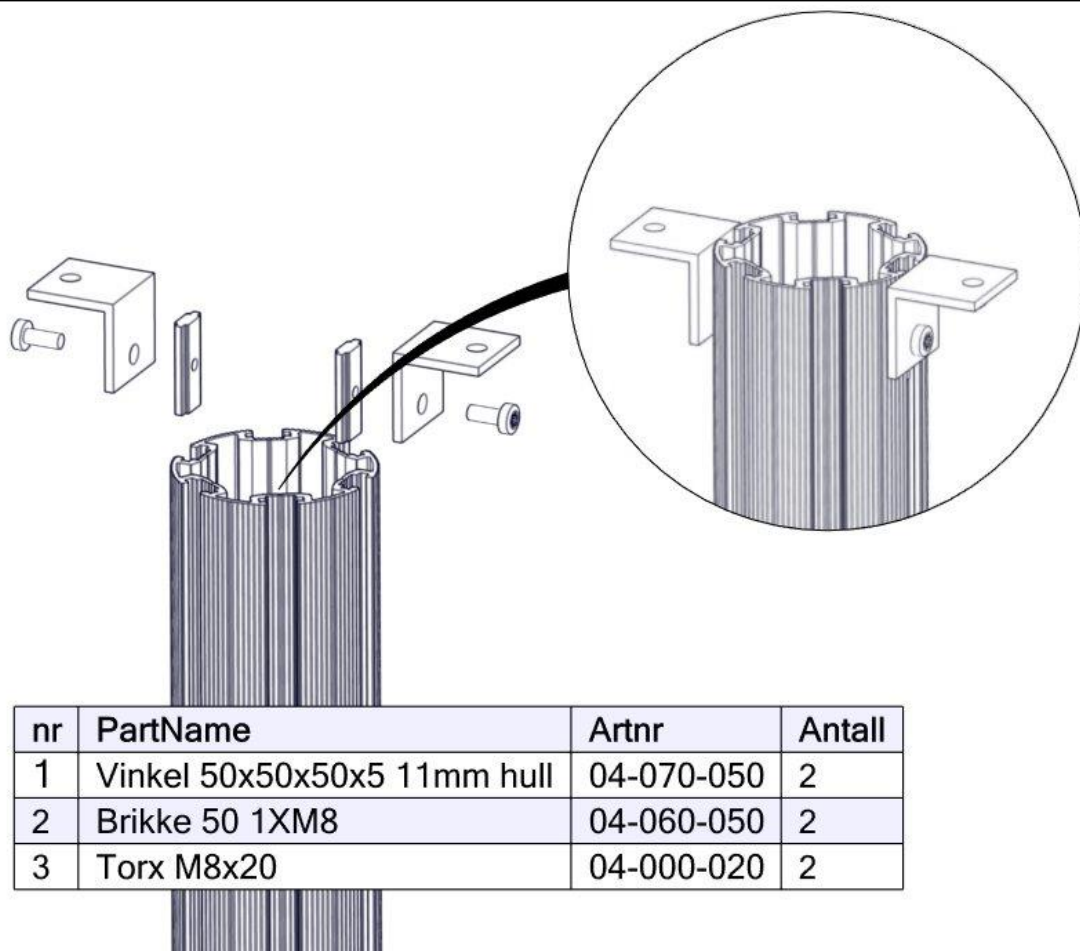

nr	PartName	Artnr	Antall
1	Vinkel 50x50x50x5 11mm hull	04-070-050	2
2	Brikke 50 1XM8	04-060-050	2
3	Torx M8x20	04-000-020	2

Montering av lekeapparatet / Assembly instructions / Montering av lekredskapet

2x

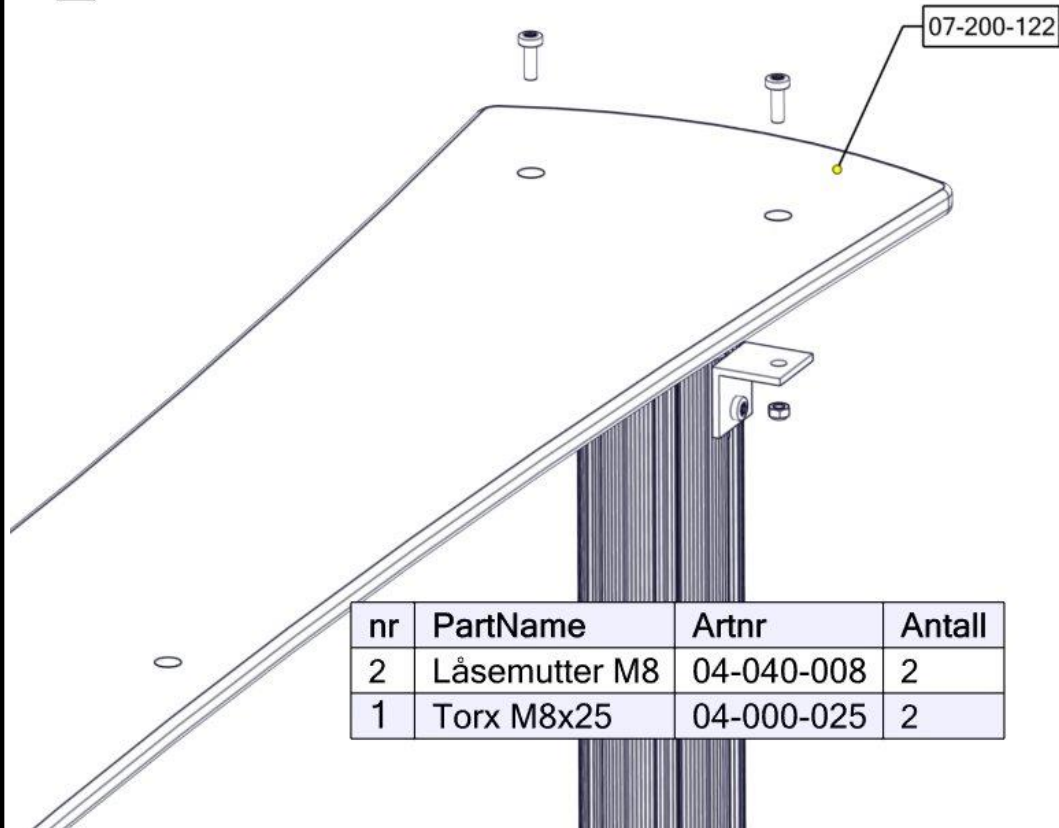

nr	PartName	Artnr	Antall
2	Låsemutter M8	04-040-008	2
1	Torx M8x25	04-000-025	2

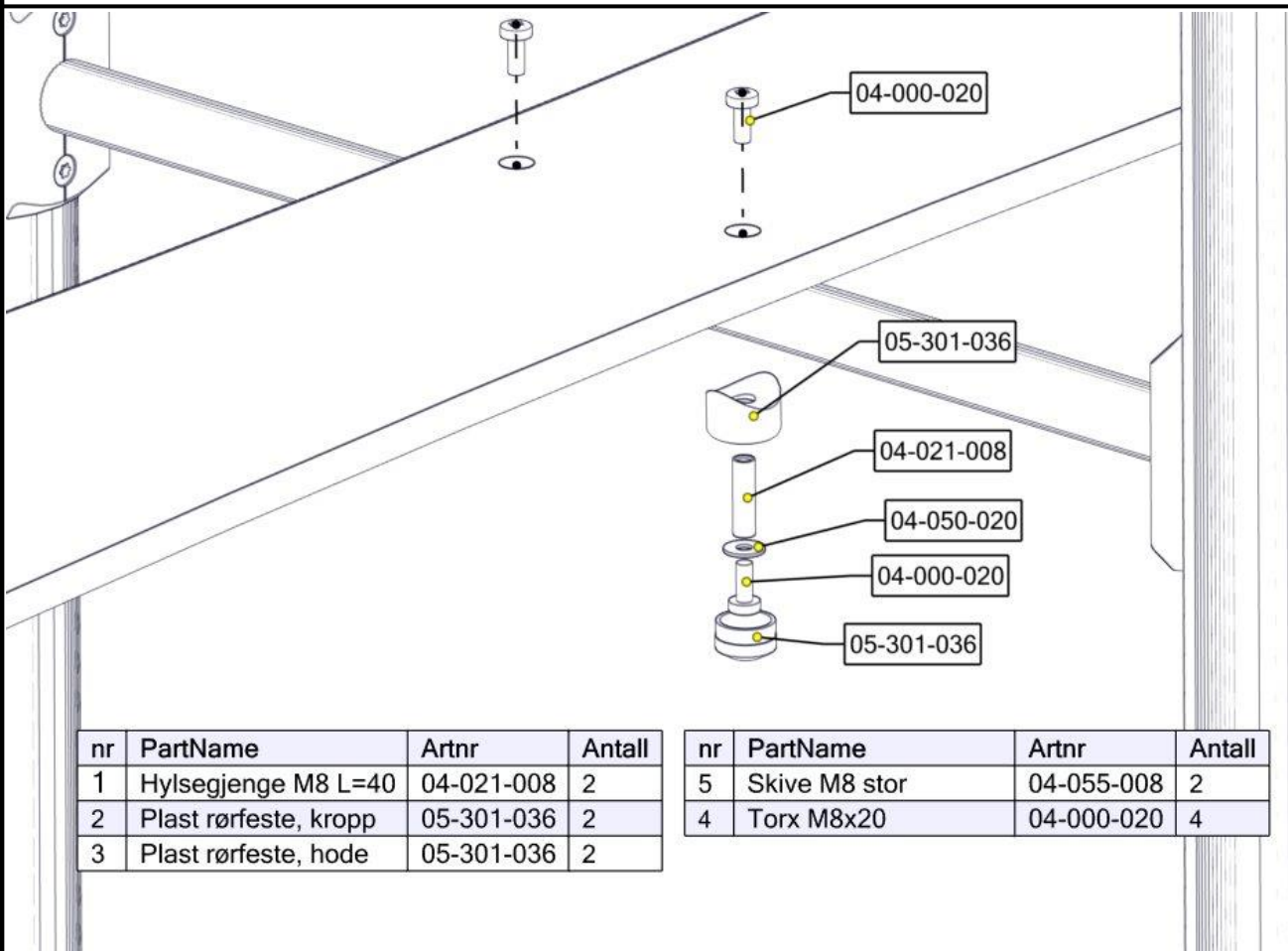





nr	PartName	Artnr	Antall
1	Hylsegjenge M8 L=40	04-021-008	2
2	Plast rørfeste, kropp	05-301-036	2
3	Plast rørfeste, hode	05-301-036	2

nr	PartName	Artnr	Antall
5	Skive M8 stor	04-055-008	2
4	Torx M8x20	04-000-020	4

Boltepakker for / Boltpackage for / Bultpaket för

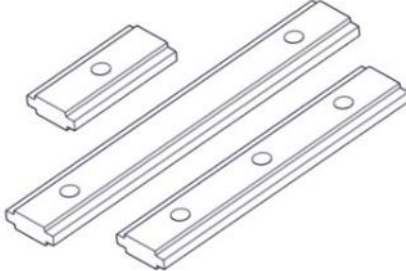
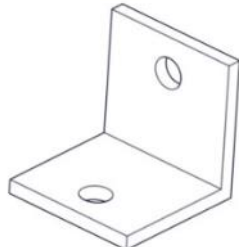
Sign. _____

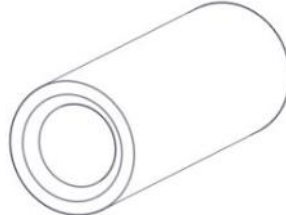
Sittebrett 0 gr grå 07-200-122K	Navn	Artnr/dimensjon	Ant	Lev
	Sittebrett 0gr 6 hull Grå	07-200-122	1	
	Torx M8x20 Torx M8x25	04-000-020 04-000-025	8 4	
	Brikke 50 1xM8	04-060-050	4	
	Vinkel 50x50x50x5 11mm hull	04-070-050	4	
	Låsemutter M8	04-040-008	4	
	Gjengehylse M8x40	04-021-008	2	

Boltepakker for / Boltpackage for / Bultpaket för

Sign. _____.

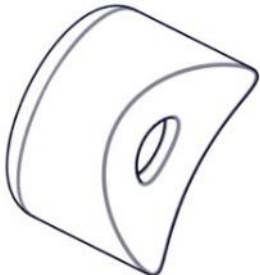
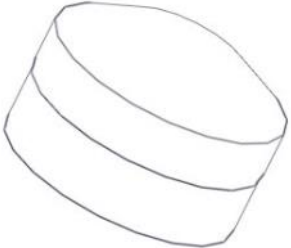
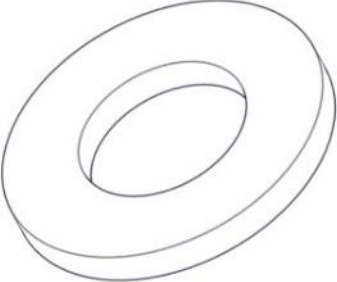
Sittebrett 0 gr grå 07-200-122K	Navn	Artnr/dimensjon	Ant	Lev
	Plast rørfeste, kropp	05-301-036	2	
	Plast rørfeste, hode	05-301-036	2	
	Skive M8 stor	04-055-036	2	

15.04.2024 MNO

Byttet ut M8stor skive til polifyx M10 til plast deler.