

**Monteringsanvisning****Assembly Instructions****Monteringsanvisning**

Produkt nr. / Product no. / Produkt nr.

07-200-123K**Grå**

Ord. nr. _____

Dato. _____

Sign. _____

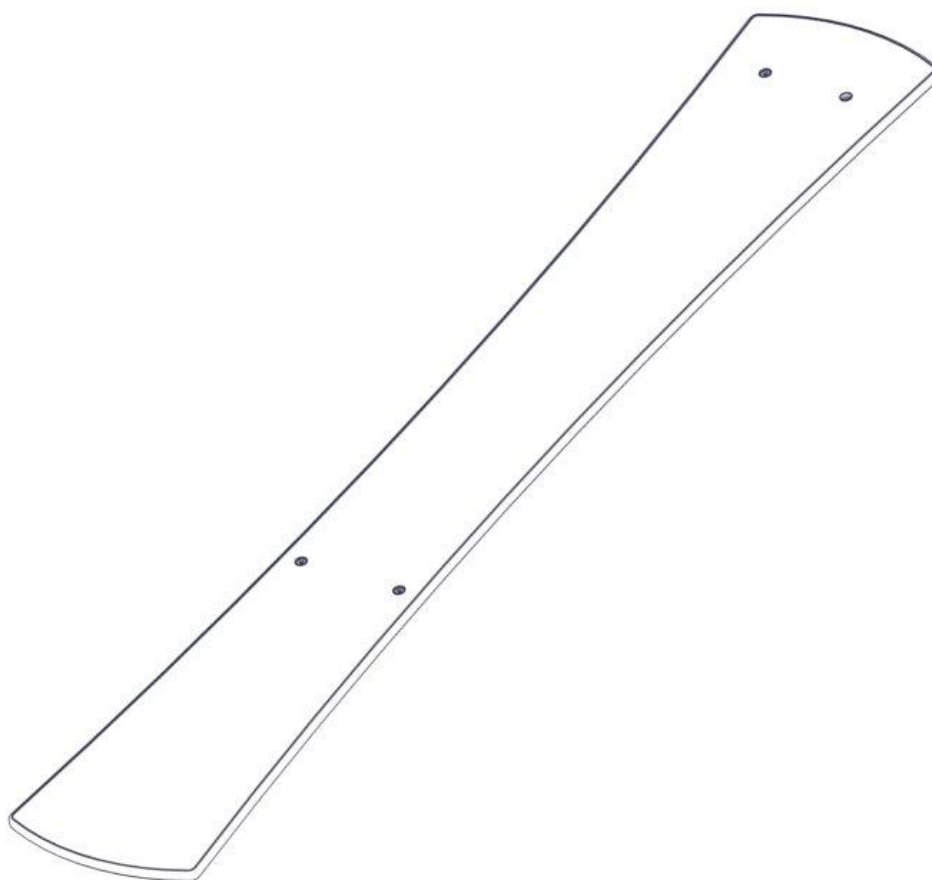
**søve**





Søve AS
Grønnvoldveien 290
3830 Ulefoss - Norway
Tlf: +47 35 94 65 65
www.sove.no

**søve**

Søve AB
EA Rosengrensgatan 32
421 31 Västra Frölunda
Phone: +46 (0)31 773 97 00
www.sove.se

Boltepakker for / Boltpackage for / Bultpaket för

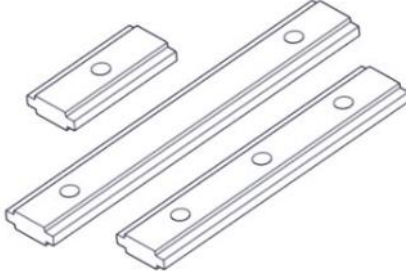
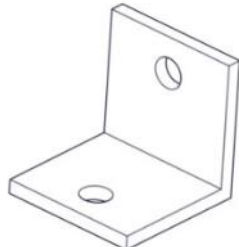
Sign. _____

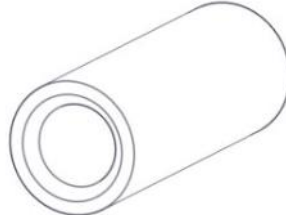
Sittebrett 15 gr grå 07-200-123K	Navn	Artnr/dimensjon	Ant	Lev
	Sittebrett 15gr 4 hull Grå	07-200-123	1	
	Torx M8x20 Torx M8x25	04-000-020 04-000-025	6 2	
	Brikke 50 1xM8	04-060-050	2	
	Vinkel 50x50x50x5 11mm hull	04-070-050	2	
	Låsemutter M8	04-040-008	2	
	Gjengehylse M8x40	04-021-008	2	

Boltepakker for / Boltpackage for / Bultpaket för

Sign. _____.

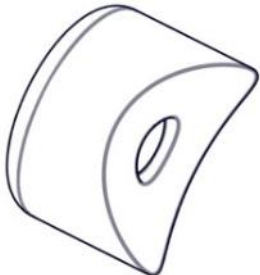
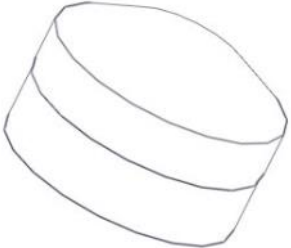
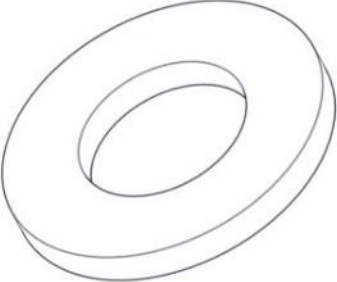
Sittbrett 15 gr grå 07-200-123K	Navn	Artnr/dimensjon	Ant	Lev
	Plast rørfeste, kropp	05-301-036	2	
	Plast rørfeste, hode	05-301-036	2	
	Skive M8 stor	04-055-008	2	

Montering av lekeapparatet / Assembly instructions / Montering av lekredskapet

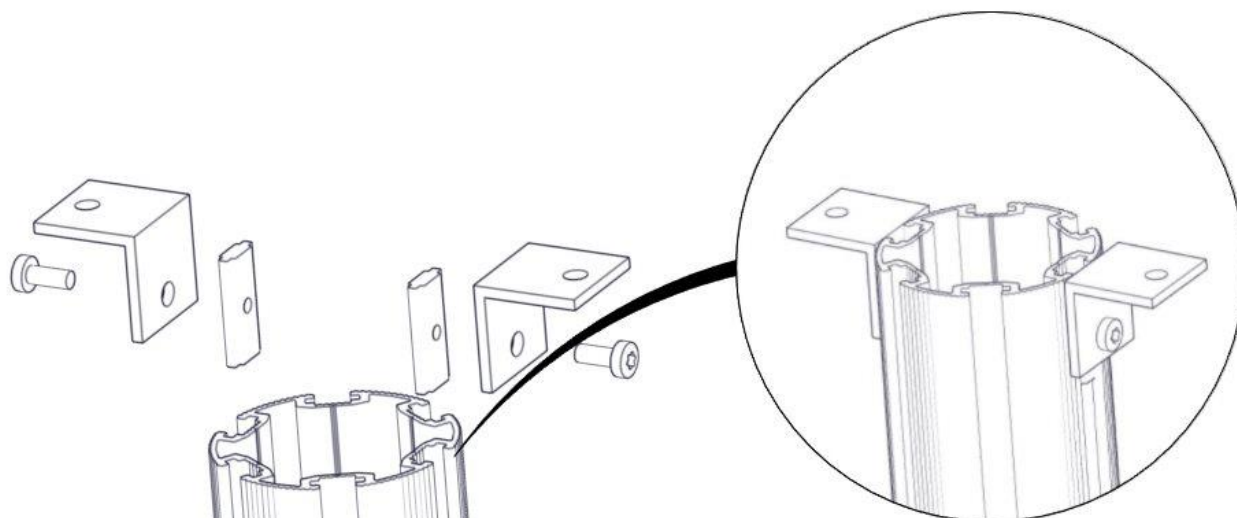

Part Name	Article nr.	Qty
Vinkel 50x50x50x5 11mm hull	04-070-050	2
Torx M8x20	04-000-020	2
Brikke 50 1XM8	04-060-050	2

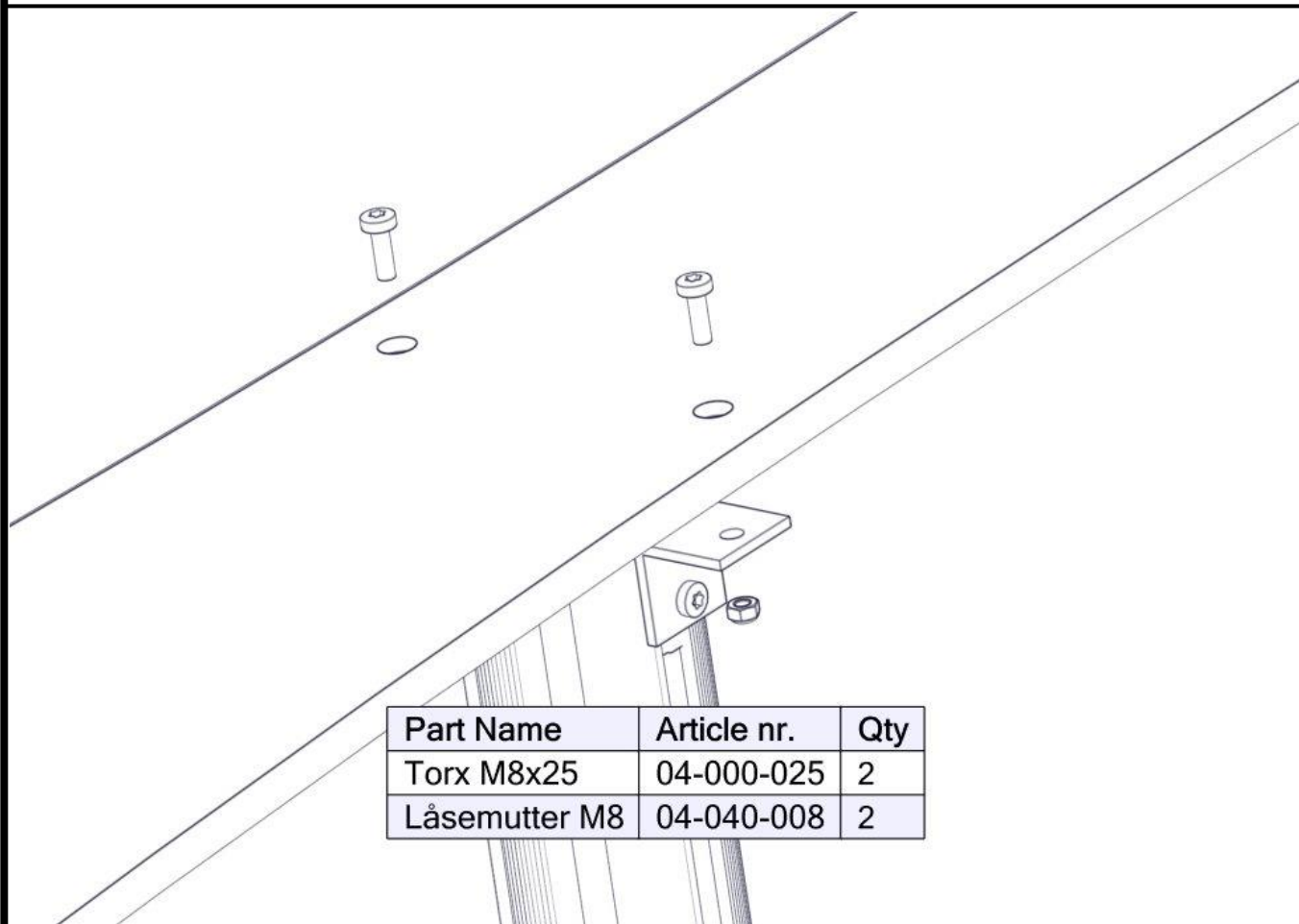



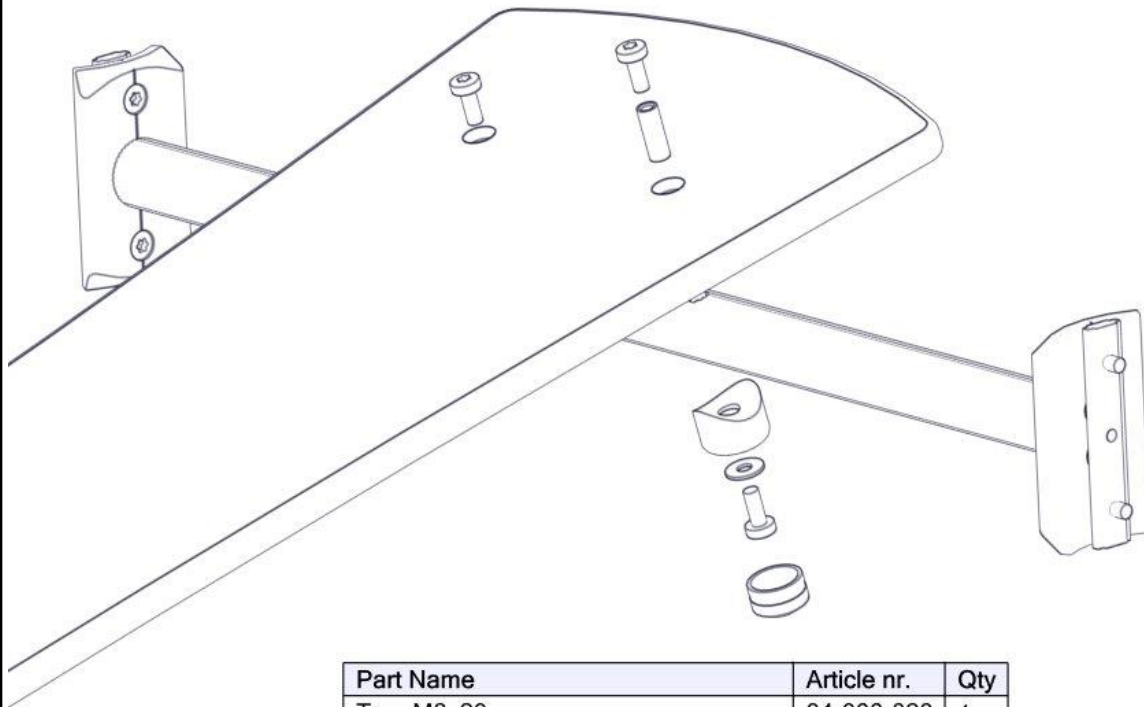

Part Name	Article nr.	Qty
Torx M8x25	04-000-025	2
Låsemutter M8	04-040-008	2

Montering av lekeapparatet / Assembly instructions / Montering av lekredskapet

Part Name	Article nr.	Qty
Torx M8x20	04-000-020	4
Skive M8 stor	04-055-008	2
Sittup_brett 15gr gymserie 16-100-060	07-200-123	1
Plast rørfeste,	05-301-036	4
Hylsegjenge M8 L=30	04-021-007	2

Boltepakker for / Boltpackage for / Bultpaket för

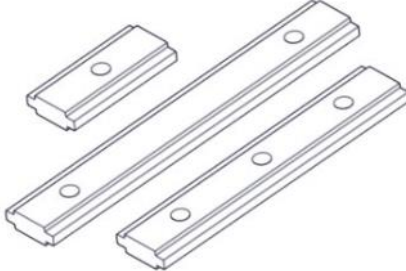
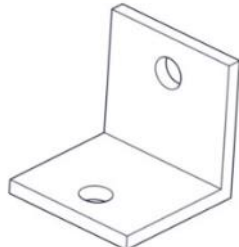
Sign. _____

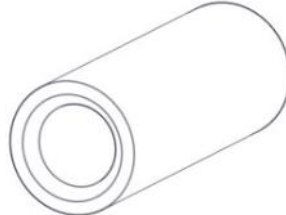
Sittebrett 15 gr grå 07-200-123K	Navn	Artnr/dimensjon	Ant	Lev
	Sittebrett 15gr 4 hull Grå	07-200-123	1	
	Torx M8x20 Torx M8x25	04-000-020 04-000-025	6 2	
	Brikke 50 1xM8	04-060-050	2	
	Vinkel 50x50x50x5 11mm hull	04-070-050	2	
	Låsemutter M8	04-040-008	2	
	Gjengehylse M8x40	04-021-008	2	

Boltepakker for / Boltpackage for / Bultpaket för

Sign. _____.

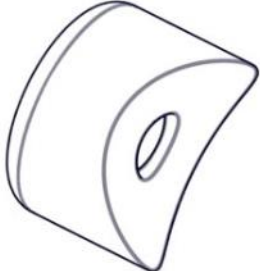
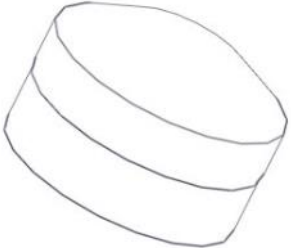
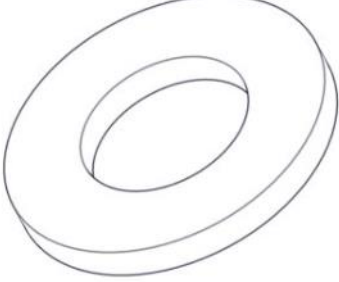
Sittbrett 15 gr grå 07-200-123K	Navn	Artnr/dimensjon	Ant	Lev
	Plast rørfeste, kropp	05-301-036	2	
	Plast rørfeste, hode	05-301-036	2	
	Skive M8 stor	04-055-008	2	