

N**Monteringsanvisning****EN****Assembly Instructions****S****Monteringsanvisning**

Produkt nr. / Product no. / Produkt nr.

07-200-155K**Grønn**

Ord. nr. _____

Dato. _____



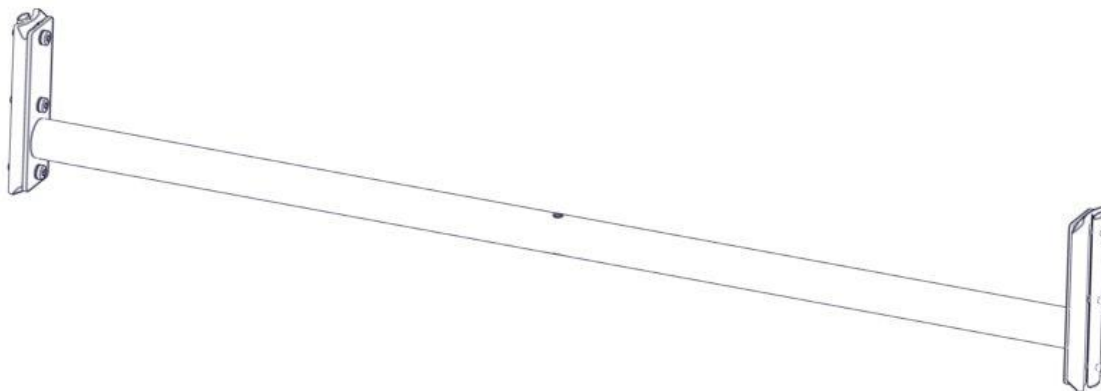

Sign. _____

**søve**

Søve AS
Grønnvoldveien 290
3830 Ulefoss - Norway
Tlf: +47 35 94 65 65
www.sove.no

**søve**

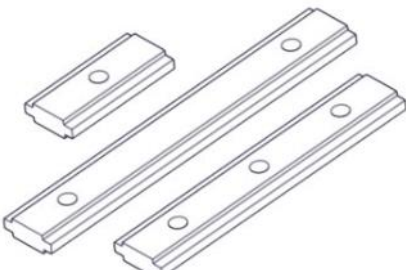
Søve AB
EA Rosengrensgatan 32
421 31 Västra Frölunda
Phone: +46 (0)31 773 97 00
www.sove.se

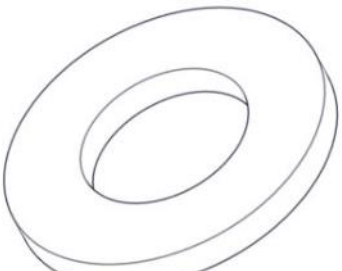
Boltepakker for / Boltpackage for / Bultpaket för		Sign. _____.		
Workout rør Ø 44 L=1270 0gr 07-200-155K	Navn	Artnr/dimensjon	Ant	Lev
	Workout rør Ø 44 L=1270 1 hull Grønn	07-200-155	1	
	Beslag 0gr L=200 3x hull	07-150-028	2	
	Brikke 200 3xM8	04-060-201	2	
	Torx M8x35	04-000-035	6	
	Skive M8	04-050-008	6	

Montering av lekeapparatet / Assembly instructions / Montering av lekredskapet



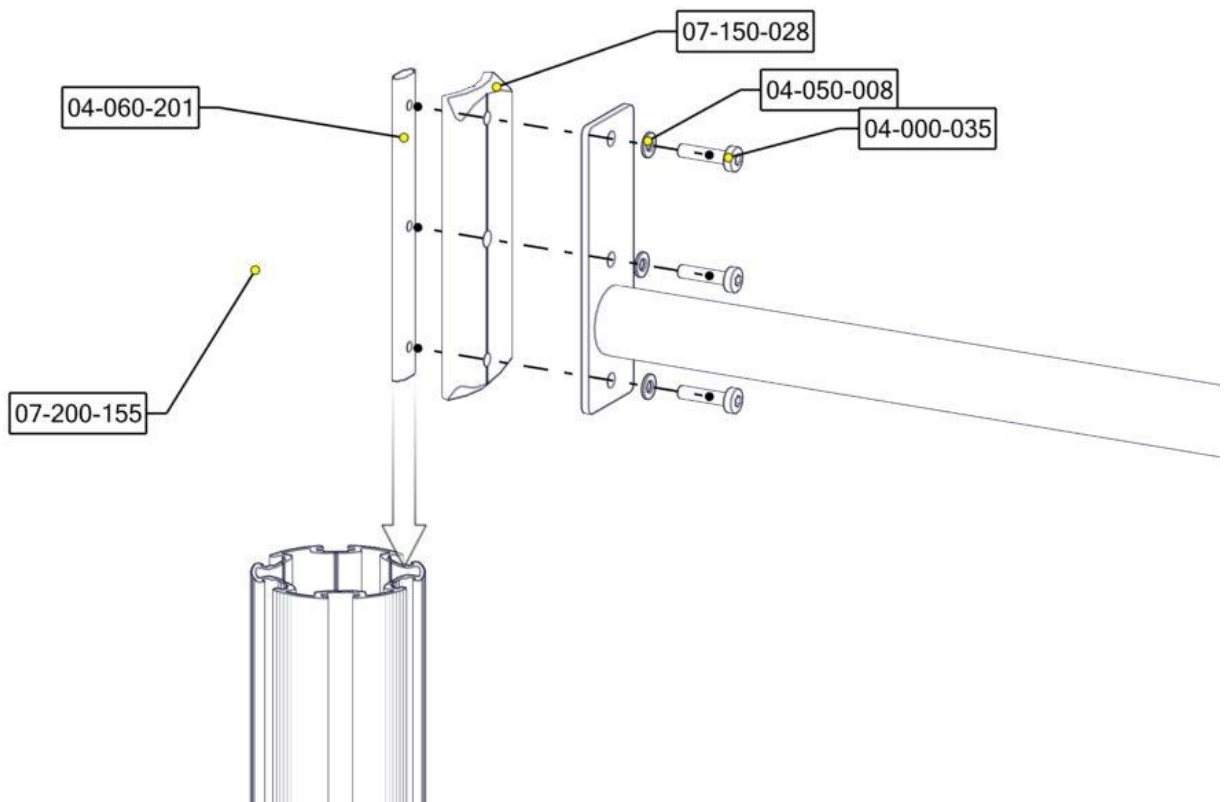

Se på hovedmontering for posisjon
 Look at main assembly for position
 Titta på hovudmontering för position

nr	PartName	Artnr	Antall
1	Beslag 0gr 200 3 hull for workout	07-150-028	2
5	Brikke 200 3XM8	04-060-201	2
2	Skive M8	04-050-008	6
3	Torx M8x35	04-000-035	6
4	Workout_ror44 L=1400 med hull	07-200-155	1

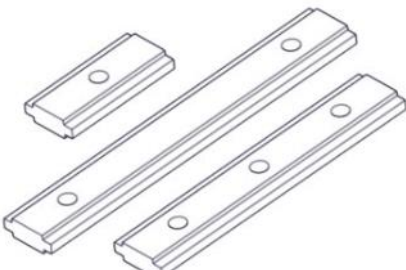

Boltepakker for / Boltpackage for / Bultpaket för

Sign. _____

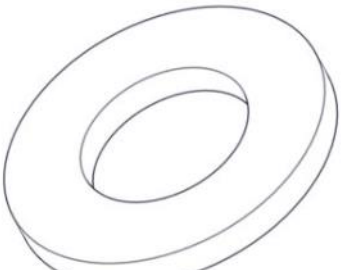
Workout rør Ø 44 L=1270 0gr 07-200-155K	Navn	Artnr/dimensjon	Ant	Lev
	Workout rør Ø 44 L=1270 1 hull Grønn	07-200-155	1	
	Beslag 0gr L=200 3x hull	07-150-028	2	
	Brikke 200 3xM8	04-060-201	2	
	Torx M8x35	04-000-035	6	
	Skive M8	04-050-008	6	