

N**Monteringsanvisning****EN****Assembly Instructions****S****Monteringsanvisning**

Produkt nr. / Product no. / Produkt nr.

07-200-185K**Sort**

Ord. nr. _____

Dato. _____

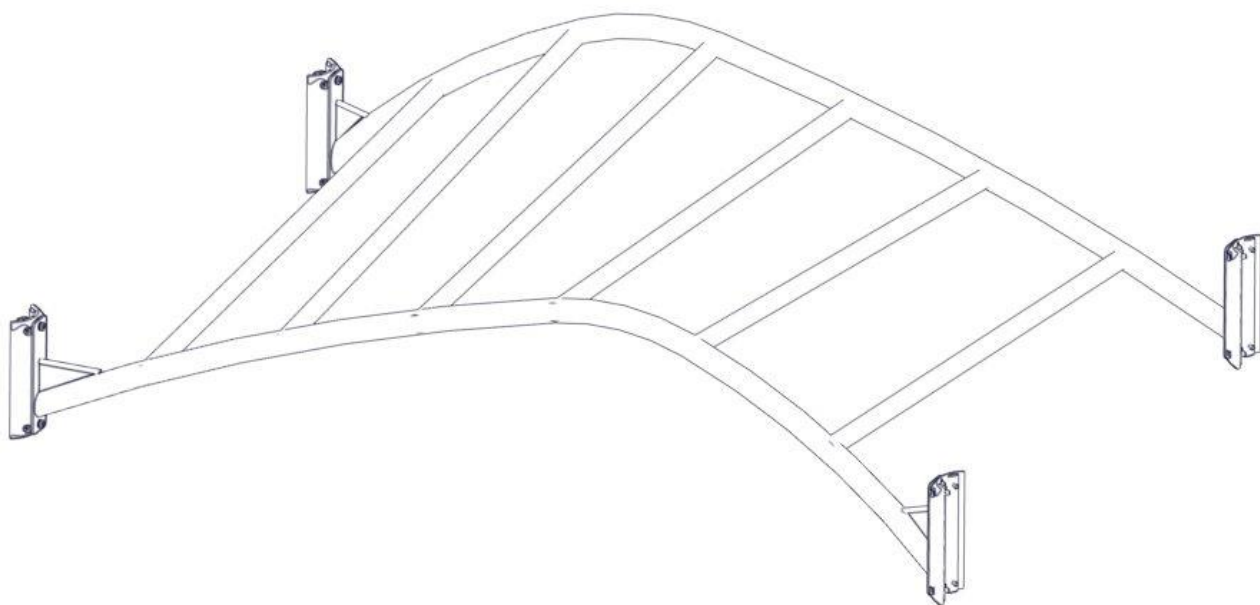

Sign. _____



Søve AS
Grønnvoldveien 290
3830 Ulefoss - Norway
Tlf: +47 35 94 65 65
www.sove.no

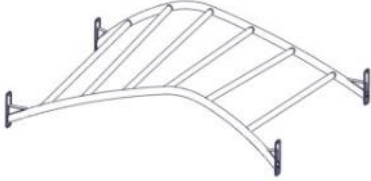
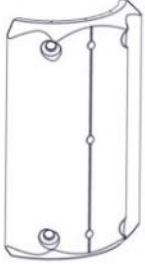
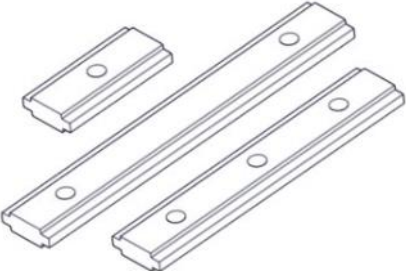

Søve AB
EA Rosengrensgatan 32
421 31 Västra Frölunda
Phone: +46 (0)31 773 97 00
www.sove.se

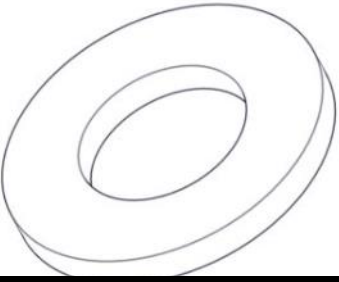
Boltepakker for / Boltpackage for / Bultpaket för		Sign. _____		
Workout brua cc1400 Ø44/38 L=2160	Navn	Artnr/dimensjon	Ant	Lev
	Vridd Armgang brua cc1400 Ø44/38 L=2160 Sort	07-200-185	1	
	Beslag 30gr L=250 4x hull 3 gjenge	07-150-052	4	
	Brikke 250 2xM8	04-060-250	8	
	Torx M8x25	04-000-025	24	
	Skive M8	04-050-008	8	

Montering av lekeapparatet / Assembly instructions / Montering av lekredskapet

Se på hovedmontering for posisjon
 Look at main assembly for position
 Titta på hovudmontering för position

4X

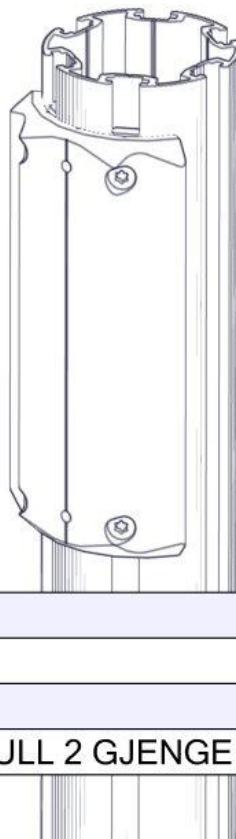

Part Name	Article nr.	Qty
Torx M8x25	04-000-025	4
Brikke 250 2xM8	04-060-250	2
BESLAG 30 GR L=250 4 HULL 2 GJENGE	07-150-052	1

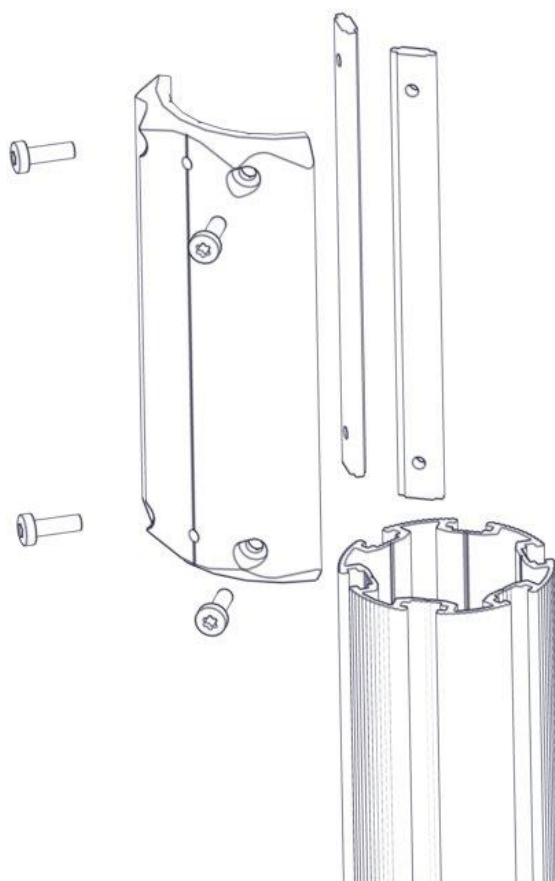

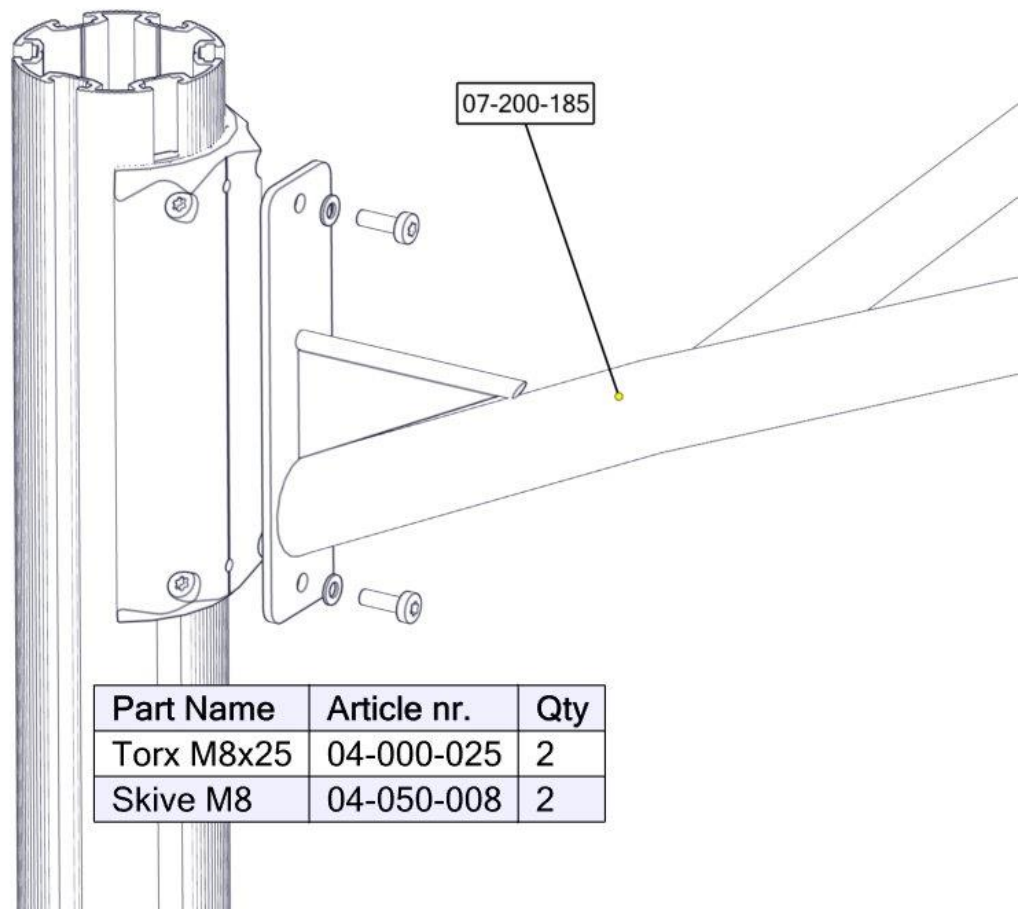

Montering av lekeapparatet / Assembly instructions / Montering av lekredskapet

4X

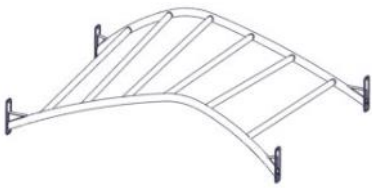
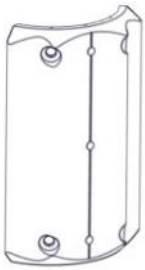
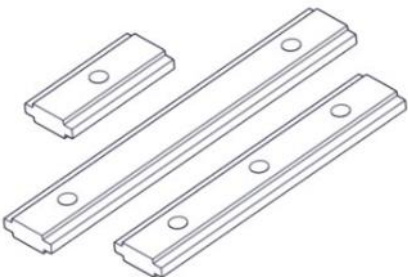

Part Name	Article nr.	Qty
Torx M8x25	04-000-025	2
Skive M8	04-050-008	2

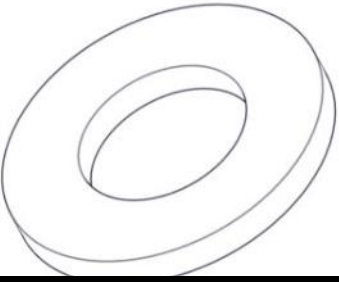
Boltepakker for / Boltpackage for / Bultpaket för		Sign. _____		
Workout brua cc1400 Ø44/38 L=2160	Navn	Artnr/dimensjon	Ant	Lev
	Vridd Armgang brua cc1400 Ø44/38 L=2160 Sort	07-200-185	1	
	Beslag 30gr L=250 4x hull 3 gjenge	07-150-052	4	
	Brikke 250 2xM8	04-060-250	8	
	Torx M8x25	04-000-025	24	
	Skive M8	04-050-008	8	