

**Monteringsanvisning****Assembly Instructions****Monteringsanvisning**

Produkt nr. / Product no. / Produkt nr.

07-200-191K**Grønn**

Ord. nr. _____

Dato. _____

Sign. _____

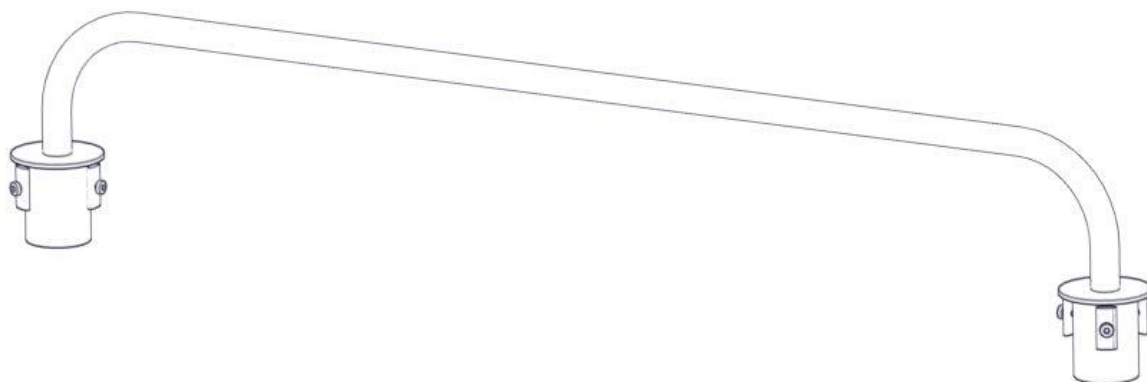
**søve**



Søve AS
Grønnvoldveien 290
3830 Ulefoss - Norway
Tlf: +47 35 94 65 65
www.sove.no

**søve**

Søve AB
EA Rosengrensgatan 32
421 31 Västra Frölunda
Phone: +46 (0)31 773 97 00
www.sove.se

Boltepakker for / Boltpackage for / Bultpaket för

Sign. _____

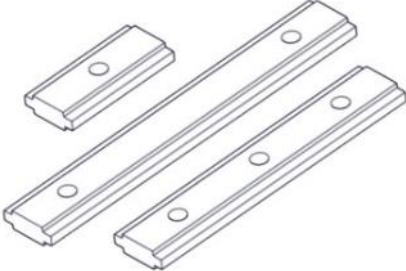

Hopp over/ under 07-200-191K	Navn	Artnr/dimensjon	Ant	Lev
	Hopp over/under cc1400 grønn	07-200-191	1	
	Torx M8x12	04-000-012	6	
	Brikke 50 1xM8	04-060-050	6	

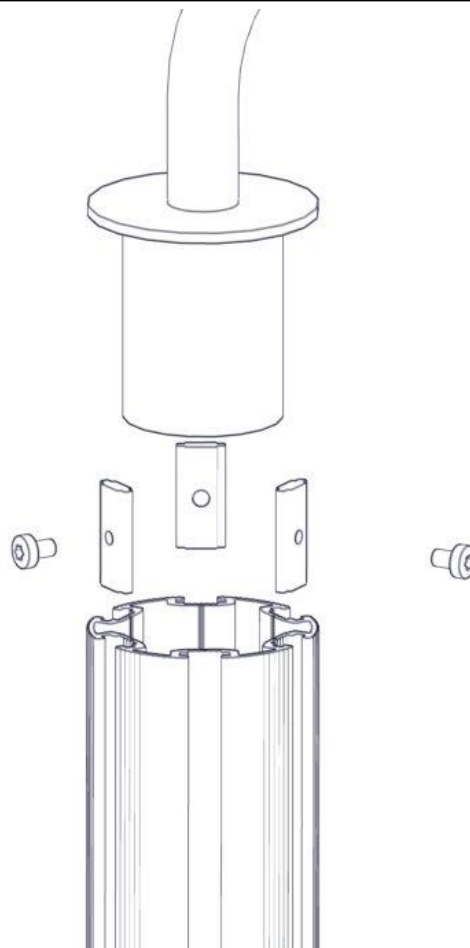
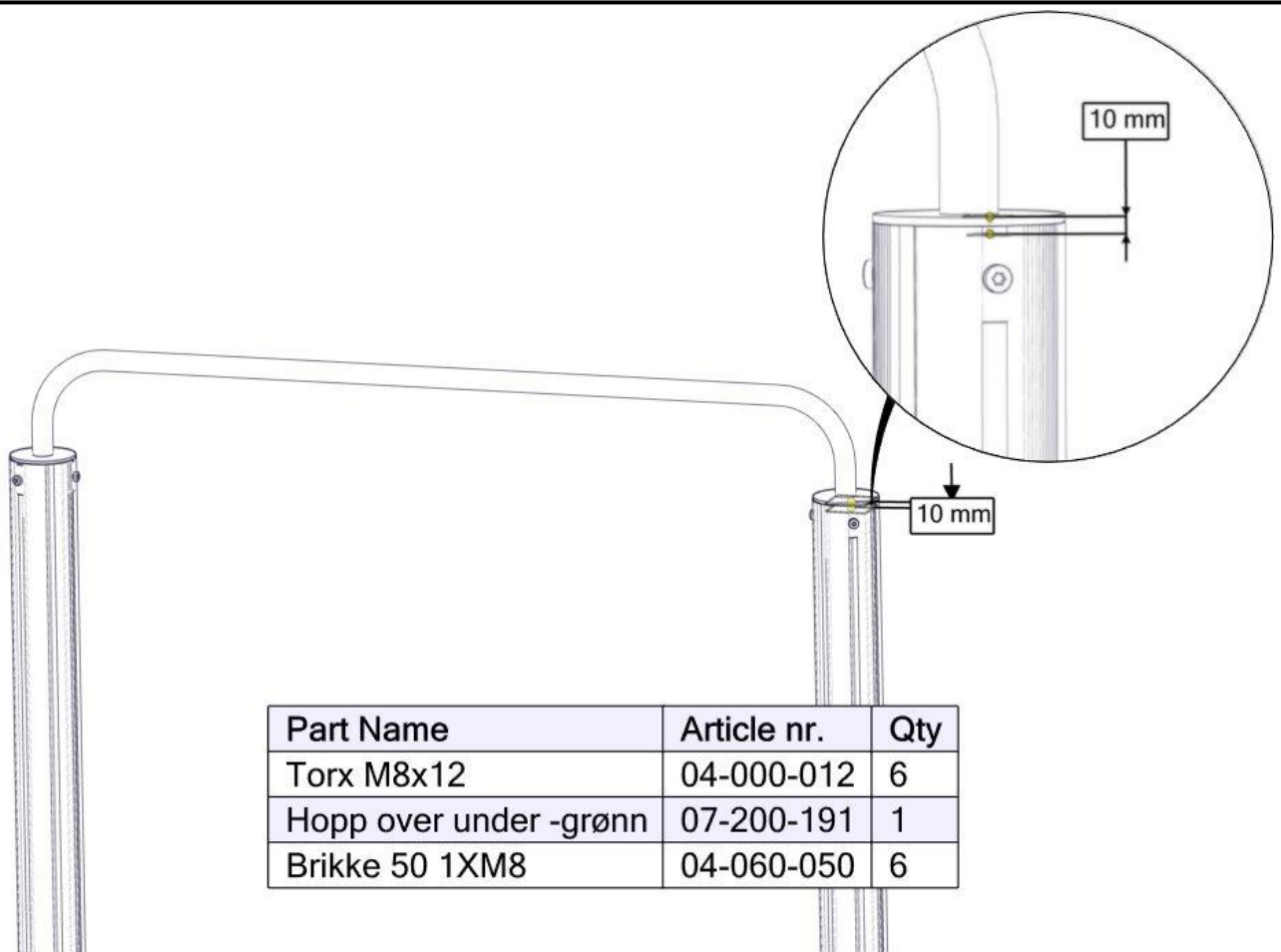
Montering av lekeapparatet / Assembly instructions / Montering av lekredskapet



Boltepakker for / Boltpackage for / Bultpaket för

Sign. _____

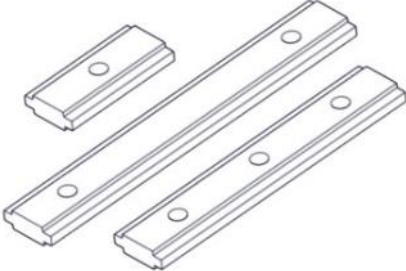
Hopp over/ under 07-200-191K	Navn	Artnr/dimensjon	Ant	Lev
	Hopp over/under cc1400 grønn	07-200-191	1	
	Torx M8x12	04-000-012	6	
	Brikke 50 1xM8	04-060-050	6	