

N

Monteringsanvisning

EN

Assembly Instructions

S

Monteringsanvisning

Produkt nr. / Product no. / Produkt nr.

07-300-191K**Grå**

Ord. nr. _____

Dato. _____

Sign. _____

**søve**





Søve AS
Grønnvoldveien 290
3830 Ulefoss - Norway
Tlf: +47 35 94 65 65
www.sove.no

**søve**

Søve AB
EA Rosengrensgatan 32
421 31 Västra Frölunda
Phone: +46 (0)31 773 97 00
www.sove.se

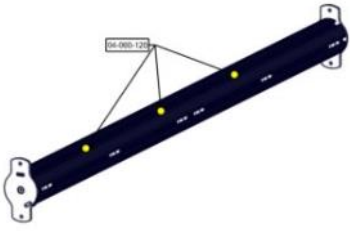
Boltepakker for / Boltpackage for / Bultpaket för

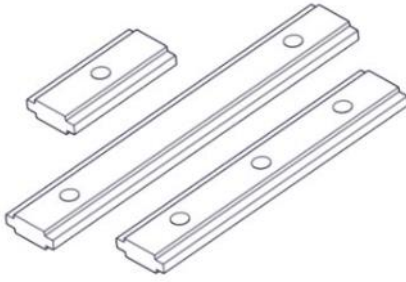
Sign. _____

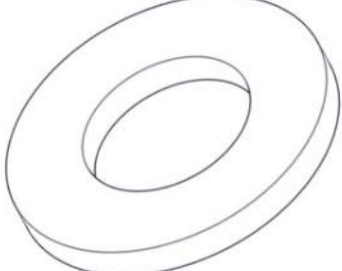
Drager B+ C + klatrevegg 07-300-191K	Navn	Artnr/dimensjon	Ant	Lev
	Drager B Grå	07-300-191	1	
	Drager C Grå	07-300-192	3	
	Beslag 0gr L=200 2xhull	07-150-023	8	
	Brikke 200 2xM8	04-060-200	8	
	Torx M8x30 Torx M8x35	04-000-030 04-000-035	24 16	
	Skive M8	04-050-008	16	

Boltepakker for / Boltpackage for / Bultpaket för

Sign. _____.

Drager B+ C + klatrevegg 07-300-191K	Navn	Artnr/dimensjon	Ant	Lev
	Klatrevegg 915x2500 til 14-101-020 Grå	07-300-121	2	

Montering av lekeapparatet / Assembly instructions / Montering av lekredskapet

Drager B

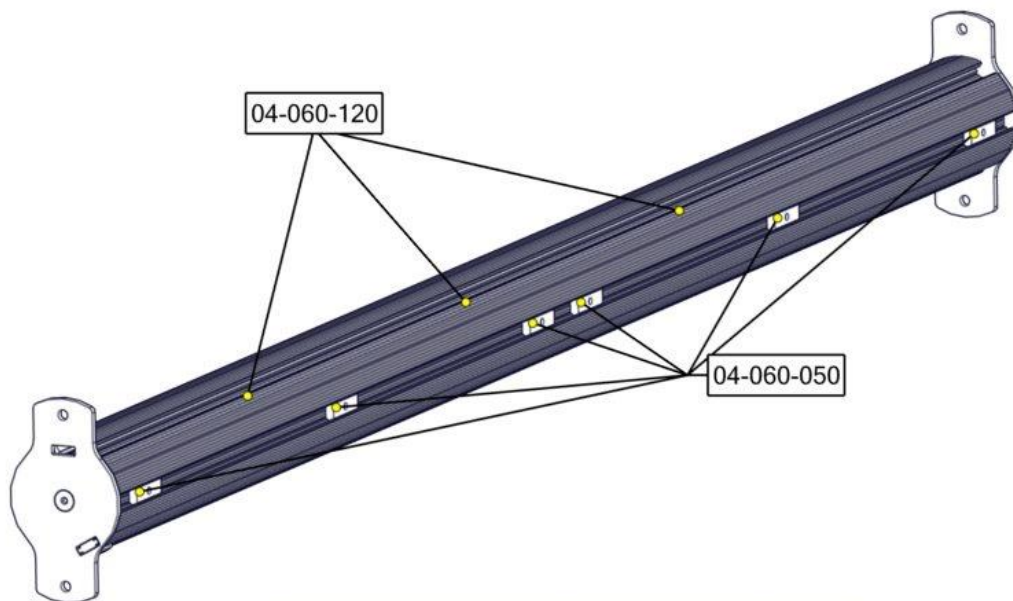

Part Name	Article nr.	Qty
Brikke 120 3xM8	04-060-120	3
Brikke 50 1xM8	04-060-050	6

Drager B

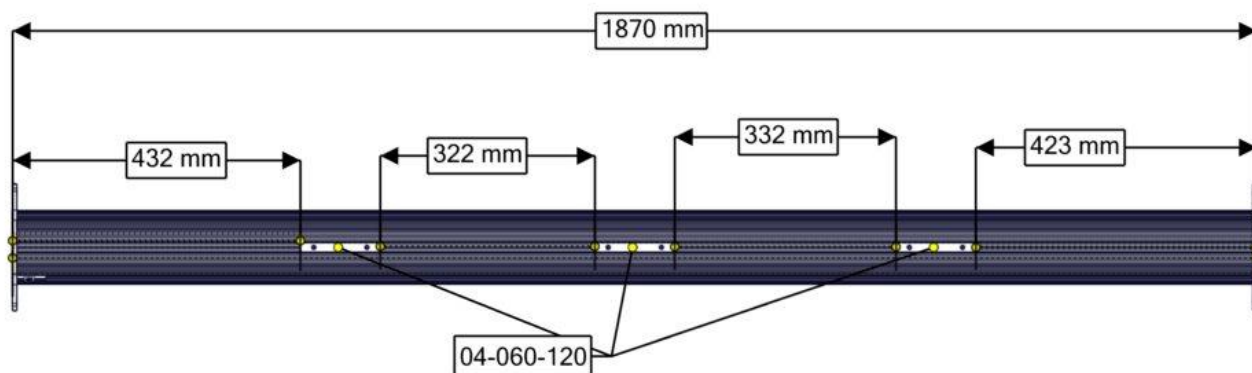

Montering av lekeapparatet / Assembly instructions / Montering av lekredskapet

Drager C



Part Name	Article nr.	Qty
Brikke 50 1XM8	04-060-050	6

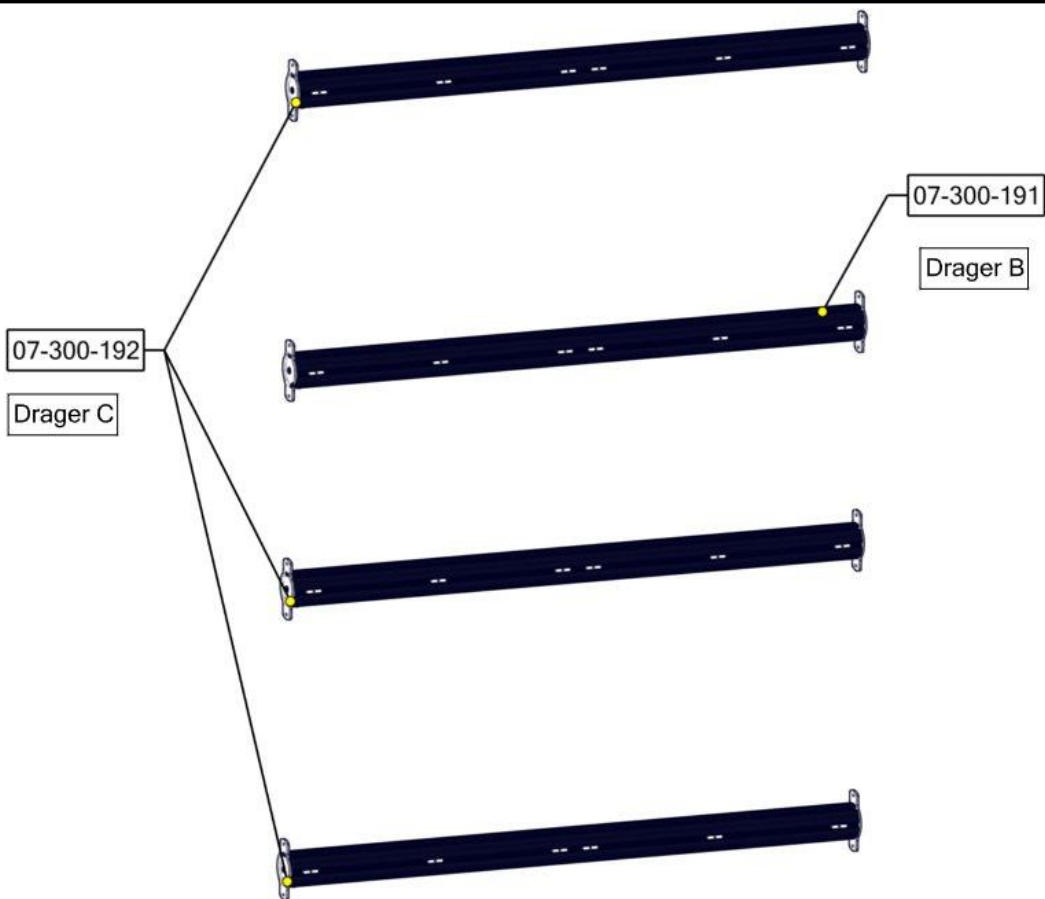

Montering av lekeapparatet / Assembly instructions / Montering av lekredskapet

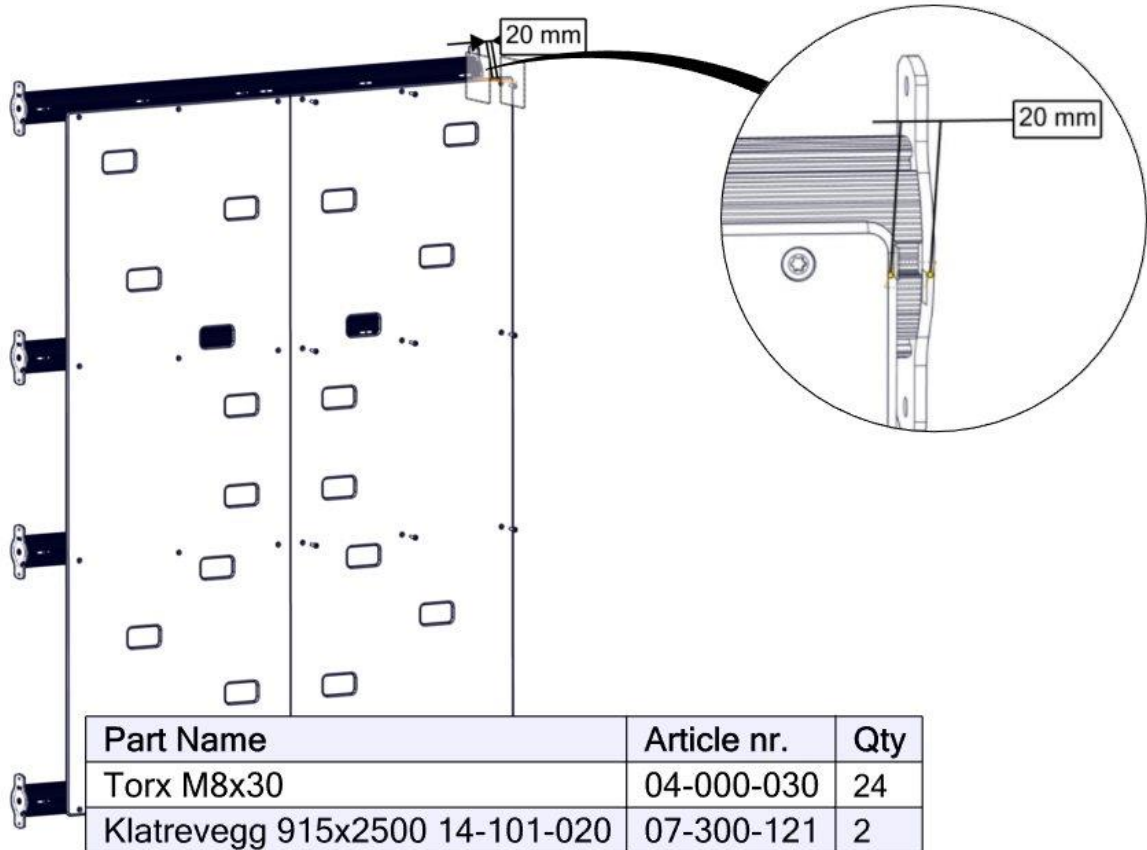

Se på hovedmontering for posisjon
 Look at main assembly for position
 Titta på hovudmontering för position

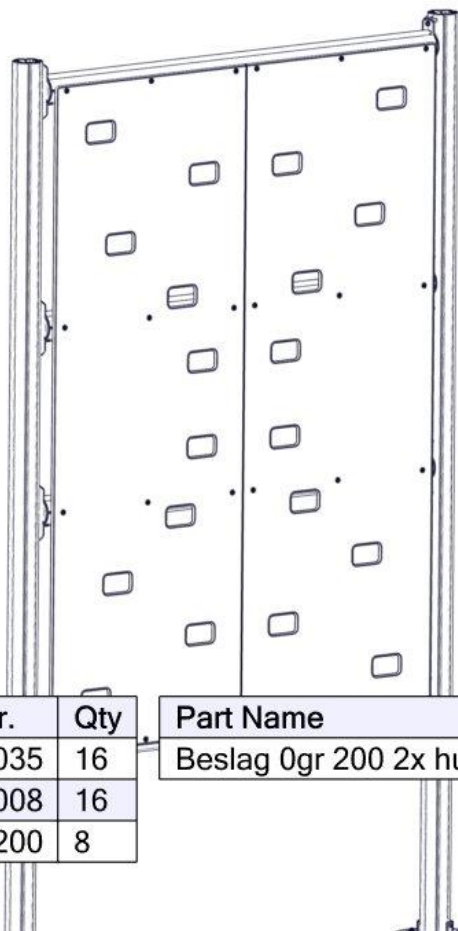

Part Name	Article nr.	Qty
Torx M8x35	04-000-035	16
Skive M8	04-050-008	16
Brikke 200 2xM8	04-060-200	8



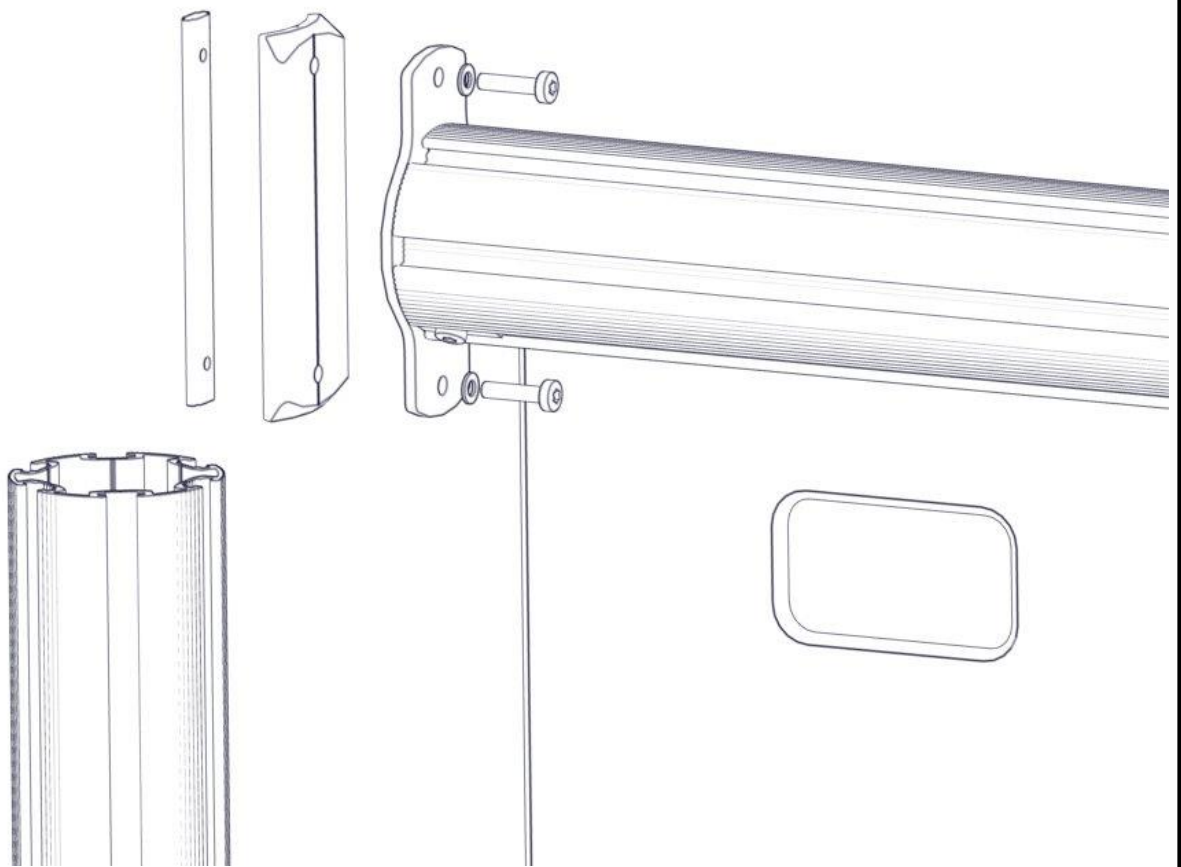

Part Name	Article nr.	Qty
Beslag 0gr 200 2x hull	07-150-023	8

Montering av lekeapparatet / Assembly instructions / Montering av lekredskapet

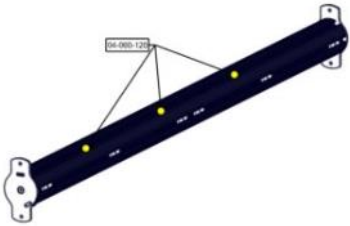

Boltepakker for / Boltpackage for / Bultpaket för

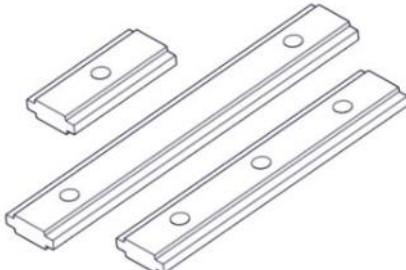
Sign. _____

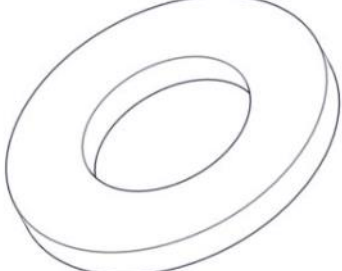
Drager B+ C + klatrevegg 07-300-191K	Navn	Artnr/dimensjon	Ant	Lev
	Drager B Grå	07-300-191	1	
	Drager C Grå	07-300-192	3	
	Beslag 0gr L=200 2xhull	07-150-023	8	
	Brikke 200 2xM8	04-060-200	8	
	Torx M8x30 Torx M8x35	04-000-030 04-000-035	24 16	
	Skive M8	04-050-008	16	

Boltepakker for / Boltpackage for / Bultpaket för

Sign. _____.

Drager B+ C + klatrevegg 07-300-191K	Navn	Artnr/dimensjon	Ant	Lev
	Klatrevegg 915x2500 til 14-101-020 Grå	07-300-121	2	