

N

**Monteringsanvisning**

EN

**Assembly Instructions**

S

**Monteringsanvisning**

Produkt nr. / Product no. / Produkt nr.

**07-300-410K****Blå / Pistasj**

Ord. nr. \_\_\_\_\_

Dato. \_\_\_\_\_

Sign. \_\_\_\_\_

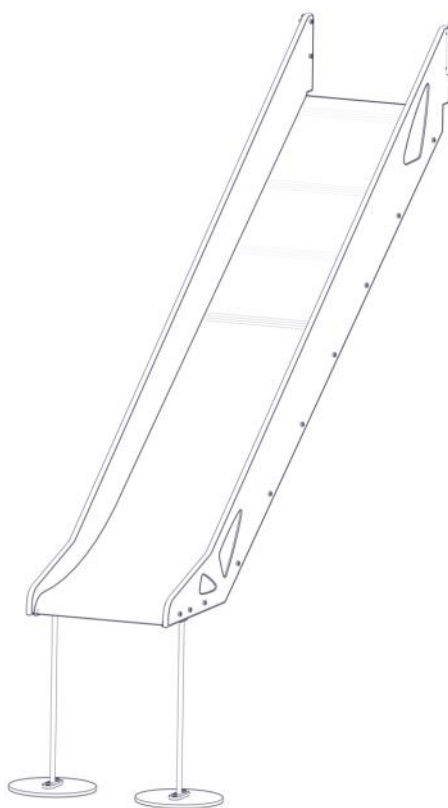





Søve AS  
Grønnvoldveien 290  
3830 Ulefoss - Norway  
Tlf: +47 35 94 65 65  
[www.sove.no](http://www.sove.no)

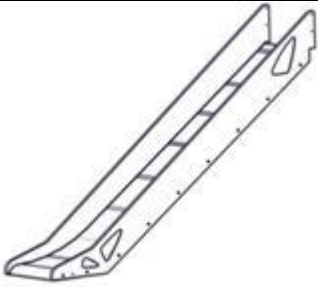
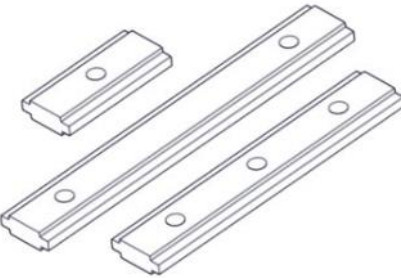

Søve AB  
EA Rosengrensgatan 32  
421 31 Västra Frölunda  
Phone: +46 (0)31 773 97 00  
[www.sove.se](http://www.sove.se)

**Boltepakker for / Boltpackage for / Bultpaket för**

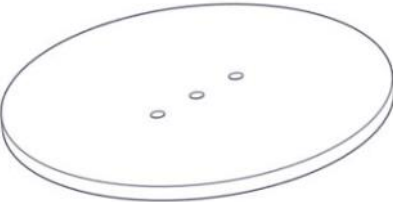
Sign. \_\_\_\_\_

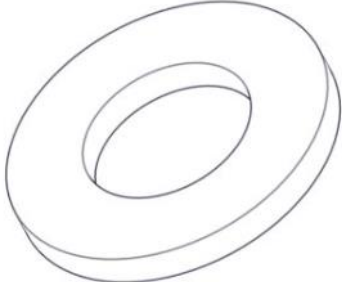
| Rutsjebane 1,4m blå/pistasj<br>07-300-410K  | Navn                                   | Artnr/<br>dimensjon                    | Ant         | Lev |
|---|--|--|-------------|-----|
|    | Rutsjebane<br>H=1,4m<br>Blå / Pistasj  | 07-300-410                             | 1           |     |
|    | Brikke 160 3xM8                        | 04-060-160                             | 2           |     |
|   | Torx M8x35<br>Torx M8x40<br>Torx M8x45 | 04-000-035<br>04-000-040<br>04-000-045 | 4<br>4<br>2 |     |
|  | Fundament skive                        | 00-003-103                             | 2           |     |
|  | Stålforankring<br>L=600                | 00-100-316                             | 2           |     |
|  | Skive M8                               | 04-050-008                             | 10          |     |

**Boltepakker for / Boltpackage for / Bultpaket för**

Sign. \_\_\_\_\_.

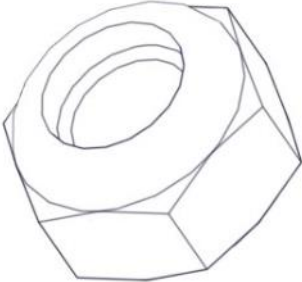
| Rutsjebane 1,4m blå/pistasj<br>07-300-410K  | Navn          | Artnr/<br>dimensjon | Ant | Lev |
|---|---------------|---------------------|-----|-----|
|  | Låsemutter M8 | 04-040-008          | 6   |     |
|   |               |                     |     |     |
|   |               |                     |     |     |
|   |               |                     |     |     |
|   |               |                     |     |     |
|   |               |                     |     |     |
|   |               |                     |     |     |

## Montering av lekeapparatet / Assembly instructions / Montering av lekredskapet



| nr | PartName             | Artnr      | Antall |
|----|----------------------|------------|--------|
| 1  | Fundament plate      | 00-003-103 | 2      |
| 2  | Stålforankring L=600 | 00-100-316 | 2      |
| 3  | Torx M8x35           | 04-000-035 | 4      |

| nr | PartName      | Artnr      | Antall |
|----|---------------|------------|--------|
| 4  | Låsemutter M8 | 04-040-008 | 4      |
| 5  | Skive M8      | 04-050-008 | 8      |

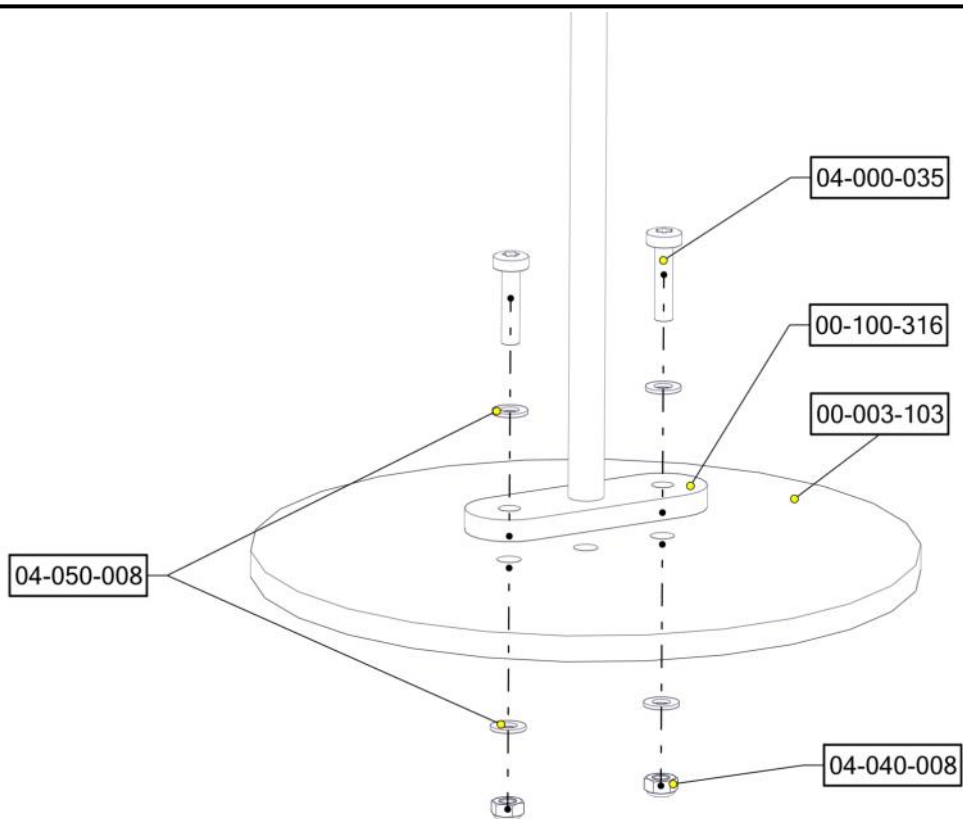

## Montering av lekeapparatet / Assembly instructions / Montering av lekredskapet



| nr | PartName      | Artnr      | Antall |
|----|---------------|------------|--------|
| 1  | Torx M8x50    | 04-000-050 | 2      |
| 2  | Låsemutter M8 | 04-040-008 | 2      |
| 3  | Skive M8      | 04-050-008 | 2      |

| nr | PartName        | Artnr      | Antall |
|----|-----------------|------------|--------|
| 4  | Rustjebane H1.4 | 07-300-410 | 1      |

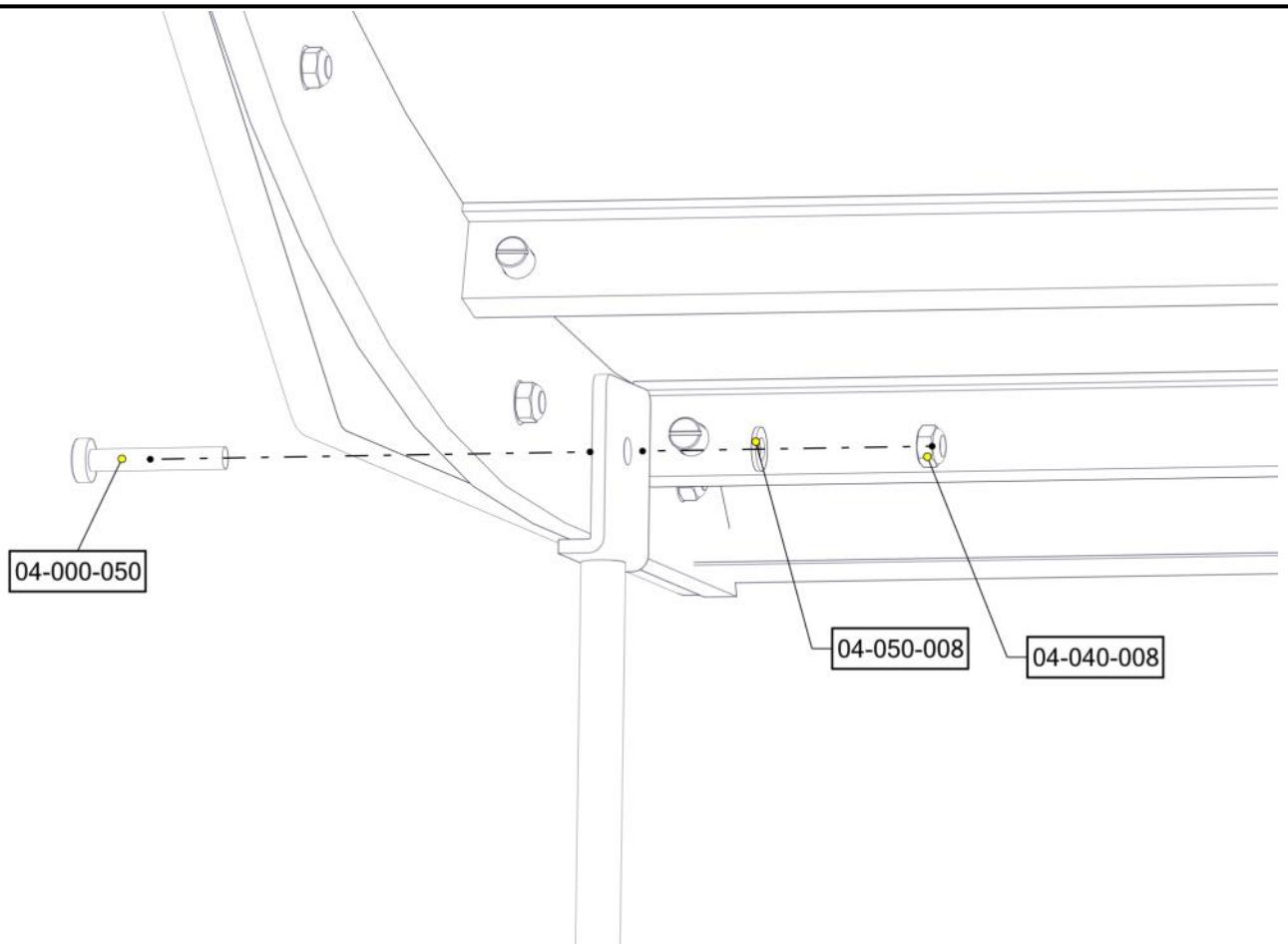

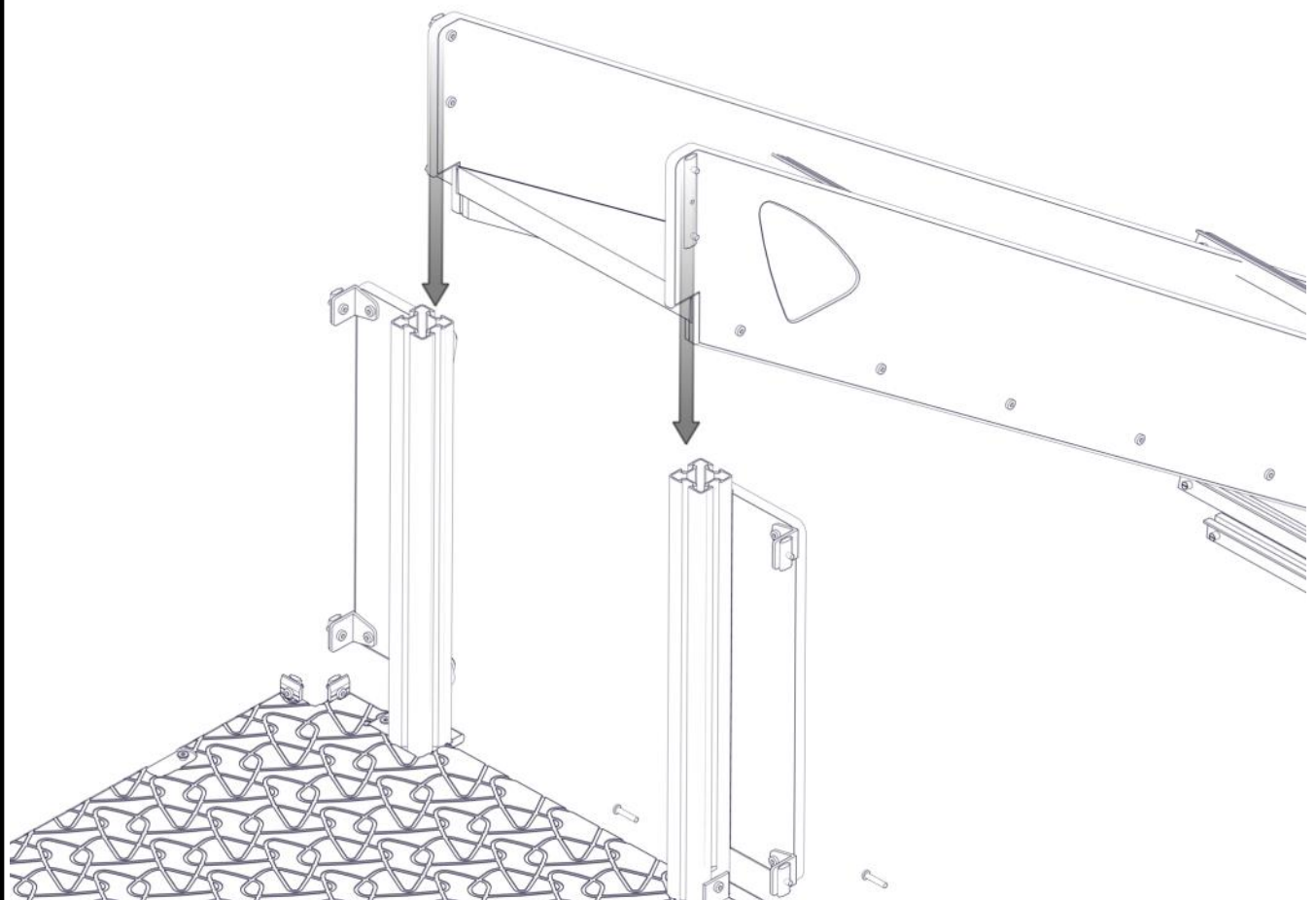
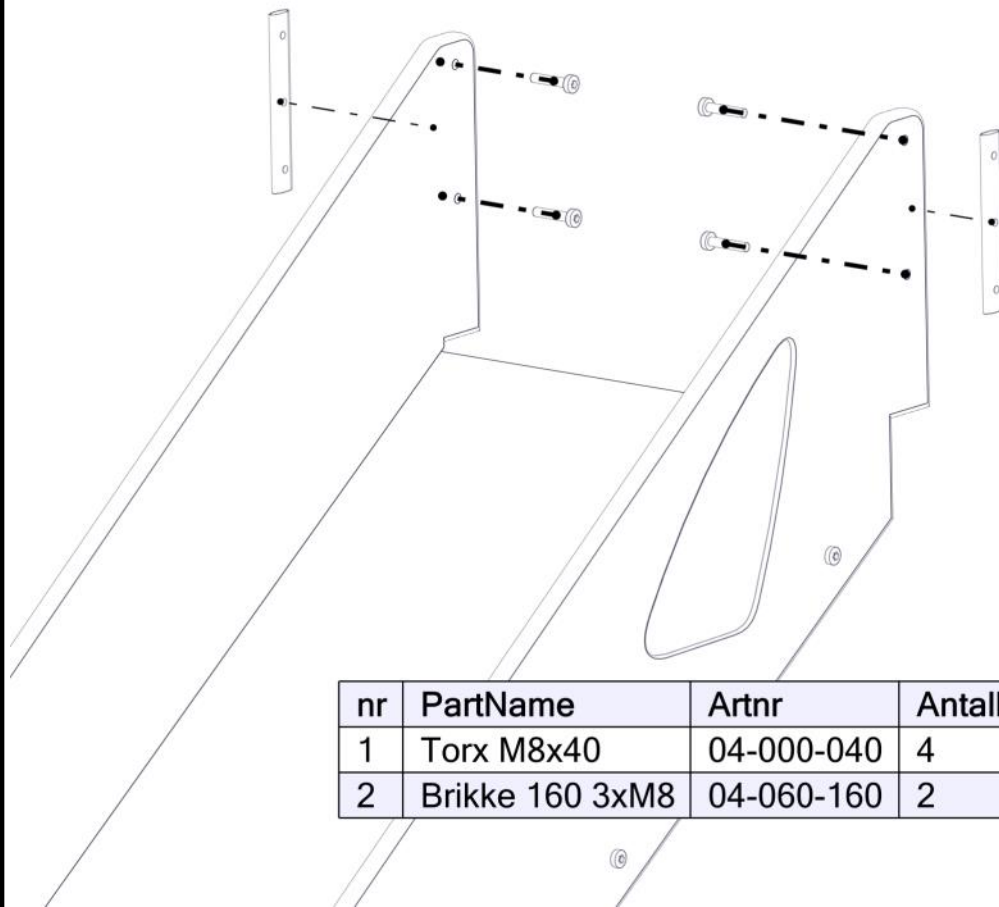
**Montering av lekeapparatet / Assembly instructions / Montering av lekredskapet**

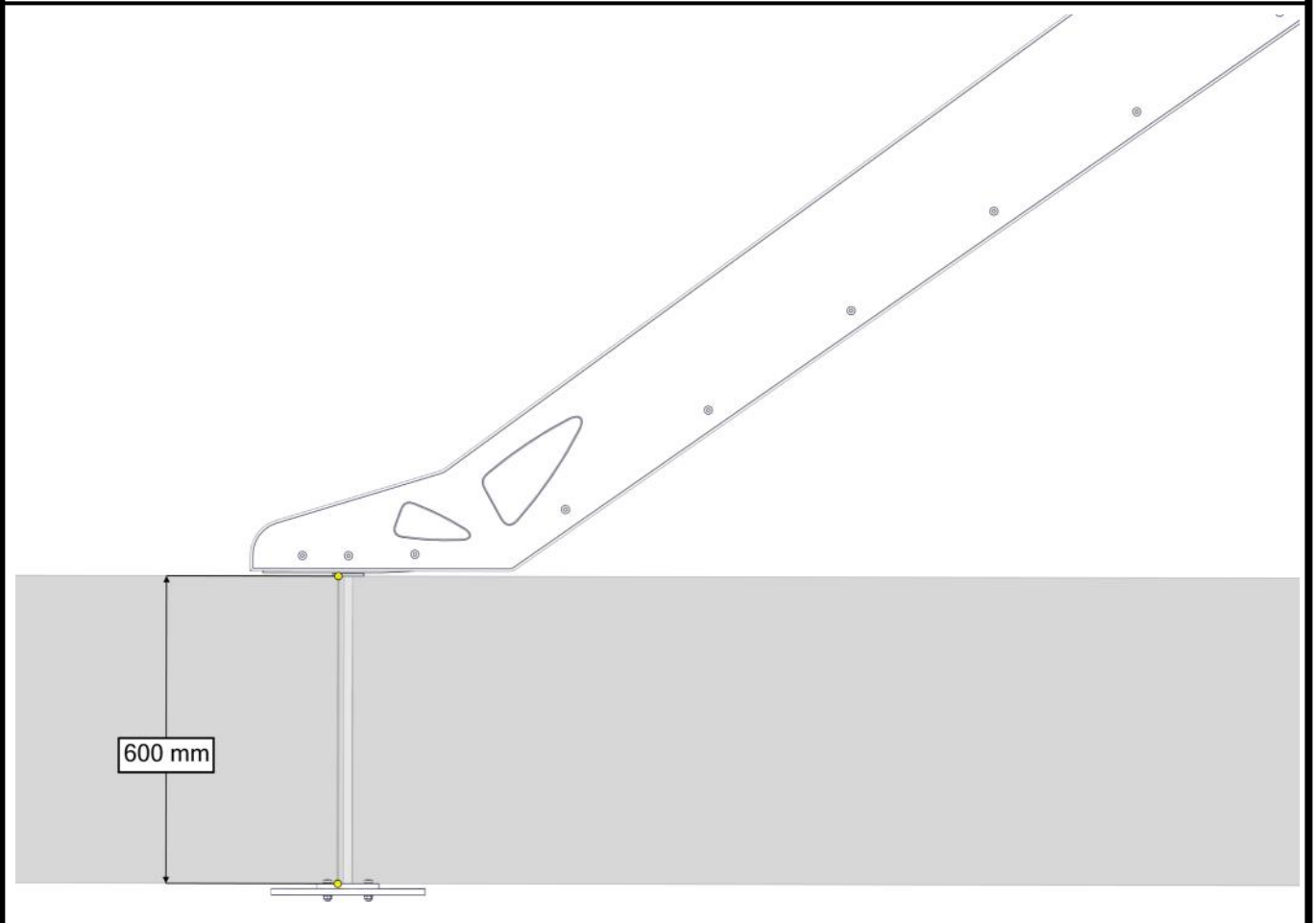
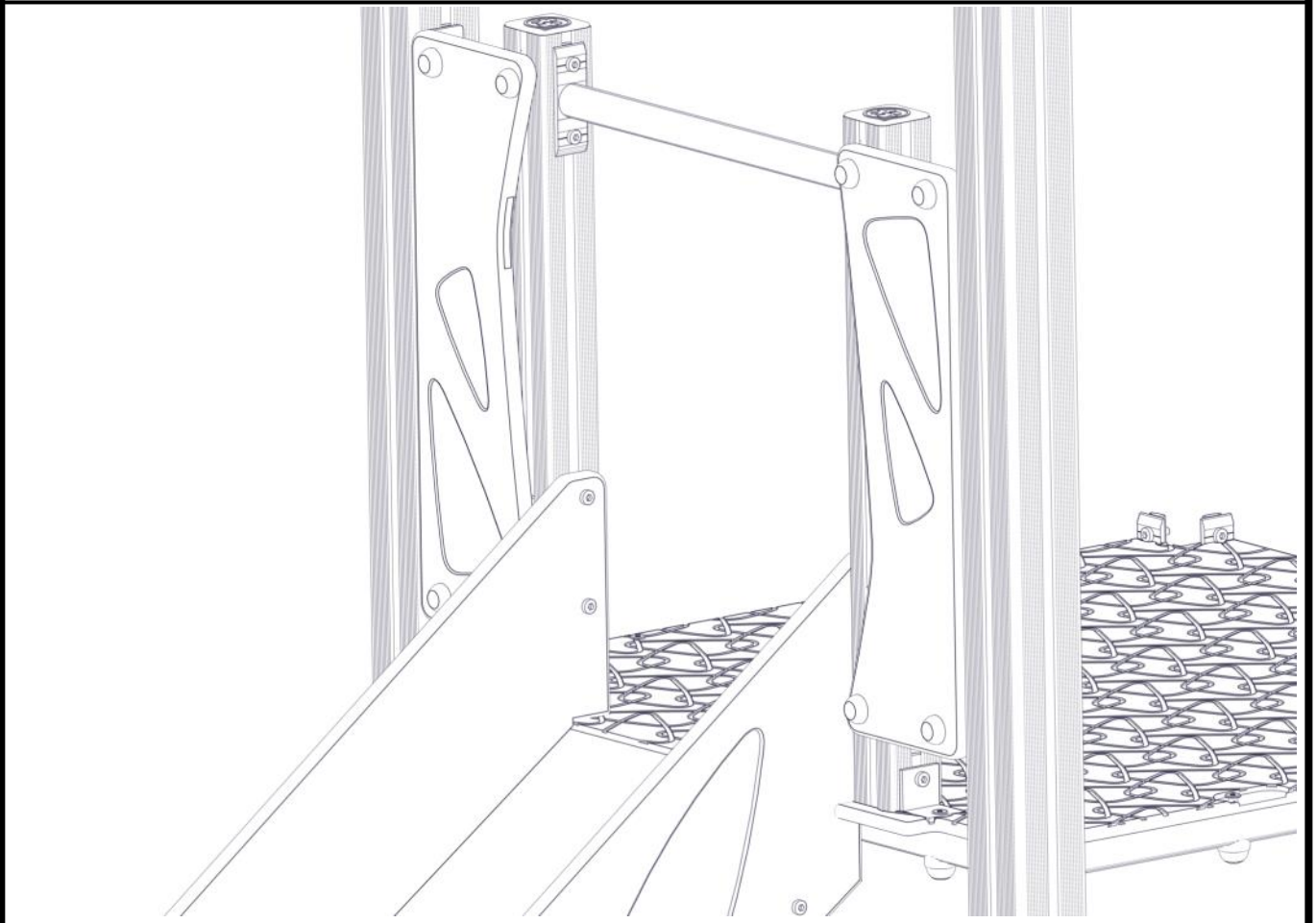



**Montering av lekeapparatet / Assembly instructions / Montering av lekredskapet**



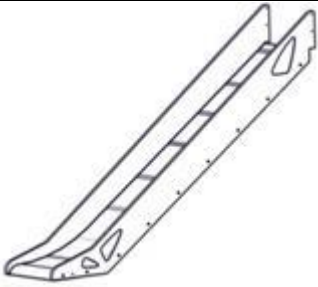
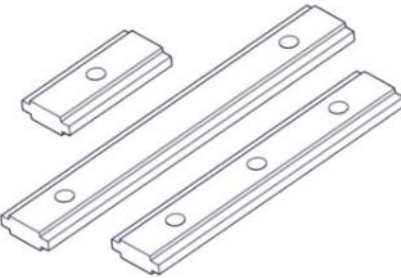

**Boltepakker for / Boltpackage for / Bultpaket för**

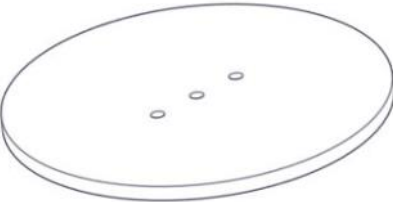
Sign. \_\_\_\_\_

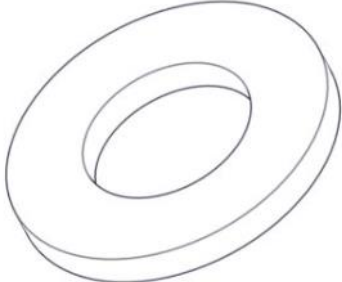
| Rutsjebane 1,4m blå/pistasj<br>07-300-410K  | Navn                                   | Artnr/<br>dimensjon                    | Ant         | Lev |
|---|--|--|-------------|-----|
|    | Rutsjebane<br>H=1,4m<br>Blå / Pistasj  | 07-300-410                             | 1           |     |
|    | Brikke 160 3xM8                        | 04-060-160                             | 2           |     |
|   | Torx M8x35<br>Torx M8x40<br>Torx M8x45 | 04-000-035<br>04-000-040<br>04-000-045 | 4<br>4<br>2 |     |
|  | Fundament skive                        | 00-003-103                             | 2           |     |
|  | Stålforankring<br>L=600                | 00-100-316                             | 2           |     |
|  | Skive M8                               | 04-050-008                             | 10          |     |

**Boltepakker for / Boltpackage for / Bultpaket för**

Sign. \_\_\_\_\_.

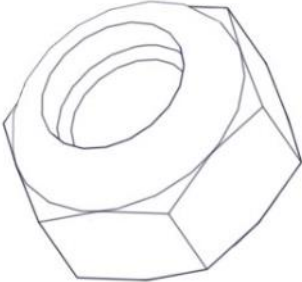
| Rutsjebane 1,4m blå/pistasj<br>07-300-410K  | Navn          | Artnr/<br>dimensjon | Ant | Lev |
|---|---------------|---------------------|-----|-----|
|  | Låsemutter M8 | 04-040-008          | 6   |     |
|   |               |                     |     |     |
|   |               |                     |     |     |
|   |               |                     |     |     |
|   |               |                     |     |     |
|   |               |                     |     |     |
|   |               |                     |     |     |

18.04.2023 MNO  
Forandret lengde av stålforankring til 600mm