

N**Monteringsanvisning****EN****Assembly Instructions****S****Monteringsanvisning**

Produkt nr. / Product no. / Produkt nr.

07-302-043**Rød / Brun**

Ord. nr. _____

Dato. _____



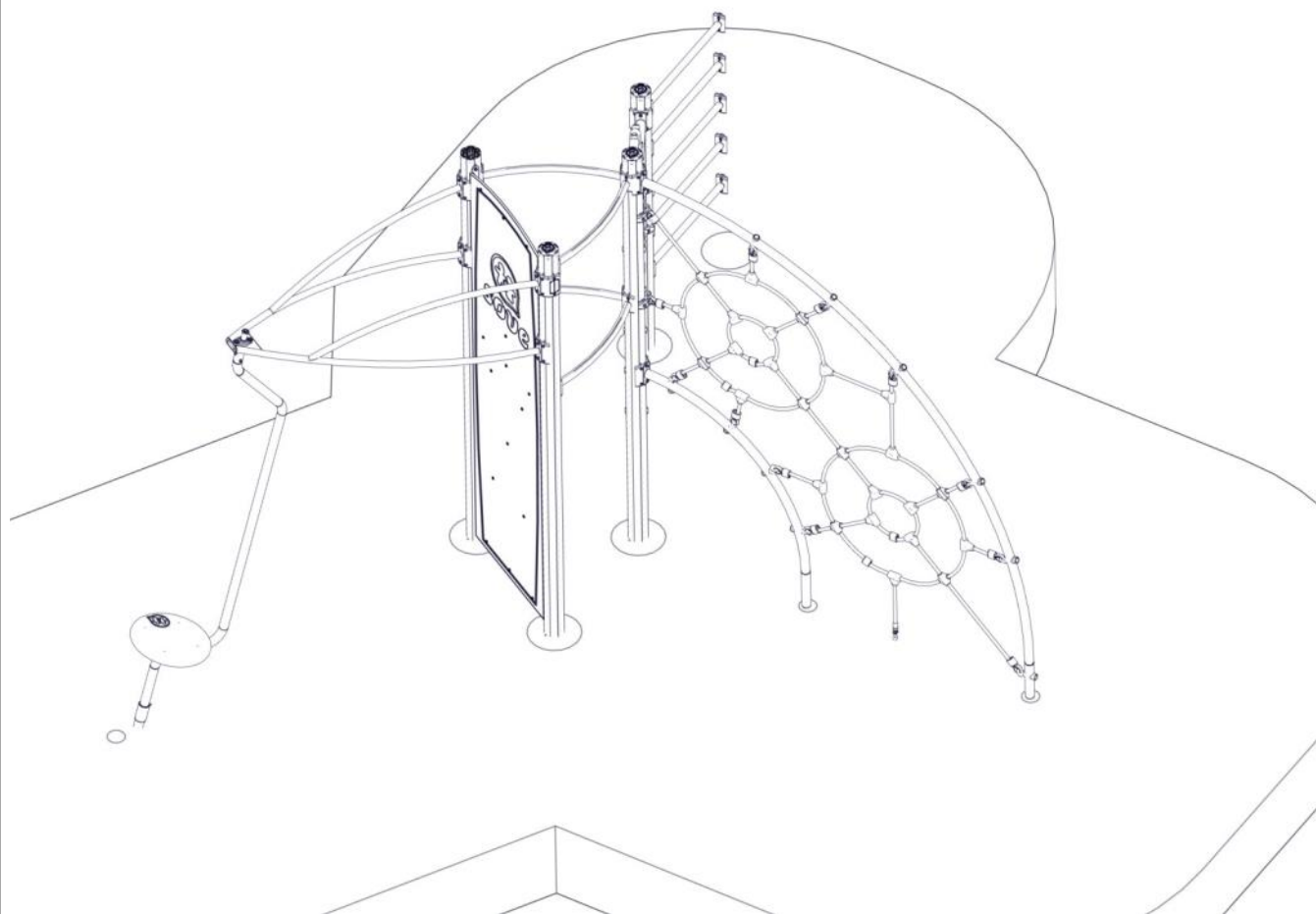

Sign. _____



Søve AS
Grønnvoldveien 290
3830 Ulefoss - Norway
Tlf: +47 35 94 65 65
www.sove.no

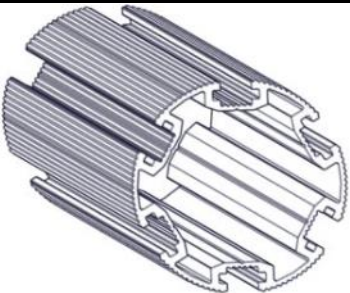

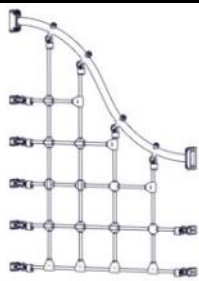

Søve AB
EA Rosengrensgatan 32
421 31 Västra Frölunda
Phone: +46 (0)31 773 97 00
www.sove.se

Boltepakker for / Boltpackage for / Bultpaket för		Sign. _____		
Rød-brun 07-302-043	Navn	Artnr/ dimensjon	Ant	Lev
	Stolpe Ø110 L=3450 (2850-600) Stolpe Ø110 L= 2500 (1900-600) Brun	SFA5126/1 SFA5126/1	3 1	
	Klatreplate/ vegg Søve logo komplett Rød	07-300-110K (Se egen del- montering)	1	
	Sperrerør bøyd uten hull L=750 Rød	07-500-063K (Se egen del- montering)	4	
	S-Nett inkludert beslag og rør Rød	07-500-017K (Se egen del- montering)	1	
	Sperrerør rett uten hull L= 750 Rød	07-500-061K (Se egen del- montering)	5	
	Edderkoppnett dobbel 30Gr Komplett Rød	07-500-019K (Se egen del- montering)	1	

Boltepakker for / Boltpackage for / Bultpaket för

Sign. _____.

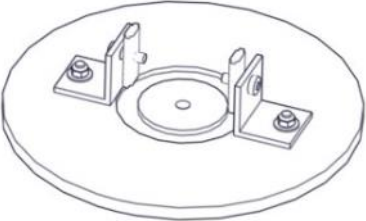
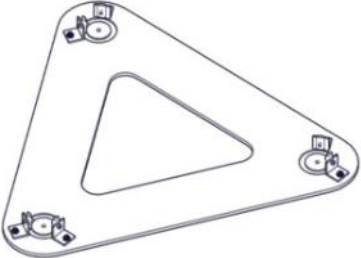
Rød-brun 07-302-043	Navn	Artnr/ dimensjon	Ant	Lev
	Swing komplett CC880 Rød	07-250-000K (Se egen del- montering)	1	
	Endelokk Ø110	00-400-995	4	
	Fundamentplate 1x110 stolpe	07-400-101K (Se egen del- montering)	1	
	Fundamentplate 3x110 stolpe	07-400-103K (Se egen del- montering)	1	

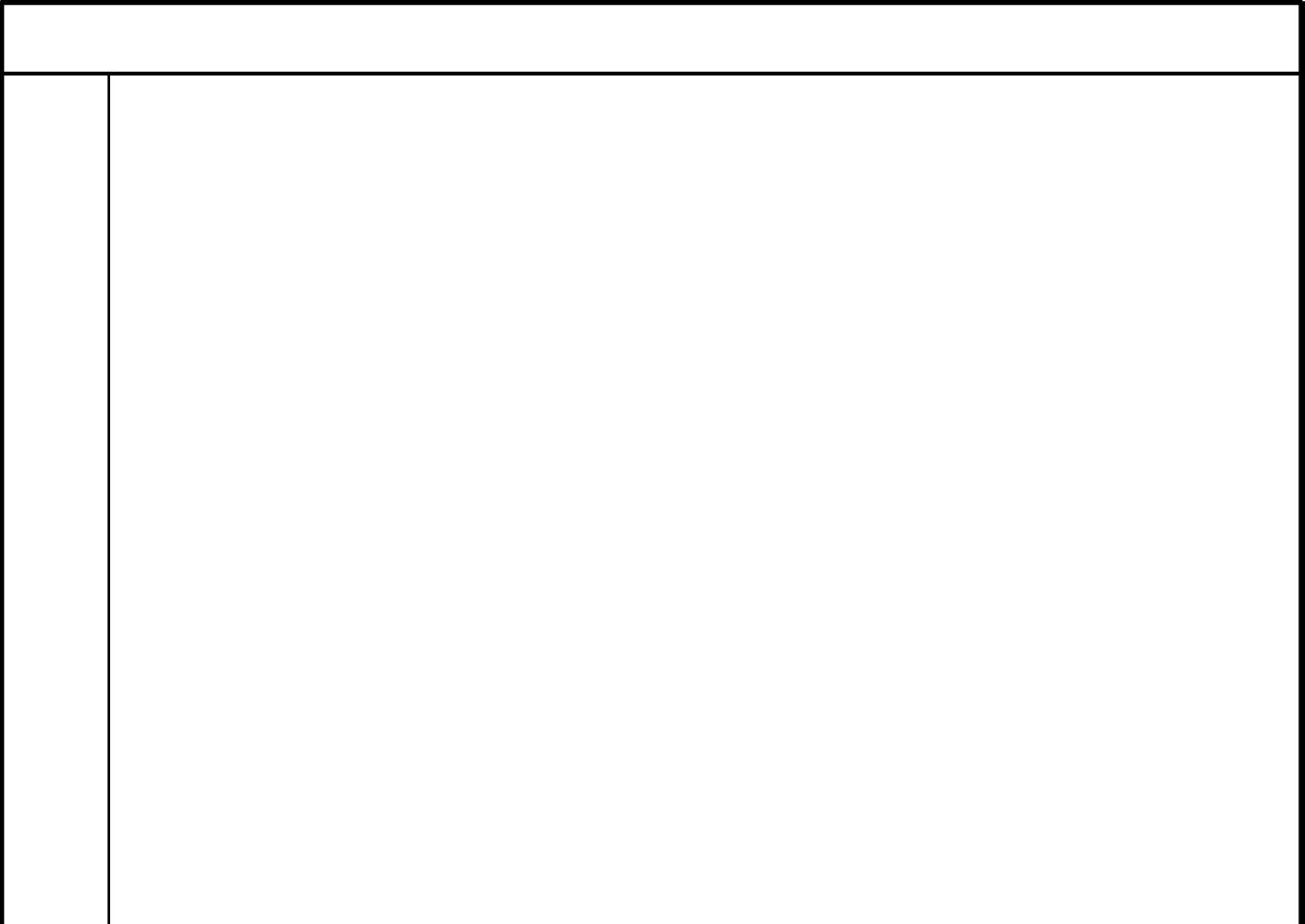

04-000-025

04-000-025

04-000-025

04-000-035

N Bolten skrues HELT igjennom aluminiumen.
Maks moment: 30Nm

EN The bolt must be tightened in to the post, so that it peirces the aluminium
Max torque: 30Nm

S Bulten skruvas HELT ignom aluminiumen.
Maks vridmoment: 30Nm

Se separat delmontering for detaljer
 See separate assembly for details
 Se separata delmontering för detaljer

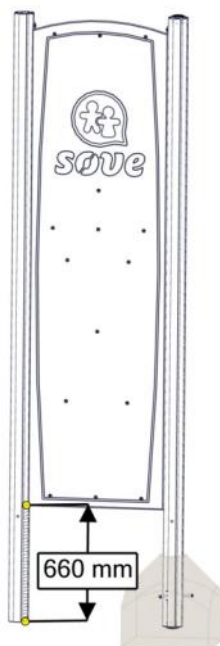

Part Name	Article nr.	Qty
Stolpe Ø110 L=3450 (2850-600)	SFA5126/1	2
Klatreplate/vegg Søve logo komplett	07-300-110K	1

Se separat delmontering for detaljer
 See separate assembly for details
 Se separata delmontering för detaljer

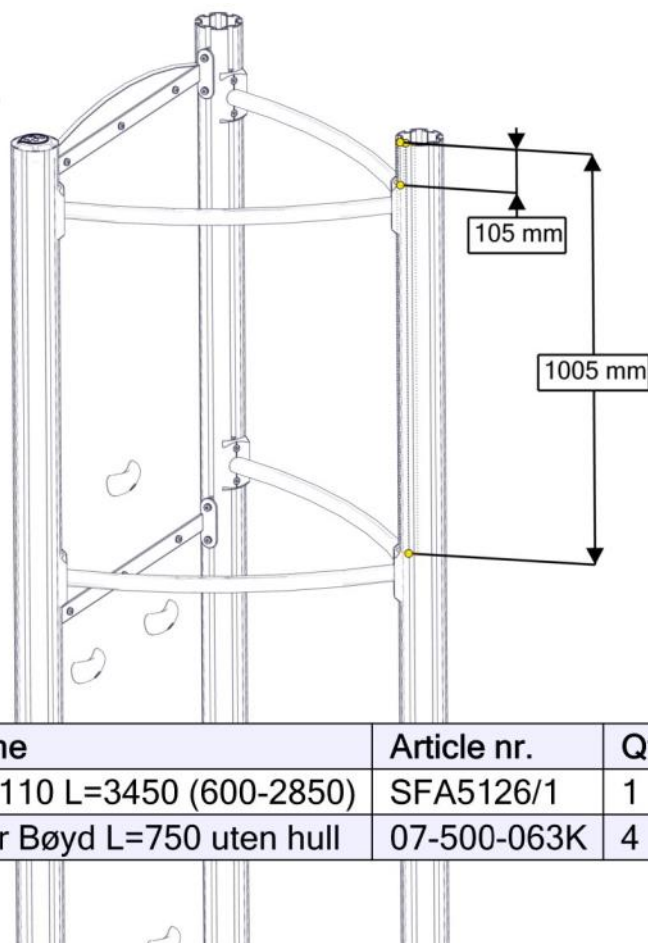

Part Name	Article nr.	Qty
Stolpe Ø110 L=3450 (600-2850)	SFA5126/1	1
Sperrerør Bøyd L=750 uten hull	07-500-063K	4

Se separat delmontering for detaljer
 See separate assembly for details
 Se separata delmontering för detaljer

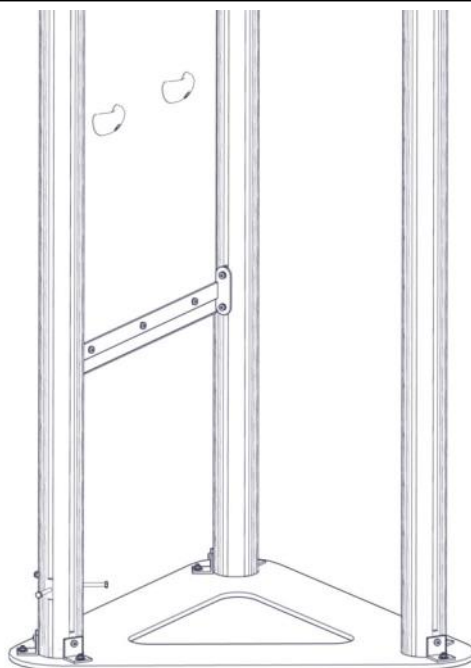

Part Name	Article nr.	Qty
Fundamentplater 3x110 stolpe	07-400-103K	1

Se separat delmontering for detaljer
 See separate assembly for details
 Se separata delmontering för detaljer

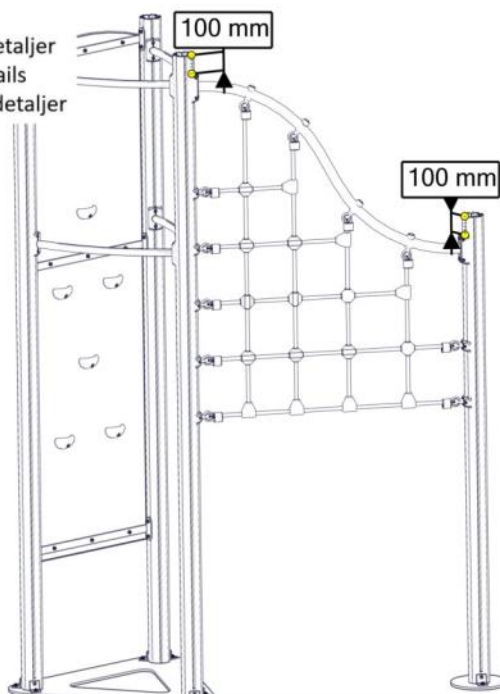

Part Name	Article nr.	Qty
Stolpe Ø110 L=2500 (1900-600)	SFA5126/1	1
S-nett inkl beslag og rør komplett	07-500-017K	1
Fundamentplate 1x110 stolpe komplett	07-400-101K	1

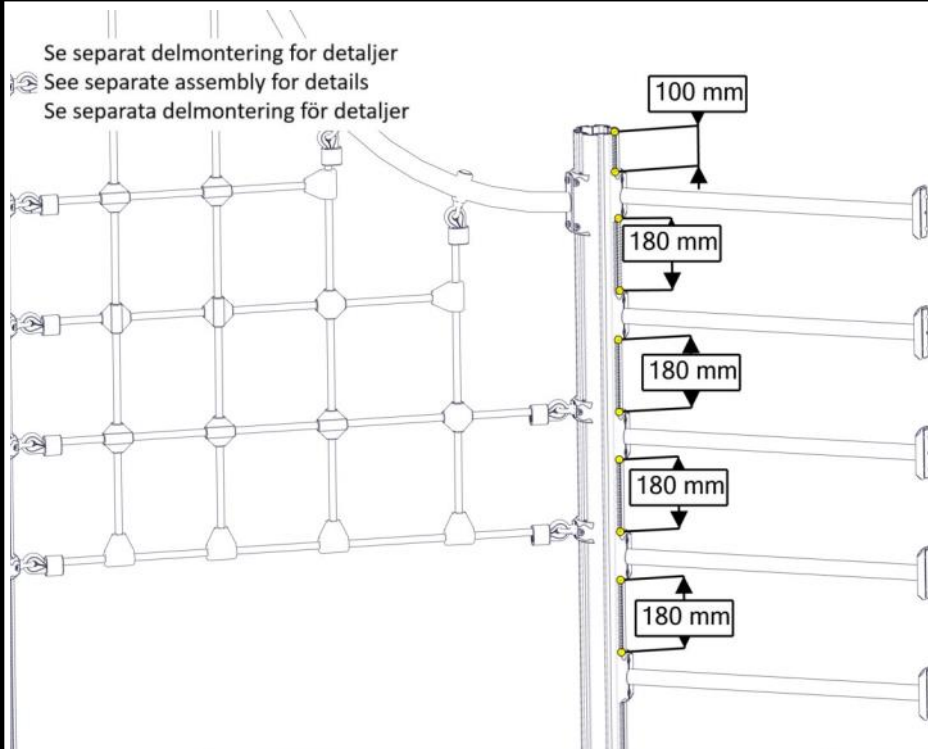

Part Name	Article nr.	Qty
Sperrerør rett L=750 uten hull komplett	07-500-061K	5

Se separat delmontering for detaljer
 See separate assembly for details
 Se separata delmontering för detaljer

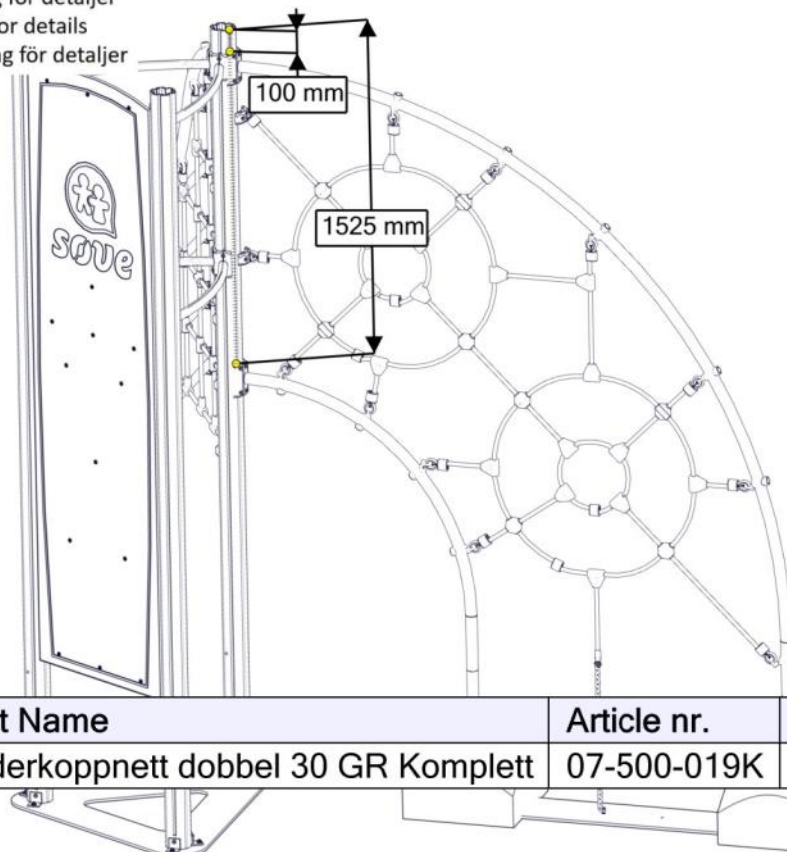



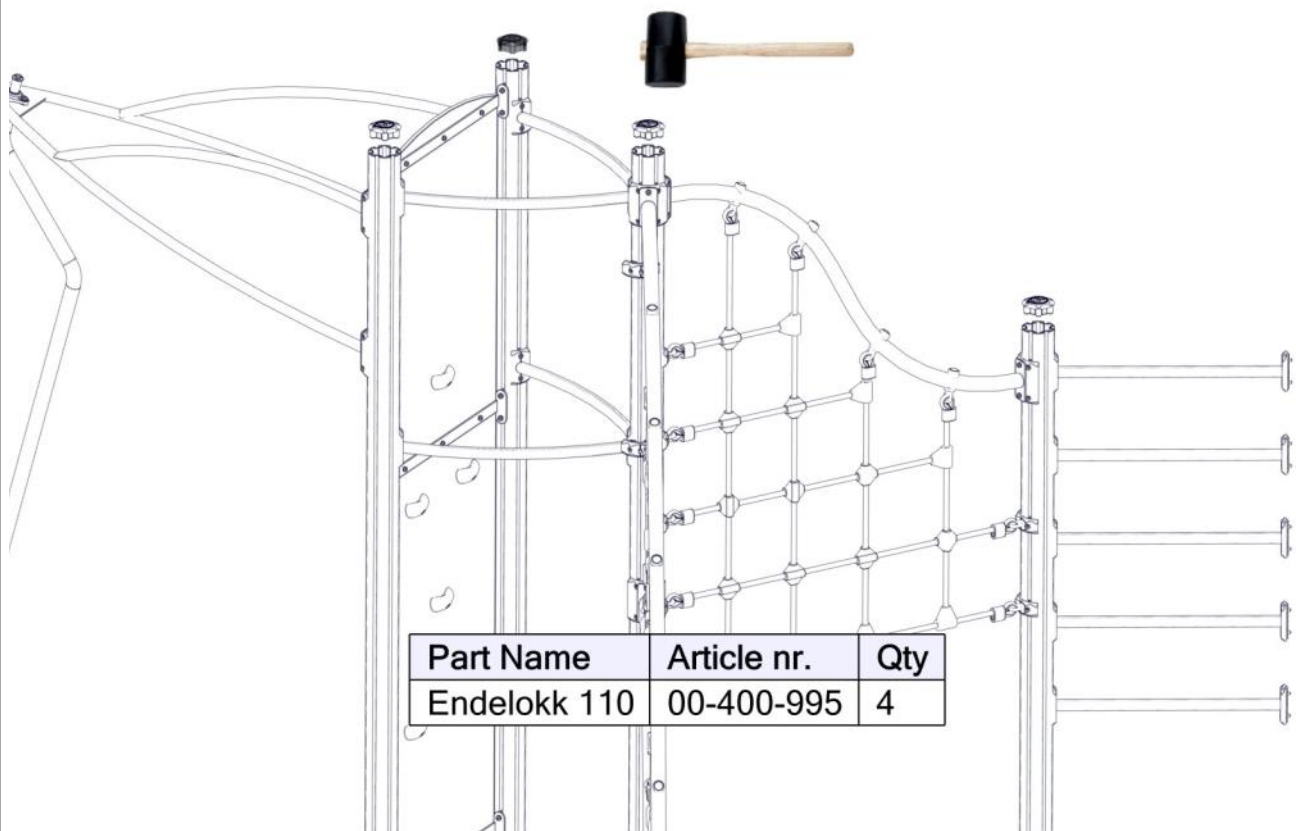
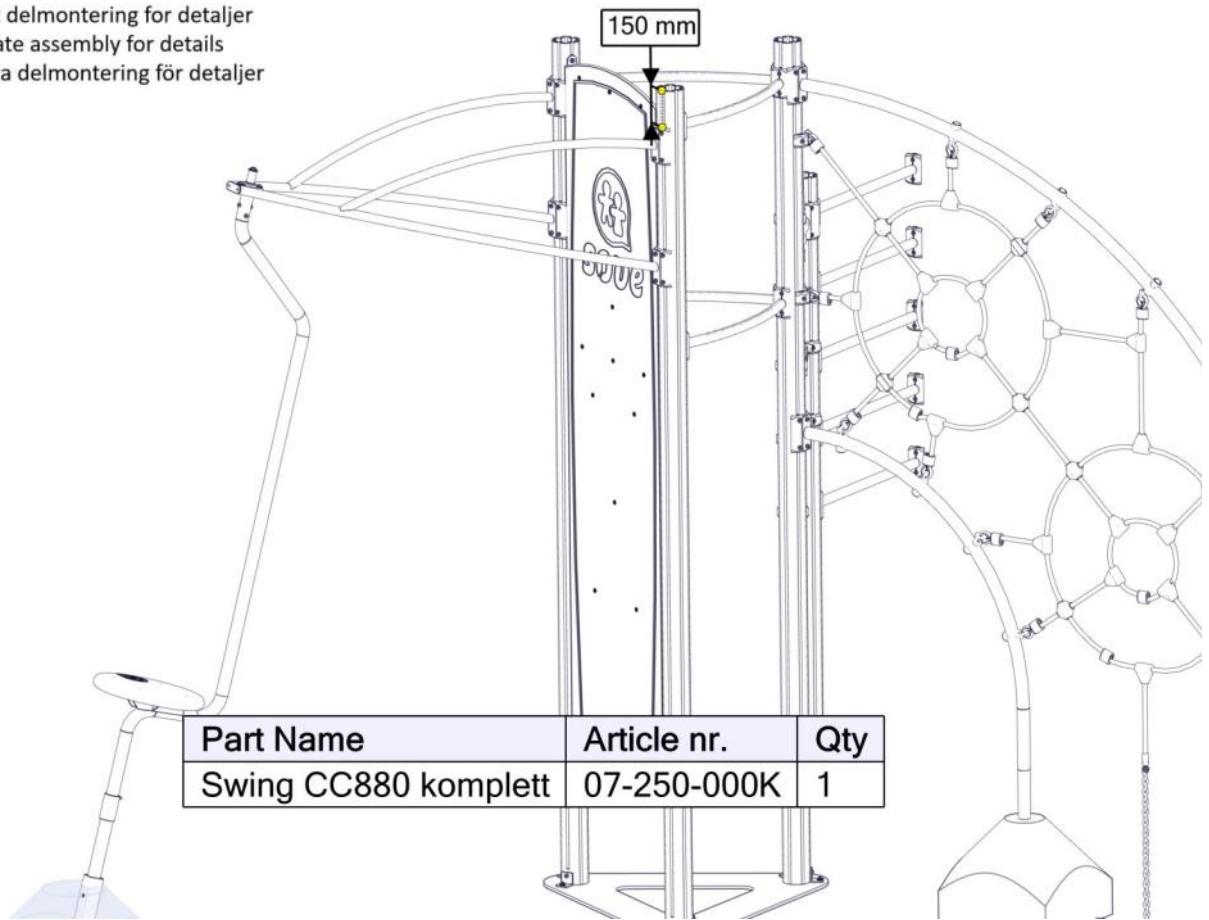

Part Name	Article nr.	Qty
Edderkoppnett dobbel 30 GR Komplett	07-500-019K	1

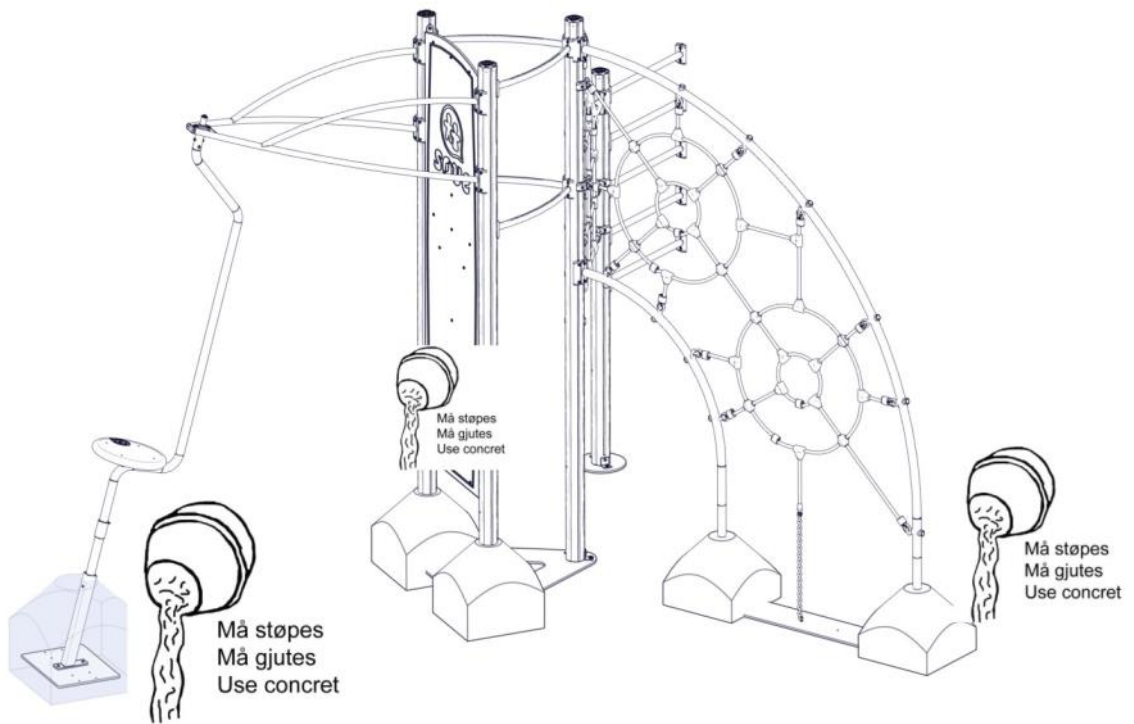
Se separat delmontering for detaljer
 See separate assembly for details
 Se separata delmontering för detaljer



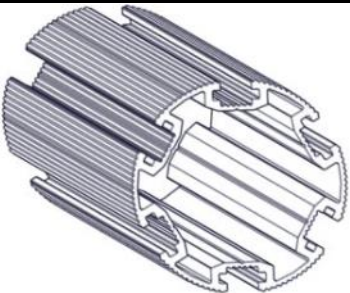

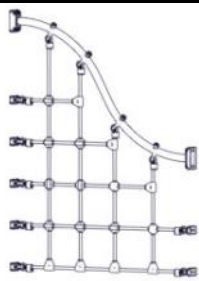

Før utstyret tas i bruk / Before play begins / Innan lekredskapet tas i bruk	
N	<ul style="list-style-type: none"> ● Påse at fallunderlag er utlagt i henhold til gjeldende regler eller vår anbefaling ● Fjern alle monteringshjelpemidler (rester av betong, planker, paller, plast, og lignende) ● Før utstyret tas i bruk, burde man sjekke at det ikke er fare for at anorakksnorer og lignende som kan hekte seg fast noen steder på lekeapparatet. (Vedlagte snor med dobbe (kneledd) kan brukes til å sjekke at dette er i orden. Se vedlagte veiledning for bruk av denne. Dette gjøres for å oppdage eventuelle feilmonteringer.) ● NB! Bør stå i 2-3 dager før bruk
EN	<ul style="list-style-type: none"> ● Make sure the area and depth of safer surfacing are according to the current standard, or to the manufacturer's recommendation ● Make sure all tools and surplus materials are removed before play begins ● PS! When complete, allow 2-3 days for the concrete to set before use
S	<ul style="list-style-type: none"> ● Kontrollera att fallunderlag är utlagt enligt gällande regler eller vårt rekommendation ● Ta bort alla monteringshjälpmedel (rester av betong, plankor, pallar, plast och liknande) ● Innan lekredskapet används, kontrollera att anoracksnoddar eller kläder/delar av kläder eller liknande inte kan fastna i några delar på redskapet. (Den bipackade "knävringen" kan man med fördel användas för denna kontroll. ● Detta görs för att upptäcka eventuella felmonteringar.)

Boltepakker for / Boltpackage for / Bultpaket för		Sign. _____		
Rød-brun 07-302-043	Navn	Artnr/ dimensjon	Ant	Lev
	Stolpe Ø110 L=3450 (2850-600) Stolpe Ø110 L= 2500 (1900-600) Brun	SFA5126/1 SFA5126/1	3 1	
	Klatreplate/ vegg Søve logo komplett Rød	07-300-110K (Se egen del- montering)	1	
	Sperrerør bøyd uten hull L=750 Rød	07-500-063K (Se egen del- montering)	4	
	S-Nett inkludert beslag og rør Rød	07-500-017K (Se egen del- montering)	1	
	Sperrerør rett uten hull L= 750 Rød	07-500-061K (Se egen del- montering)	5	
	Edderkoppnett dobbel 30Gr Komplett Rød	07-500-019K (Se egen del- montering)	1	

Boltepakker for / Boltpackage for / Bultpaket för

Sign. _____.

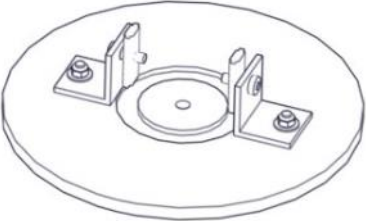
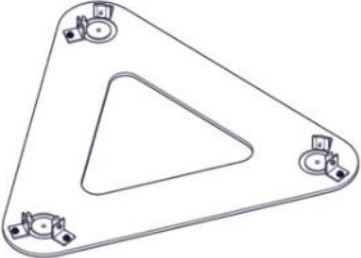
Rød-brun 07-302-043	Navn	Artnr/ dimensjon	Ant	Lev
	Swing komplett CC880 Rød	07-250-000K (Se egen del- montering)	1	
	Endelukk Ø110	00-400-995	4	
	Fundamentplate 1x110 stolpe	07-400-101K (Se egen del- montering)	1	
	Fundamentplate 3x110 stolpe	07-400-103K (Se egen del- montering)	1	