

N

Monteringsanvisning

EN

Assembly Instructions

S

Monteringsanvisning

Produkt nr. / Product no. / Produkt nr.

07-302-202**Thorium Del 1 med spill**

Ord. nr. _____

Dato. _____

Sign. _____

Mount tower on his side.

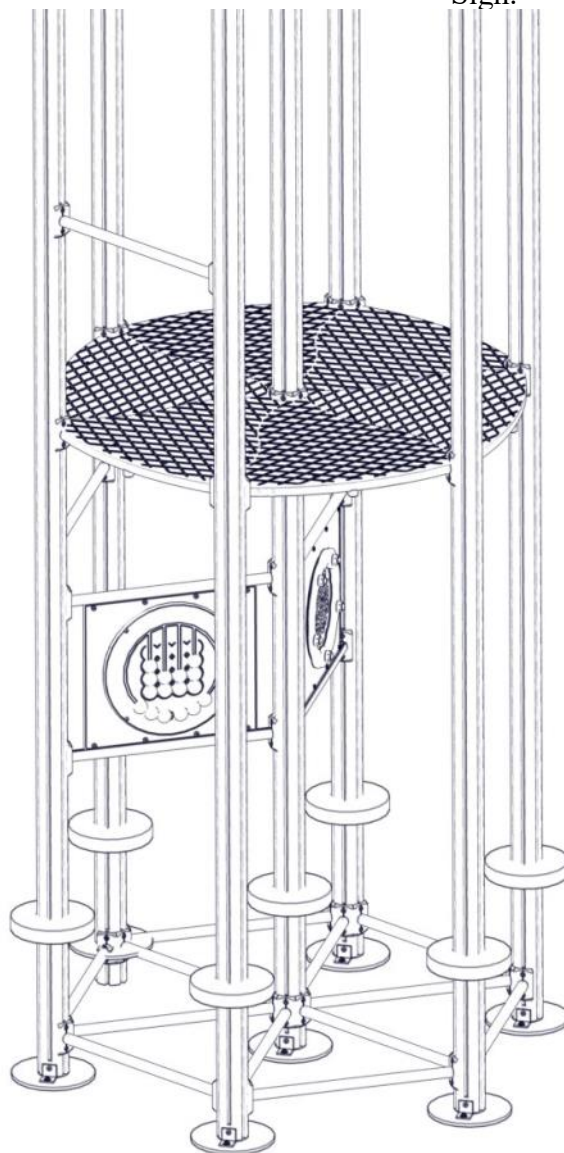





Søve AS
Grønnvoldveien 290
3830 Ulefoss - Norway
Tlf: +47 35 94 65 65
www.sove.no



Søve AB
EA Rosengrensgatan 32
421 31 Västra Frölunda
Phone: +46 (0)31 773 97 00
www.sove.se

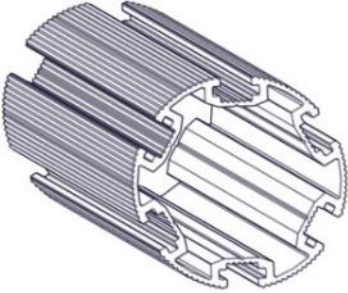

Boltepakker for / Boltpackage for / Bultpaket för

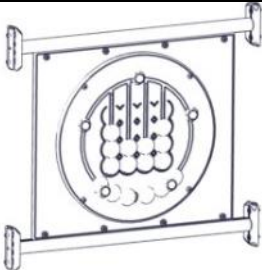
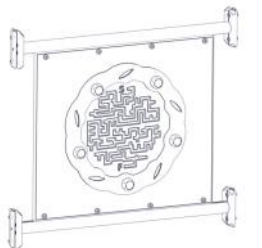

Sign. _____

Thorium Tårn-dell 07-302-202	Navn	Artnr/dimensjon	Ant	Lev
	Stolpe Ø110 L=6450 Grå	SFA5126/2	1	
	Stolpe Ø110 L=6000 Grå	SFA5126/2	6	
	Sperrerør 6-kant gulv Rett L=750 2 hull Sort	07-500-064K (se egen delmontering)	6	
	Sperrerør 6-kant gulv Bøyd L=750 1 hull Sort	07-500-060K (se egen delmontering)	6	
	Sperrerør Rett L=750 Uten hull Grønn	07-500-059K (se egen delmontering)	2	
	Rekkverk 3 in a row CC880 Grønn	07-511-001K (Se egen delmontering)	1	
	Rekkverk labyrint/maze CC880 Grønn	07-511-021K (Se egen delmontering)	1	

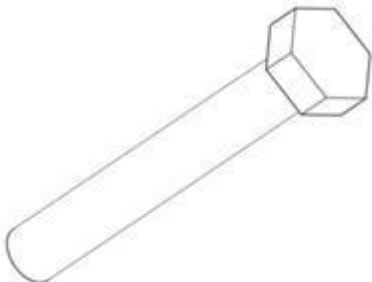
Boltepakker for / Boltpackage for / Bultpaket för

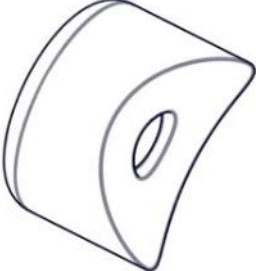
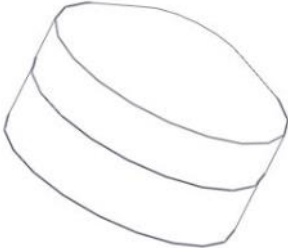
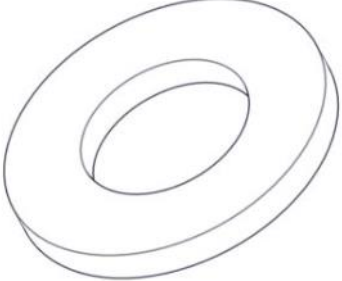
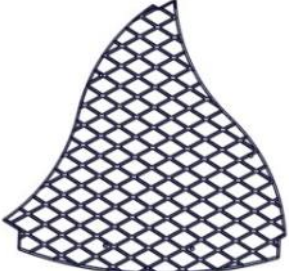

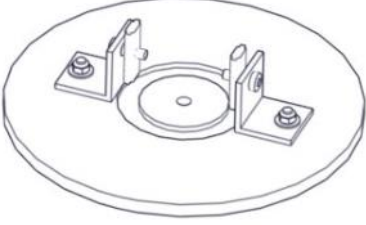
Sign. _____

Thorium Tårn-dell 07-302-202	Navn	Artnr/dimensjon	Ant	Lev
	Sekskant skrue M8x50	04-008-050	18	
	Møbelknapp M8x11	04-030-011	18	
	Plast rørfeste	05-301-036	18	
	Plast rørfeste endelokk	05-301-036	18	
	Skive M8 stor	04-055-008	18	
	Gulv 6-kant Standard Grå	07-301-120	6	

Boltepakker for / Boltpackage for / Bultpaket för		Sign. _____		
Thorium Tårn-dell 07-302-202	Navn	Artnr/dimensjon	Ant	Lev
	Fundament Støpefrie			
	Sperrerør Rett L=750 Uten hull Sort	07-500-075K (se egen delmontering)	12	
	Fundament plate 1xØ110 stolpe	07-400-101K (se egen delmontering)	7	
	Fundament Støp			
	Sperrerør Rett L=750 Uten hull Sort	07-500-075K (se egen delmontering)	12	
	Fundament støp	00-003-111K (se egen delmontering)	7	

Boltepakker for / Boltpackage for / Bultpaket för

Sign. _____.

Thorium Tårn-dell 07-302-202	Navn	Artnr/dimensjon	Ant	Lev
	Fundament Overflatemon- tering			
	Fundament 3x 110 stolpe for betongdekk	00-003-115K (se egen delmontering)	1	
	Fundament 2x110 stolpe for betongdekke	00-003-114K (se egen delmontering)	2	

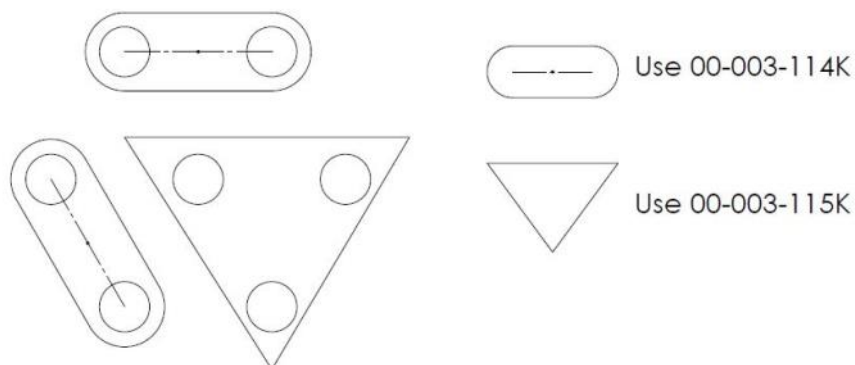

Montering av lekeapparatet / Assembly instructions / Montering av lekredskapet

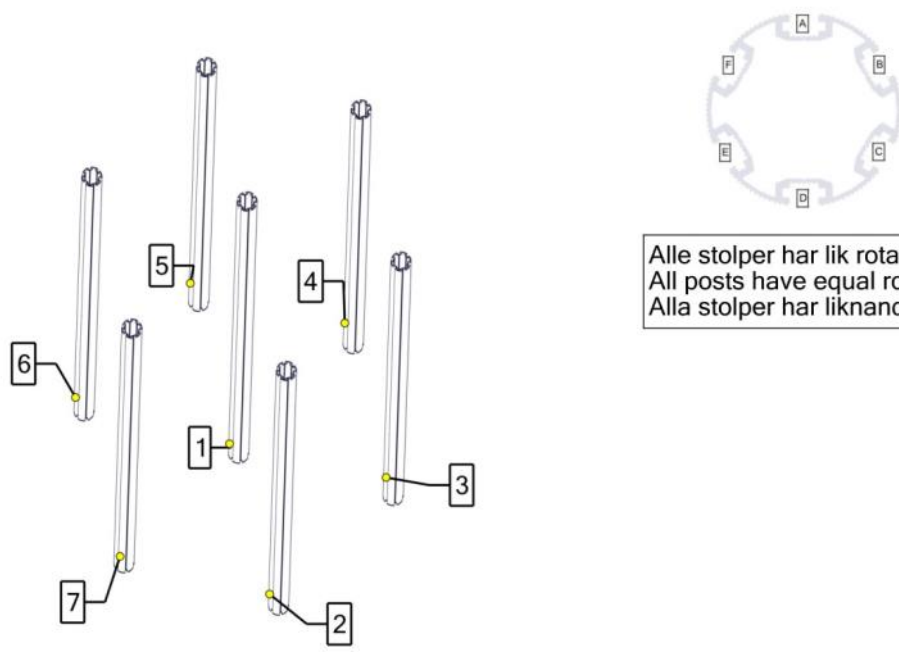

Alle stolper har lik rotasjon
All posts have equal rotation
Alla stolper har liknande vridning

Part Name	Article nr.	Qty
Stolpe Ø110 Lengde=6450	SFA5126/2	1
Stolpe Ø110 Lengde=6000	SFA5126/2	6

Se separat delmontering for detaljer
See separate assembly for details
Se separata delmontering för detaljer

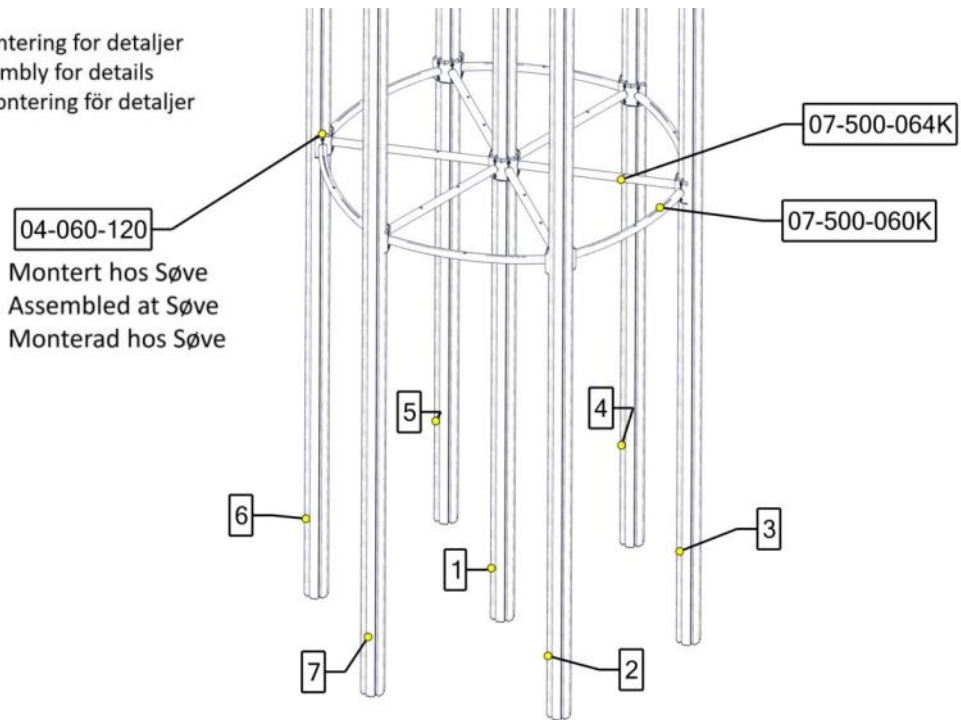

04-060-120
Montert hos Søve
Assembled at Søve
Monterad hos Søve

Part Name	Article nr.	Qty
Sperrerør Bøyd L=750 m hull gulv komplet	07-500-060K	6
Sperrerør 6-kant gulv L=750 2 hull	07-500-064K	6

Montering av lekeapparatet / Assembly instructions / Montering av lekredskapet

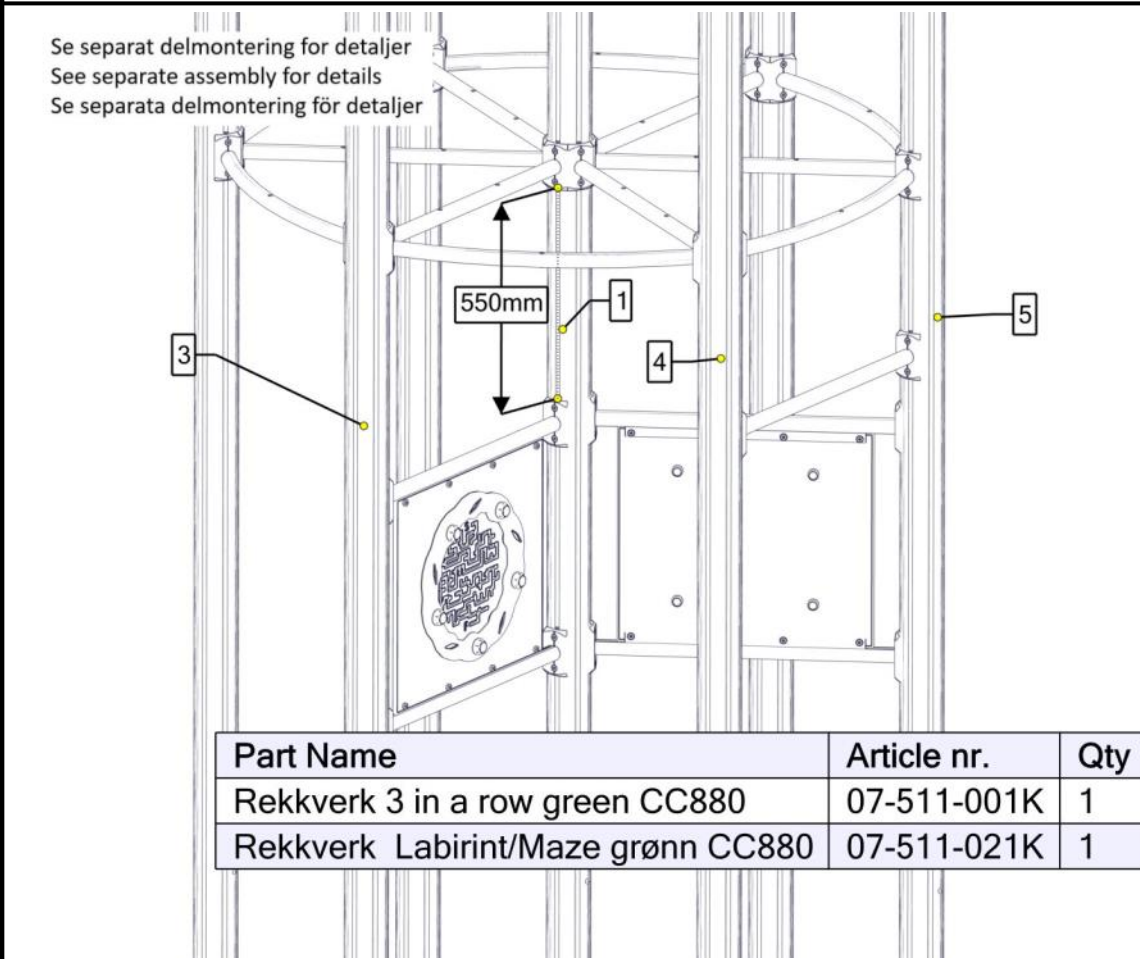
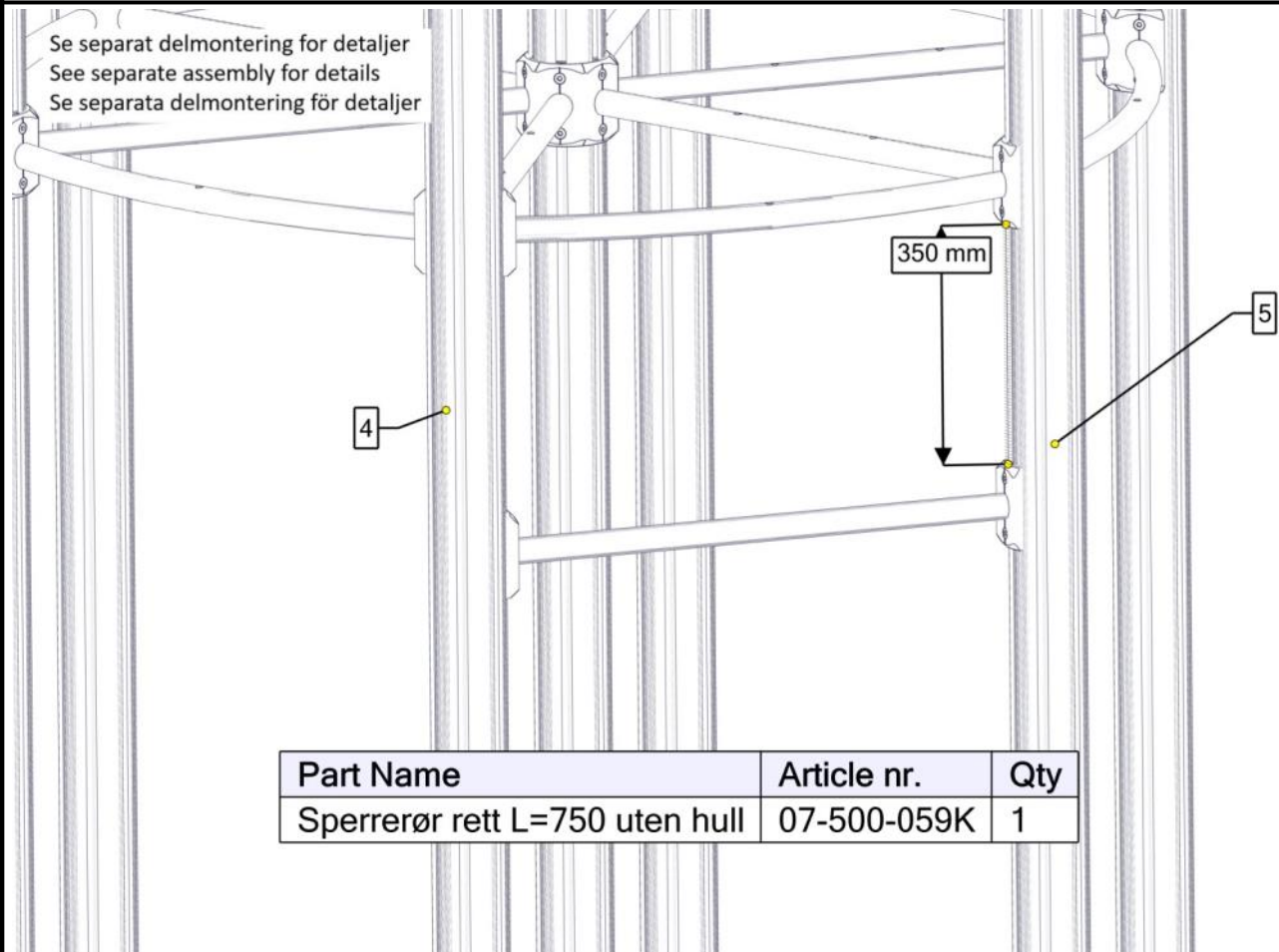

Se separat delmontering for detaljer
 See separate assembly for details
 Se separata delmontering för detaljer

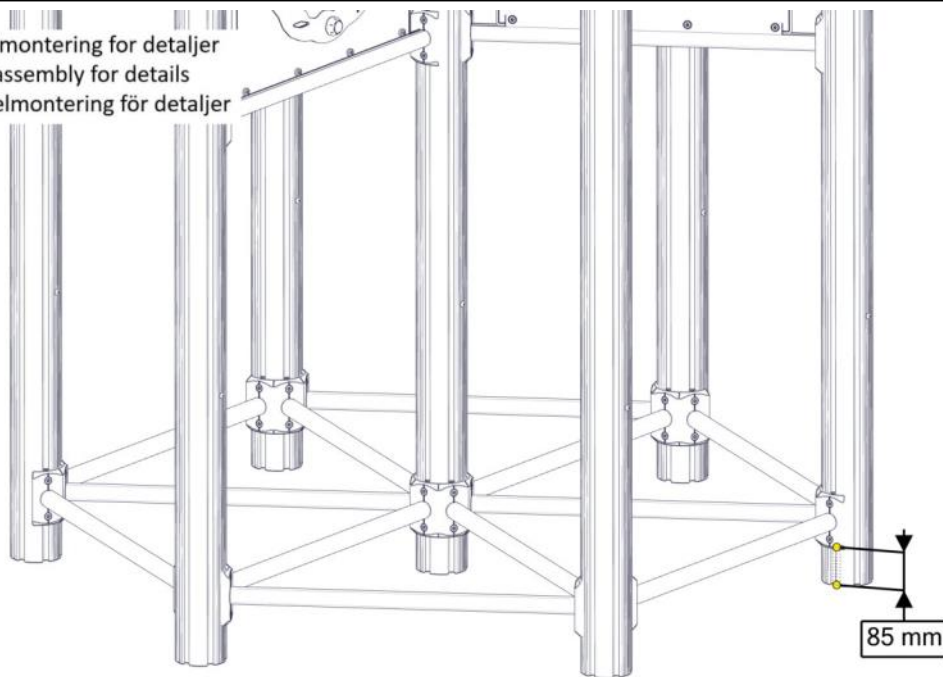

Part Name	Article nr.	Qty
Sperrerør rett L=750 uten hull	07-500-075K	12

Se separat delmontering for detaljer
 See separate assembly for details
 Se separata delmontering för detaljer

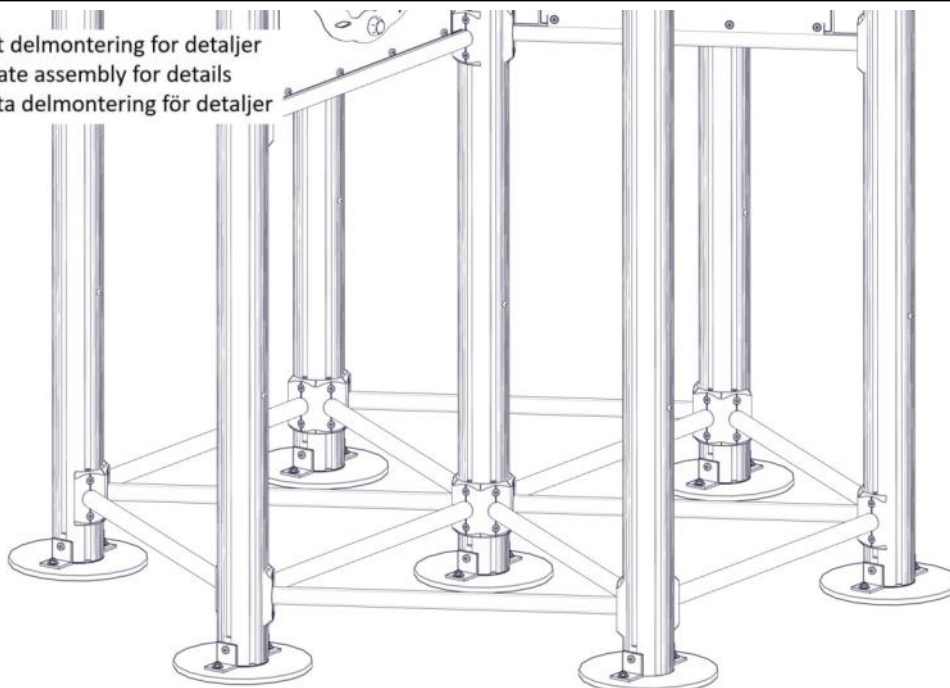

Part Name	Article nr.	Qty
Fundamentplate 1x110 stolpe komplett	07-400-101K	7

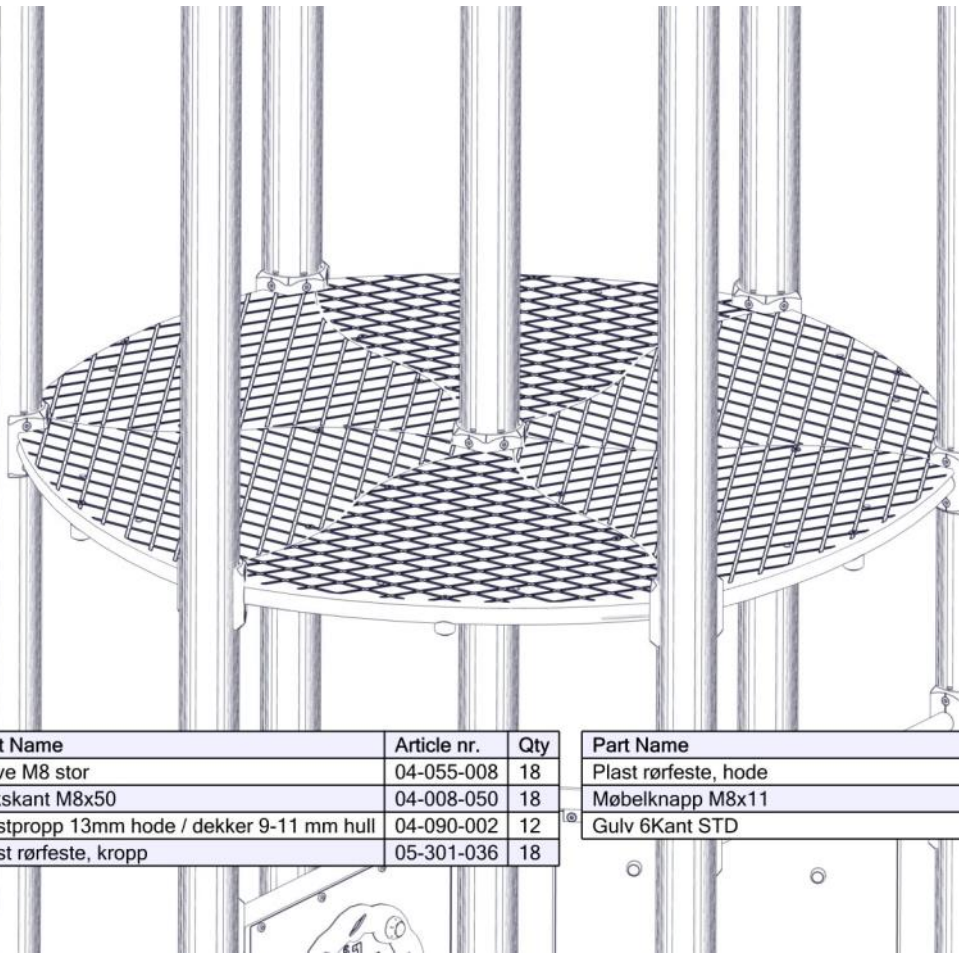

Part Name	Article nr.	Qty
Skive M8 stor	04-055-008	18
Sekskant M8x50	04-008-050	18
Plastpropp 13mm hode / dekker 9-11 mm hull	04-090-002	12
Plast rørfeste, kropp	05-301-036	18

Part Name	Article nr.	Qty
Plast rørfeste, hode	05-301-036	18
Møbelknapp M8x11	04-030-011	18
Gulv 6Kant STD	07-301-120	6

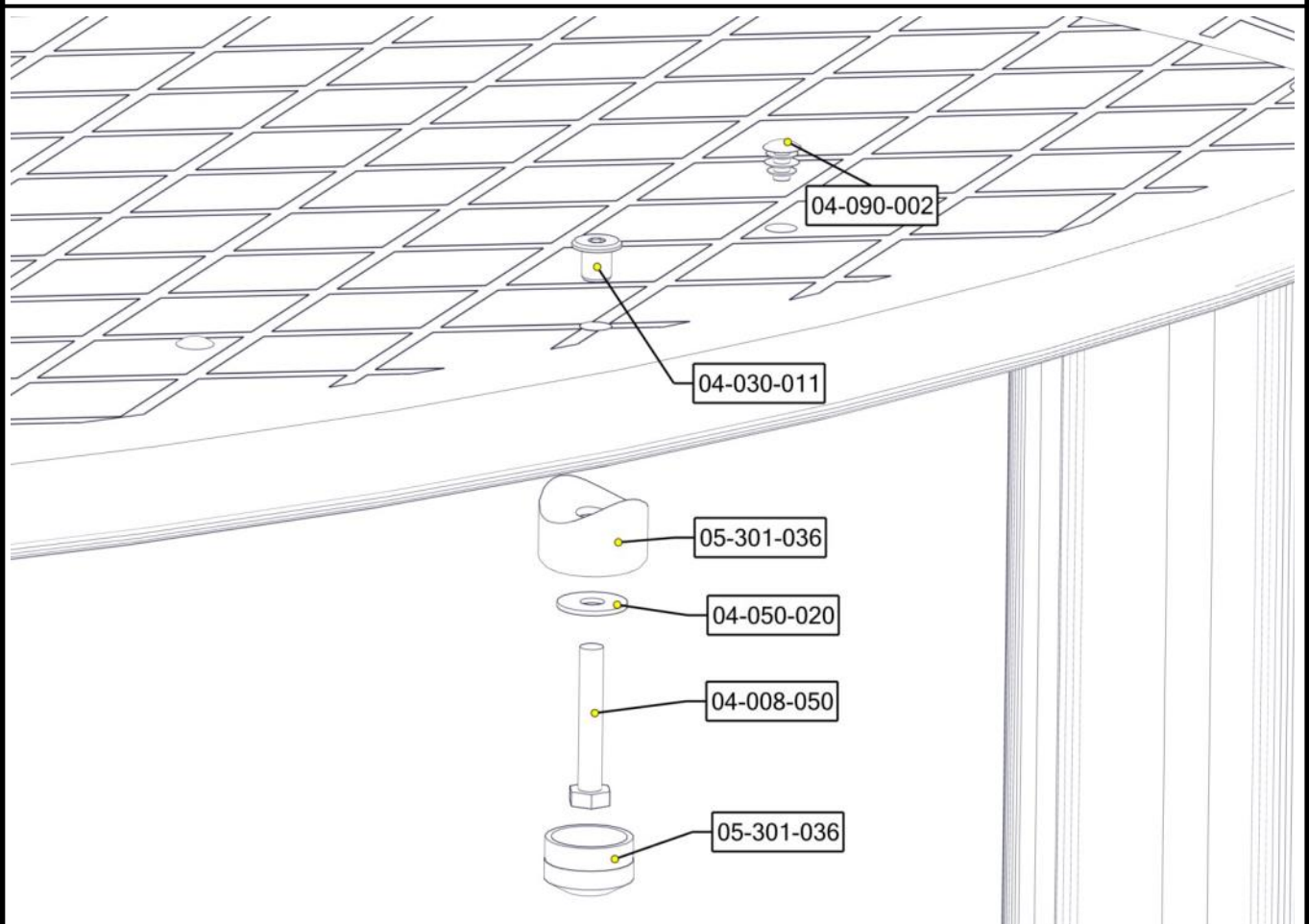



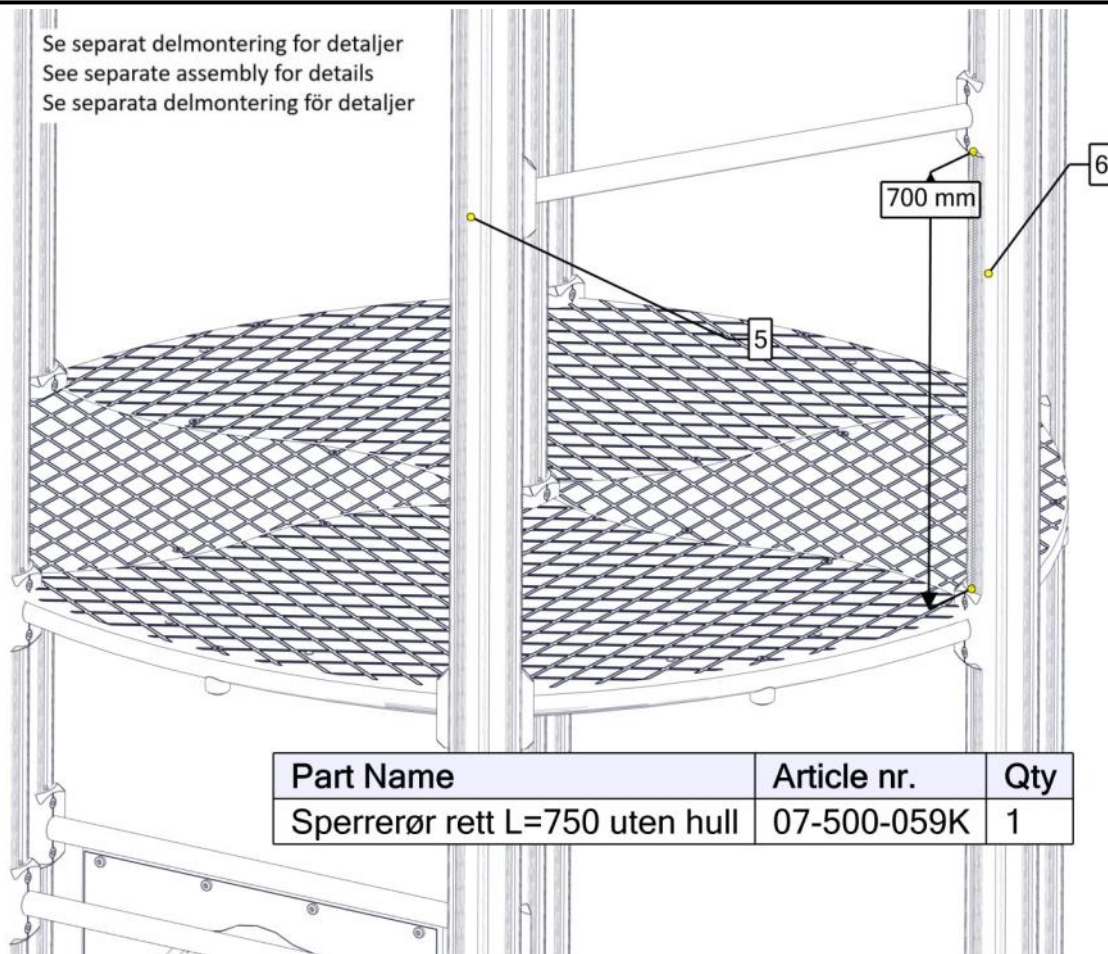

Se separat delmontering for detaljer
See separate assembly for details
Se separata delmontering för detaljer



Part Name	Article nr.	Qty
Sperrerør rett L=750 uten hull	07-500-059K	1

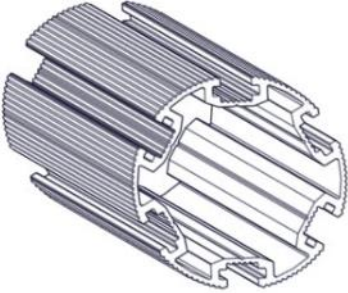

Boltepakker for / Boltpackage for / Bultpaket för

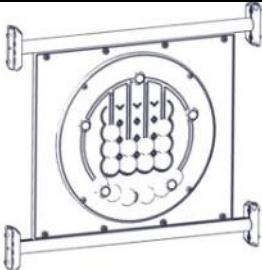
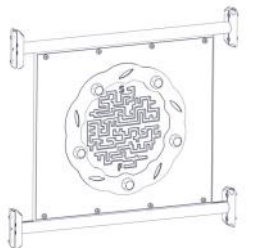

Sign. _____

Thorium Tårn-dell 07-302-202	Navn	Artnr/dimensjon	Ant	Lev
	Stolpe Ø110 L=6450 Grå	SFA5126/2	1	
	Stolpe Ø110 L=6000 Grå	SFA5126/2	6	
	Sperrerør 6-kant gulv Rett L=750 2 hull Sort	07-500-064K (se egen delmontering)	6	
	Sperrerør 6-kant gulv Bøyd L=750 1 hull Sort	07-500-060K (se egen delmontering)	6	
	Sperrerør Rett L=750 Uten hull Grønn	07-500-059K (se egen delmontering)	2	
	Rekkverk 3 in a row CC880 Grønn	07-511-001K (Se egen delmontering)	1	
	Rekkverk labyrint/maze CC880 Grønn	07-511-021K (Se egen delmontering)	1	

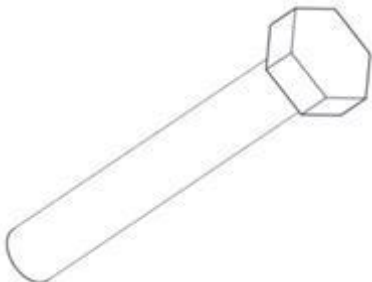
Boltepakker for / Boltpackage for / Bultpaket för

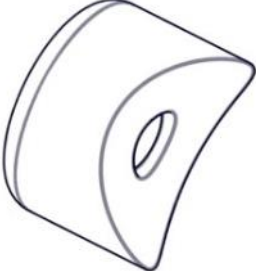
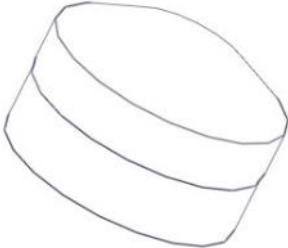
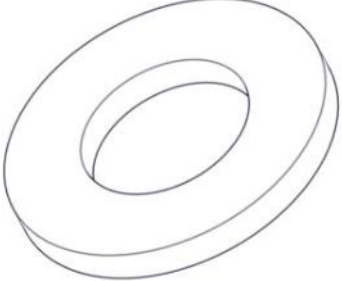
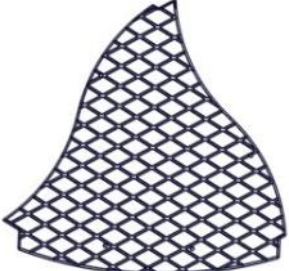

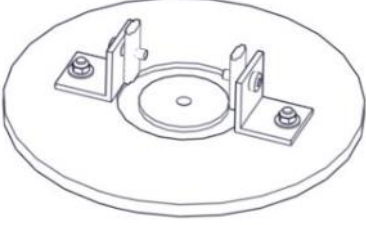
Sign. _____

Thorium Tårn-dell 07-302-202	Navn	Artnr/dimensjon	Ant	Lev
	Sekskant skrue M8x50	04-008-050	18	
	Møbelknapp M8x11	04-030-011	18	
	Plast rørfeste	05-301-036	18	
	Plast rørfeste endelokk	05-301-036	18	
	Skive M8 stor	04-055-008	18	
	Gulv 6-kant Standard Grå	07-301-120	6	

Boltepakker for / Boltpackage for / Bultpaket för		Sign. _____		
Thorium Tårn-dell 07-302-202	Navn	Artnr/dimensjon	Ant	Lev
	Fundament Støpefrie			
	Sperrerør Rett L=750 Uten hull Sort	07-500-075K (se egen delmontering)	12	
	Fundament plate 1xØ110 stolpe	07-400-101K (se egen delmontering)	7	
	Fundament Støp			
	Sperrerør Rett L=750 Uten hull Sort	07-500-075K (se egen delmontering)	12	
	Fundament støp	00-003-111K (se egen delmontering)	7	

Boltepakker for / Boltpackage for / Bultpaket för

Sign. _____.

Thorium Tårn-dell 07-302-202	Navn	Artnr/dimensjon	Ant	Lev
	Fundament Overflatemon- tering			
	Fundament 3x 110 stolpe for betongdekk	00-003-115K (se egen delmontering)	1	
	Fundament 2x110 stolpe for betongdekke	00-003-114K (se egen delmontering)	2	

