

N

Monteringsanvisning

EN

Assembly Instructions

S

Monteringsanvisning

Produkt nr. / Product no. / Produkt nr.

07-302-223**Thorium Tårn del 2**

Ord. nr. _____

Dato. _____



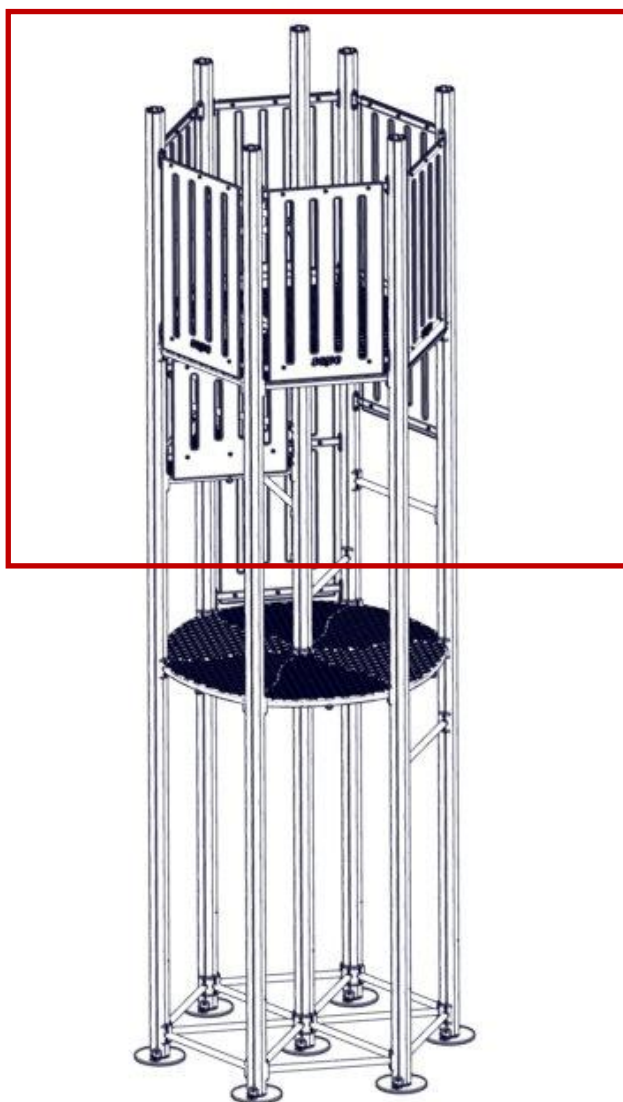

Sign. _____

**søve**

Søve AS
Grønnvoldveien 290
3830 Ulefoss - Norway
Tlf: +47 35 94 65 65
www.sove.no

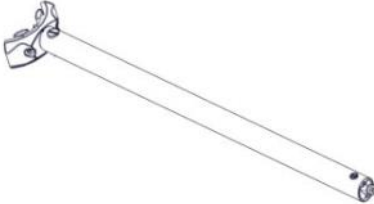
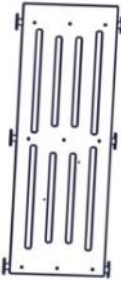

Søve AB
EA Rosengrensgatan 32
421 31 Västra Frölunda
Phone: +46 (0)31 773 97 00
www.sove.se

Boltepakker for / Boltpackage for / Bultpaket för		Sign. _____		
Thorium Tårn-del2 07-302-223	Navn	Artnr/dimensjon	Ant	Lev
	Sperrerør 6-kant gulv Rett L=750 2 hull Sort	07-500-064K (se egen del- montering)	4	
	Sperrerør 6-kant gulv Bøyd L=750 1 hull Sort	07-500-060K (se egen del- montering)	2	
	Sperrerør Rett L=750 Uten hull Sort	07-500-075K (se egen del- montering)	6	
	Sperrerør Rett L=750 Uten hull Grønn	07-500-059K (se egen del- montering)	3	
	Sperrerør Tårn trapp Grønn	07-520-612K (se egen del- montering)	4	
	Rekkverk Tårn Med hull til spiraltrapp 700x1960 Grønn	07-302-107K (se egen del- montering)	1	



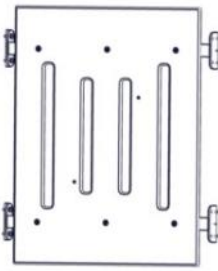
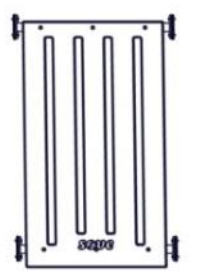
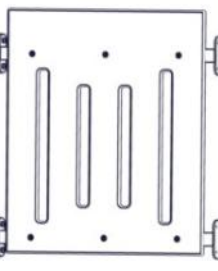
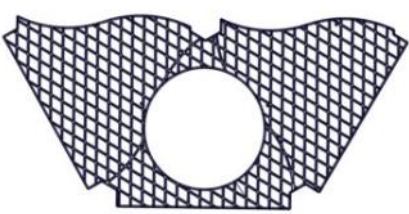
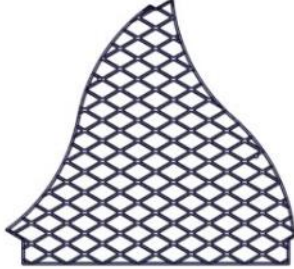
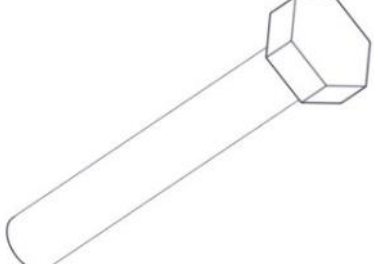

Boltepakker for / Boltpackage for / Bultpaket för

Sign. _____

Thorium Tårn-del2 07-302-223	Navn	Artnr/dimensjon	Ant	Lev
	Rekkverk Tårn Med hull til spiraltrapp 700x765 Grønn	07-302-108K (se egen del- montering)	1	
	Rekkverk Tårn 700x1220 Grønn	07-302-109K (se egen del- montering)	6	
	Rekkverk Tårn 700x765 Grønn	07-302-112K (se egen del- montering)	2	
	Gulv 6-kant Stor m/hull Grå	07-301-124	1	
	Gulv 6-kant Tårn Grå	07-301-126	3	
	Sekskant skrue M8x50	04-008-050	10	

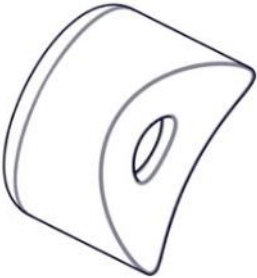
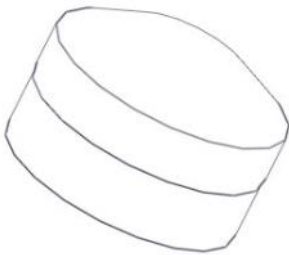
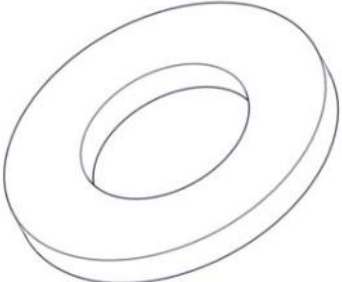
Boltepakker for / Boltpackage for / Bultpaket för

Sign. _____

Thorium Tårn-del2 07-302-223	Navn	Artnr/dimensjon	Ant	Lev
	Plast rørfeste	05-301-036	10	
	Plast rørfeste endelokk	05-301-036	10	
	Skive M8 stor	04-055-008	10	
	Møbelknapp M8x11	04-030-011	10	
	Gulv 3-kant 2 Rett CC880 Grå	07-300-108K (se egen del- montering)	1	
	Låsebolt M8x50	04-081-050	4	

Se separat delmontering for detaljer
 See separate assembly for details
 Se separata delmontering för detaljer

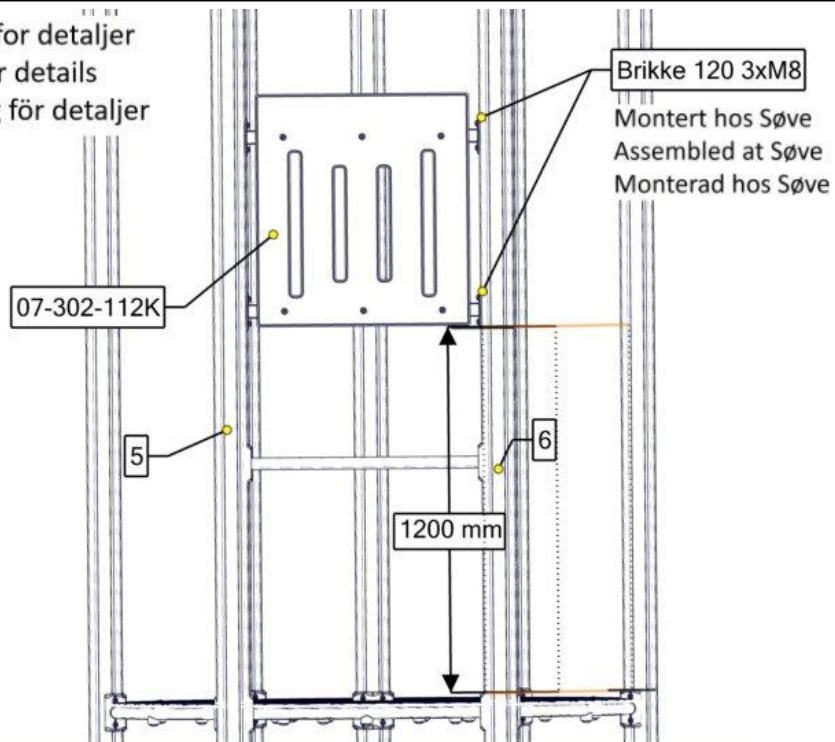

Part Name	Article nr.	Qty
Rekkverk 700x765 for tårn komplett	07-302-112K	1

Se separat delmontering for detaljer
 See separate assembly for details
 Se separata delmontering för detaljer

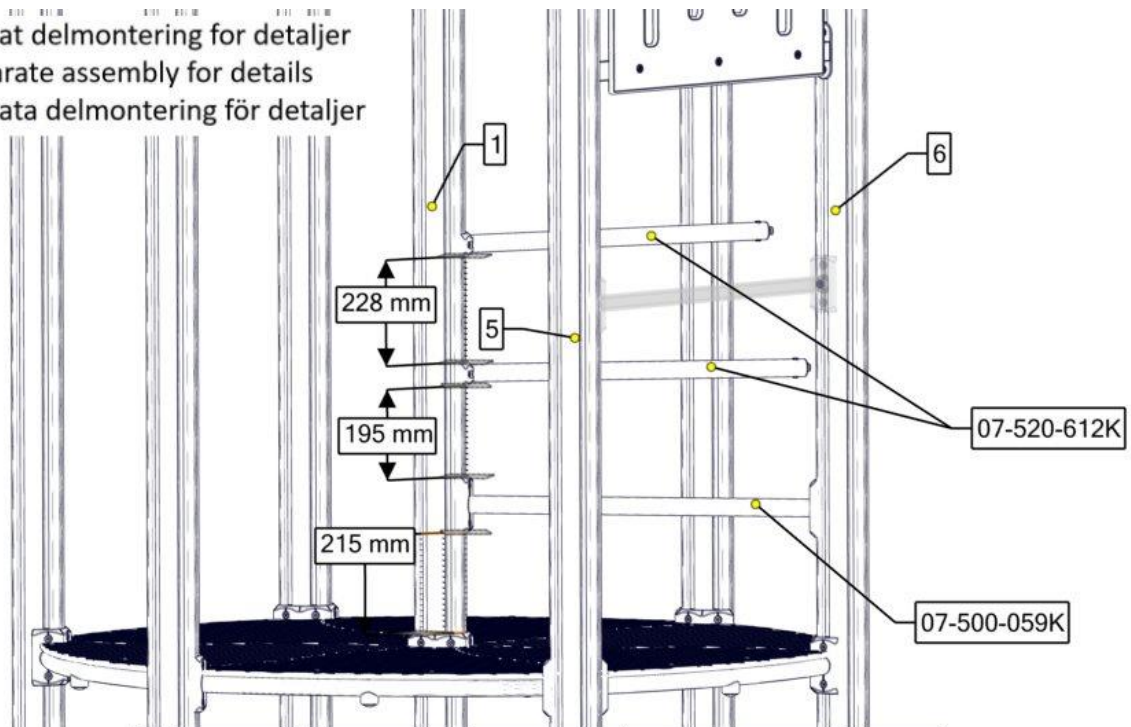

Part Name	Article nr.	Qty
Sperrerør rett L=750 uten hull	07-500-059K	1
Sperrerør tårn trappe komplett	07-520-612K	2

Se separat delmontering for detaljer
 See separate assembly for details
 Se separata delmontering för detaljer

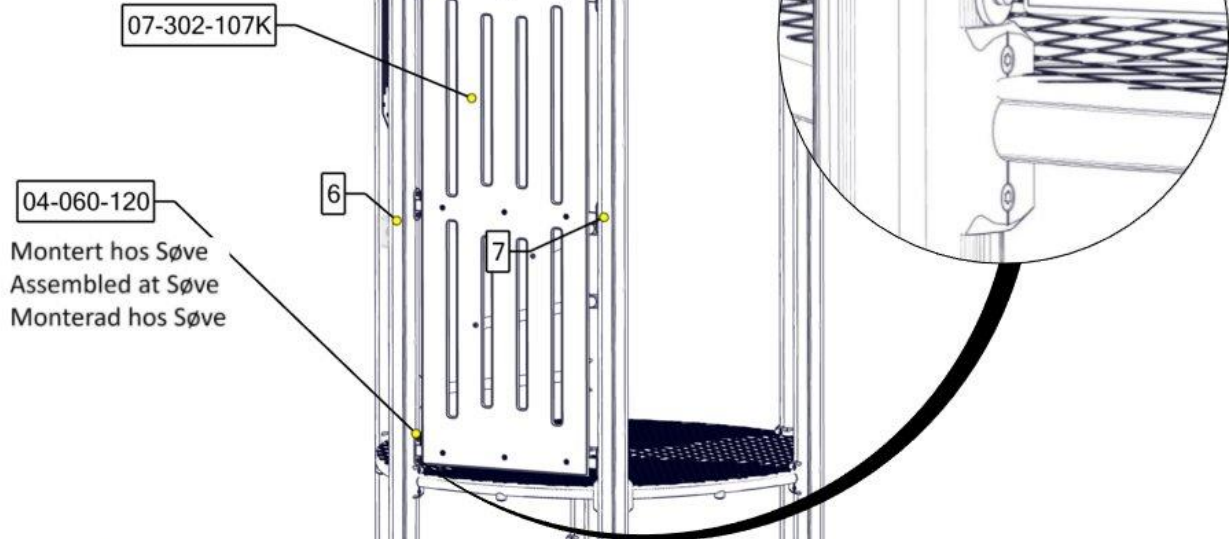

Part Name	Article nr.	Qty
Rekkverk 700x1960 for tårn komplett	07-302-107K	1

Se separat delmontering for detaljer
 See separate assembly for details
 Se separata delmontering för detaljer

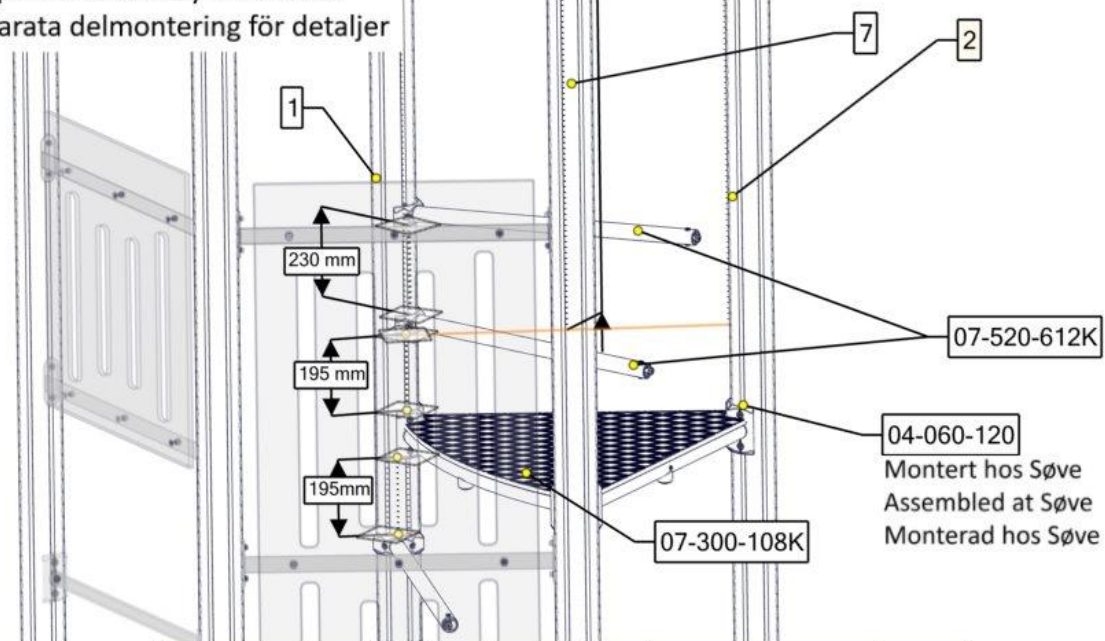

Part Name	Article nr.	Qty
Gulv 3-kant 880x880 2Rett	07-300-108K	1
Sperrerør tårn trappe komplett	07-520-612K	2

Se separat delmontering for detaljer
 See separate assembly for details
 Se separata delmontering för detaljer

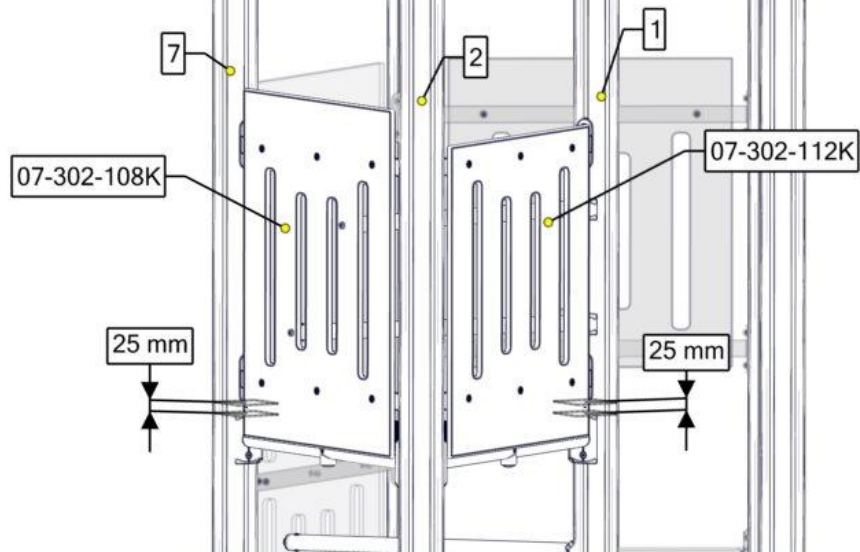

Part Name	Article nr.	Qty
Rekkverk 700x765 for tårn komplett	07-302-112K	1
Rekkverk 700x851 for tårn	07-302-108K	1

Se separat delmontering for detaljer
 See separate assembly for details
 Se separata delmontering för detaljer

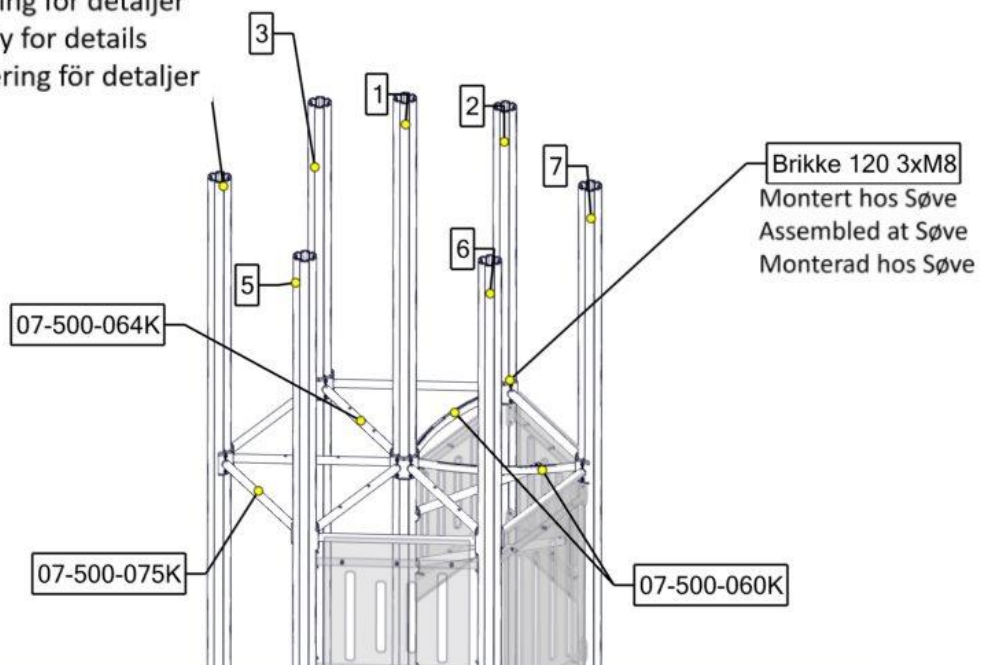

Part Name	Article nr.	Qty
Sperrerør Bøyd L=750 m hull gulv komplet	07-500-060K	2
Sperrerør 6-kant gulv L=750 2 hull	07-500-064K	4
Sperrerør rett L=750 uten hull	07-500-075K	6

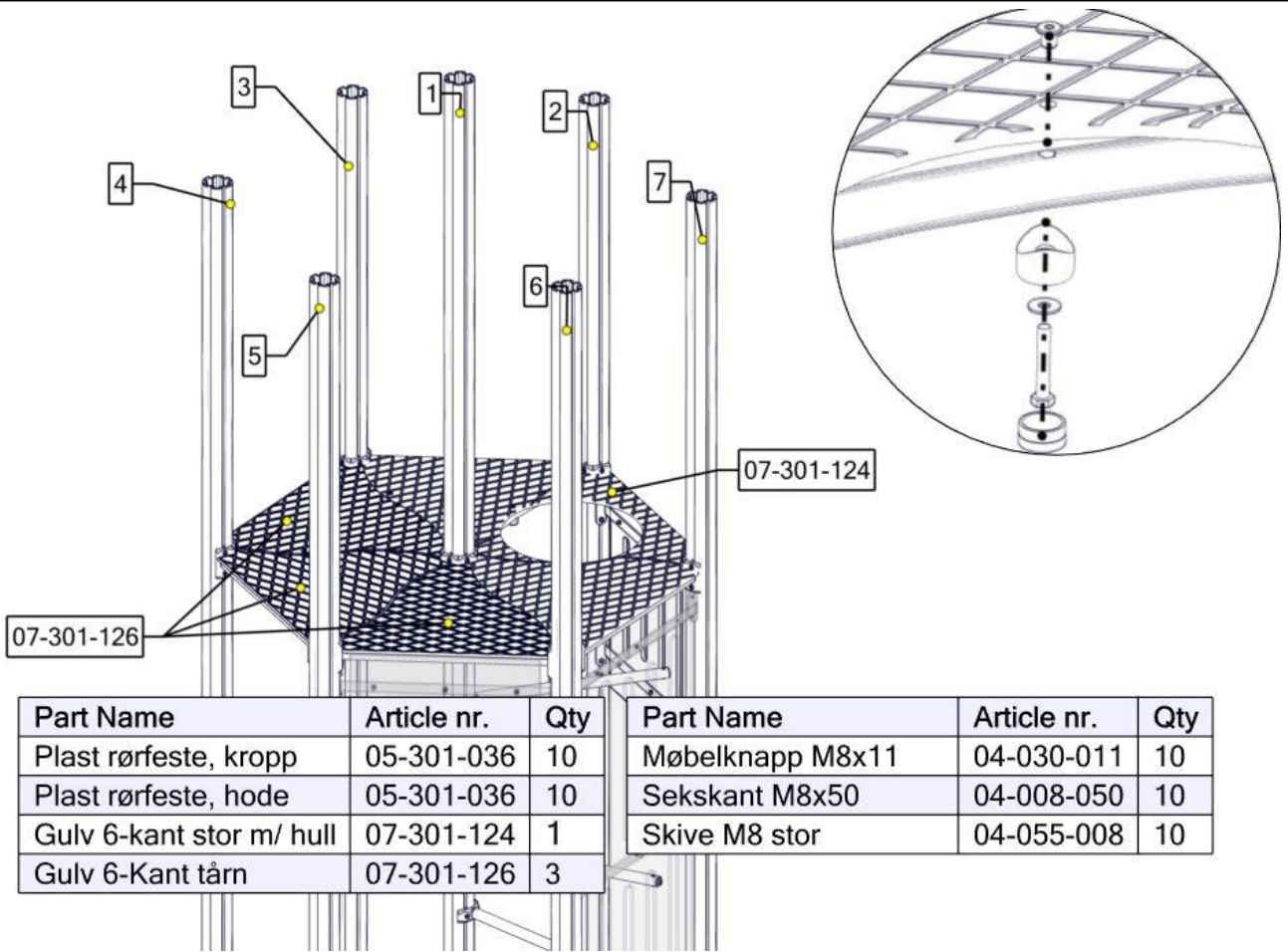

Part Name	Article nr.	Qty	Part Name	Article nr.	Qty
Plast rørfeste, kropp	05-301-036	10	Møbelknapp M8x11	04-030-011	10
Plast rørfeste, hode	05-301-036	10	Sekskant M8x50	04-008-050	10
Gulv 6-kant stor m/ hull	07-301-124	1	Skive M8 stor	04-055-008	10
Gulv 6-Kant tårn	07-301-126	3			

Se separat delmontering for detaljer
 See separate assembly for details
 Se separata delmontering för detaljer

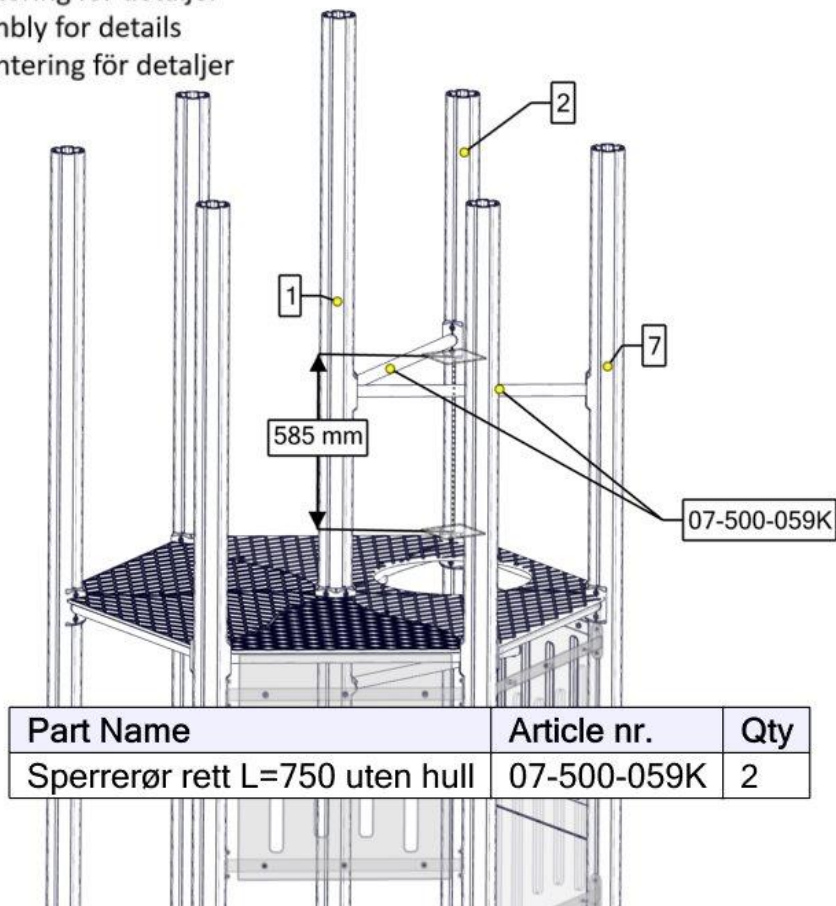

Part Name	Article nr.	Qty
Sperrerør rett L=750 uten hull	07-500-059K	2



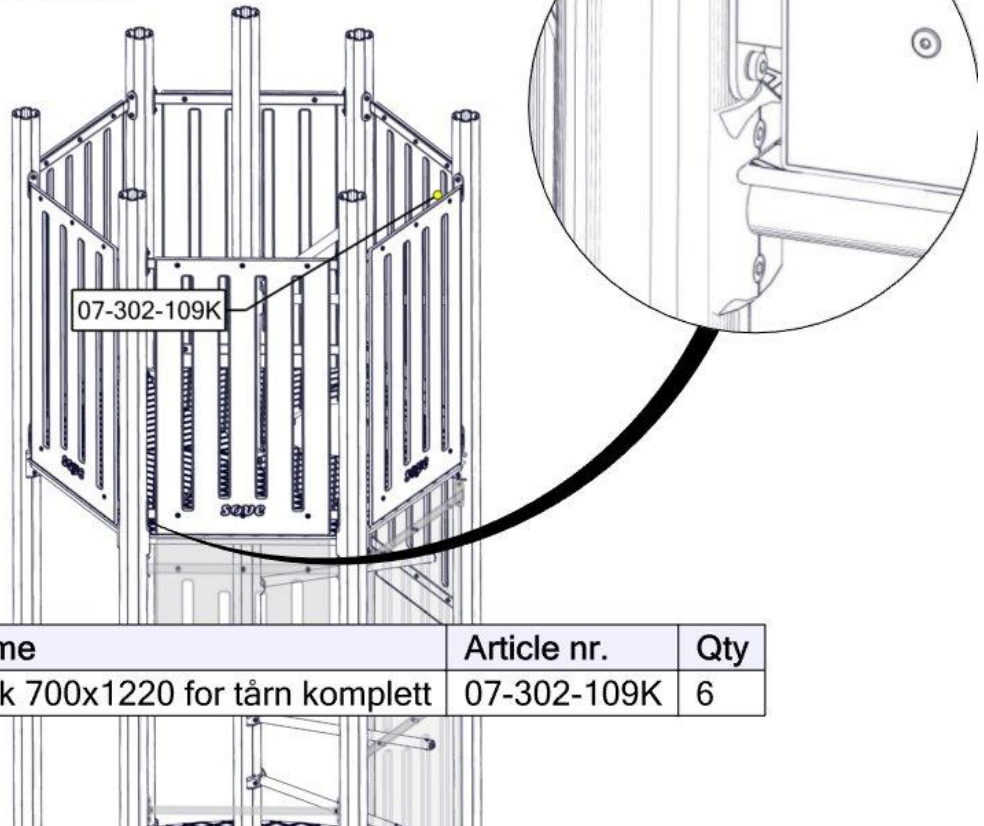

Se separat delmontering for detaljer
See separate assembly for details
Se separata delmontering för detaljer



Part Name	Article nr.	Qty
Rekkverk 700x1220 for tårn komplett	07-302-109K	6

Boltepakker for / Boltpackage for / Bultpaket för



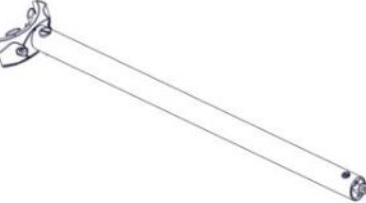
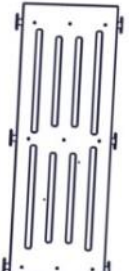

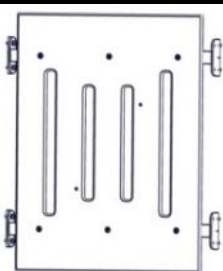
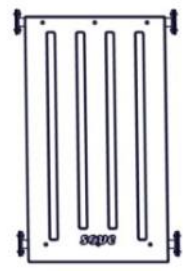
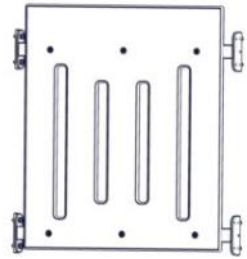
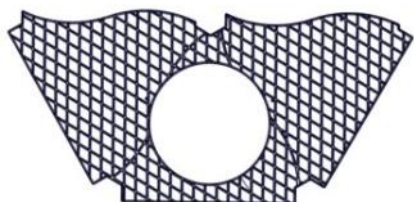
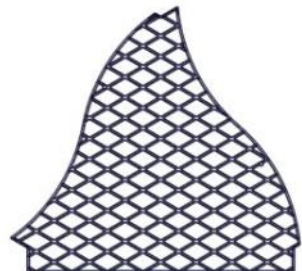
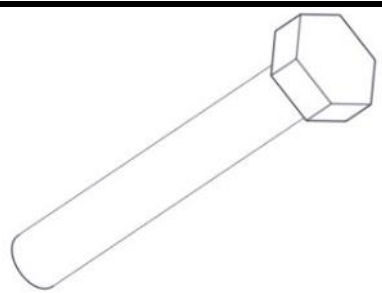
Sign. _____

Thorium Tårn-del2 07-302-223	Navn	Artnr/dimensjon	Ant	Lev
	Sperrerør 6-kant gulv Rett L=750 2 hull Sort	07-500-064K (se egen del- montering)	4	
	Sperrerør 6-kant gulv Bøyd L=750 1 hull Sort	07-500-060K (se egen del- montering)	2	
	Sperrerør Rett L=750 Uten hull Sort	07-500-075K (se egen del- montering)	6	
	Sperrerør Rett L=750 Uten hull Grønn	07-500-059K (se egen del- montering)	3	
	Sperrerør Tårn trapp Grønn	07-520-612K (se egen del- montering)	4	
	Rekkverk Tårn 700x1960 Grønn	07-302-107K (se egen del- montering)	1	

Boltepakker for / Boltpackage for / Bultpaket för		Sign. _____		
Thorium Tårn-del2 07-302-223	Navn	Artnr/dimensjon	Ant	Lev
	Rekkverk Tårn Med hull til spiraltrapp 700x765 Grønn	07-302-108K (se egen del- montering)	1	
	Rekkverk Tårn 700x1220 Grønn	07-302-109K (se egen del- montering)	6	
	Rekkverk Tårn 700x765 Grønn	07-302-112K (se egen del- montering)	2	
	Gulv 6-kant Stor m/hull Grå	07-301-124	1	
	Gulv 6-kant Tårn Grå	07-301-126	3	
	Sekskant skrue M8x50	04-008-050	10	

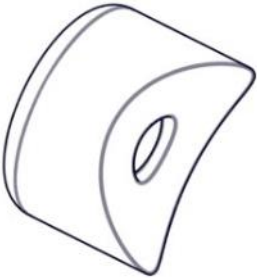
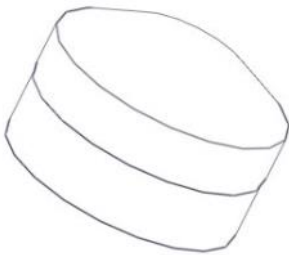
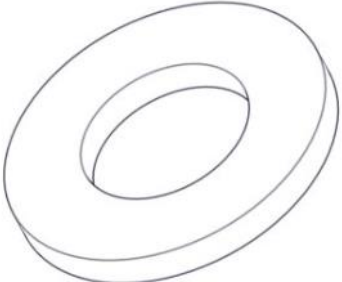
Boltepakker for / Boltpackage for / Bultpaket för

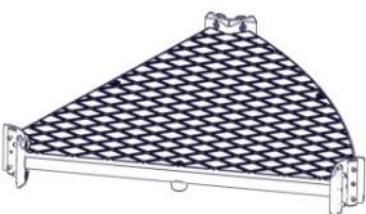
Sign. _____

Thorium Tårn-del2 07-302-223	Navn	Artnr/dimensjon	Ant	Lev
	Plast rørfeste	05-301-036	10	
	Plast rørfeste endelokk	05-301-036	10	
	Skive M8 stor	04-055-008	10	
	Møbelknapp M8x11	04-030-011	10	
	Gulv 3-kant 2 Rett CC880 Grå	07-300-108K (se egen del- montering)	1	
	Låsebolt M8x50	04-081-050	4	

14-200-Tårn del2 er helt like som den,
laget til å forenkle Bemet system
17.09.2024 MNO