

N**Monteringsanvisning****EN****Assembly Instructions****S****Monteringsanvisning**

Produkt nr. / Product no. / Produkt nr.

07-303-125K**Grotto**

Ord. nr. _____

Dato. _____

Sign. _____

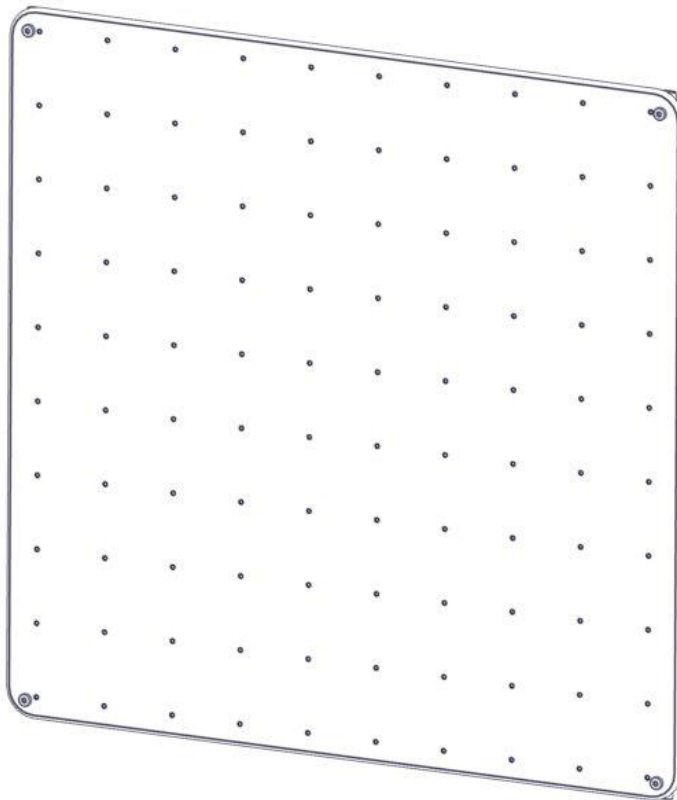
**sove**



Søve AS
Grønnvoldveien 290
3830 Ulefoss - Norway
Tlf: +47 35 94 65 65
www.sove.no

**sove**

Søve AB
EA Rosengrensgatan 32
421 31 Västra Frölunda
Phone: +46 (0)31 773 97 00
www.sove.se

Boltepakker for / Boltpackage for / Bultpaket för

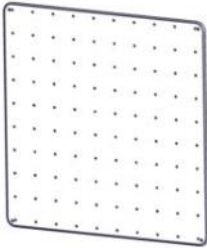
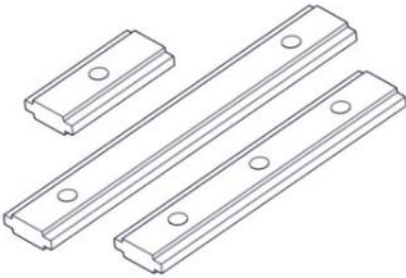
Sign. _____

KubHus vegg innvendi top 07-303-125K	Navn	Artnr/ dimensjon	Ant	Lev
	KubHus vegg innvendig top Grotto	07-303-125	1	
	Brikke 50 1xM8	04-060-050	4	
	Torx M8x30	04-000-030	4	

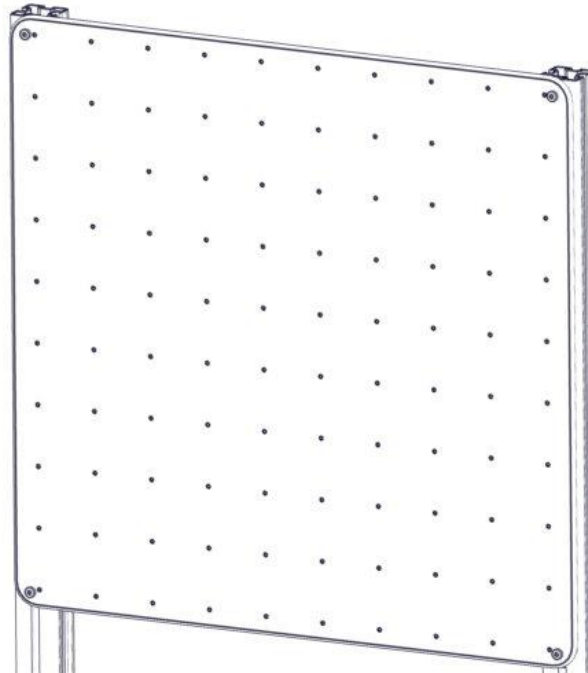

Montering av lekeapparatet / Assembly instructions / Montering av lekredskapet

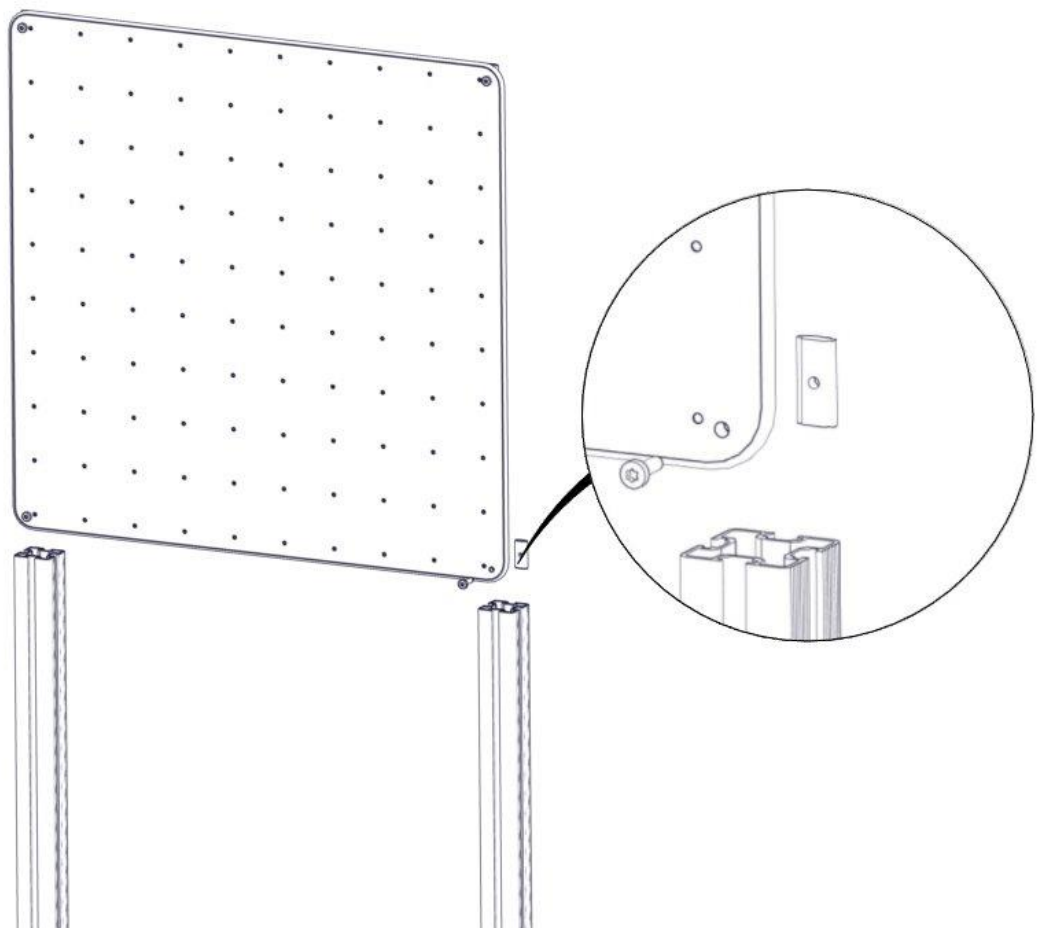
Part Name	Article nr.	Qty
Torx M8x30	04-000-030	4
Brikke 50 1XM8	04-060-050	4
KubHus vegg innvendig top	07-303-125	1

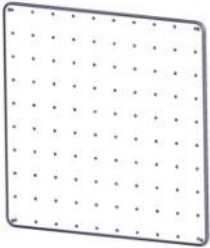
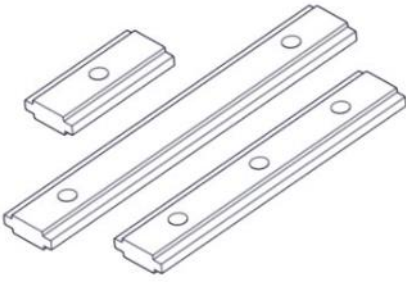

Boltepakker for / Boltpackage for / Bultpaket för

Sign. _____.

KubHus vegg innvendi top 07-303-125K	Navn	Artnr/ dimensjon	Ant	Lev
	KubHus vegg innvendig top Grotto	07-303-125	1	
	Brikke 50 1xM8	04-060-050	4	
	Torx M8x30	04-000-030	4	