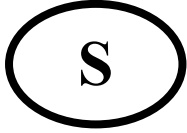

**Monteringsanvisning****Assembly Instructions****Monteringsanvisning**

Produkt nr. / Product no. / Produkt nr.

**07-303-126K****Gul**

Ord. nr. \_\_\_\_\_

Dato. \_\_\_\_\_

Sign. \_\_\_\_\_

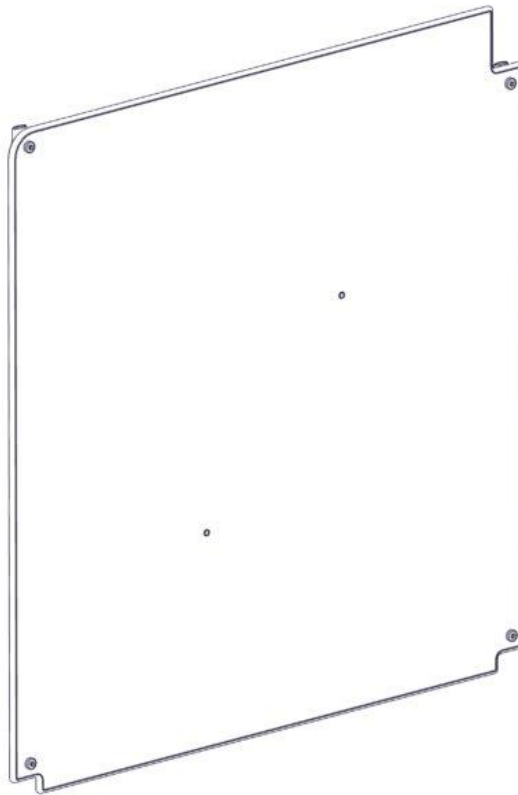
**søve**



Søve AS  
Grønnvoldveien 290  
3830 Ulefoss - Norway  
Tlf: +47 35 94 65 65  
[www.sove.no](http://www.sove.no)

**søve**

Søve AB  
EA Rosengrensgatan 32  
421 31 Västra Frölunda  
Phone: +46 (0)31 773 97 00  
[www.sove.se](http://www.sove.se)

**Boltepakker for / Boltpackage for / Bultpaket för**

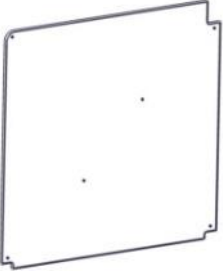
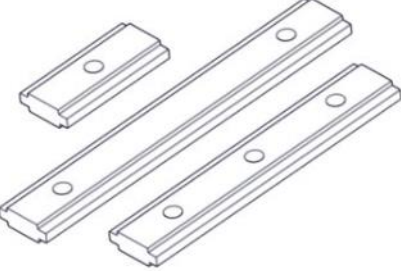
Sign. \_\_\_\_\_.

KubHus vegg venstre oppgang 07-303-126K	Navn	Artnr/ dimensjon	Ant	Lev
	KubHus vegg venstre oppgang Gul	07-303-126	1	
	Brikke 50 1xM8	04-060-050	4	
	Torx M8x30	04-000-030	4	

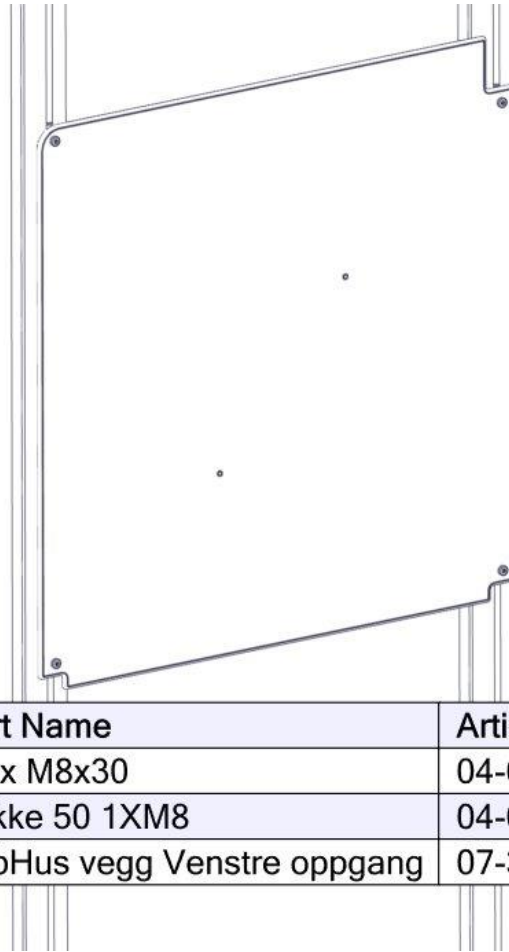
**Montering av lekeapparatet / Assembly instructions / Montering av lekredskapet**

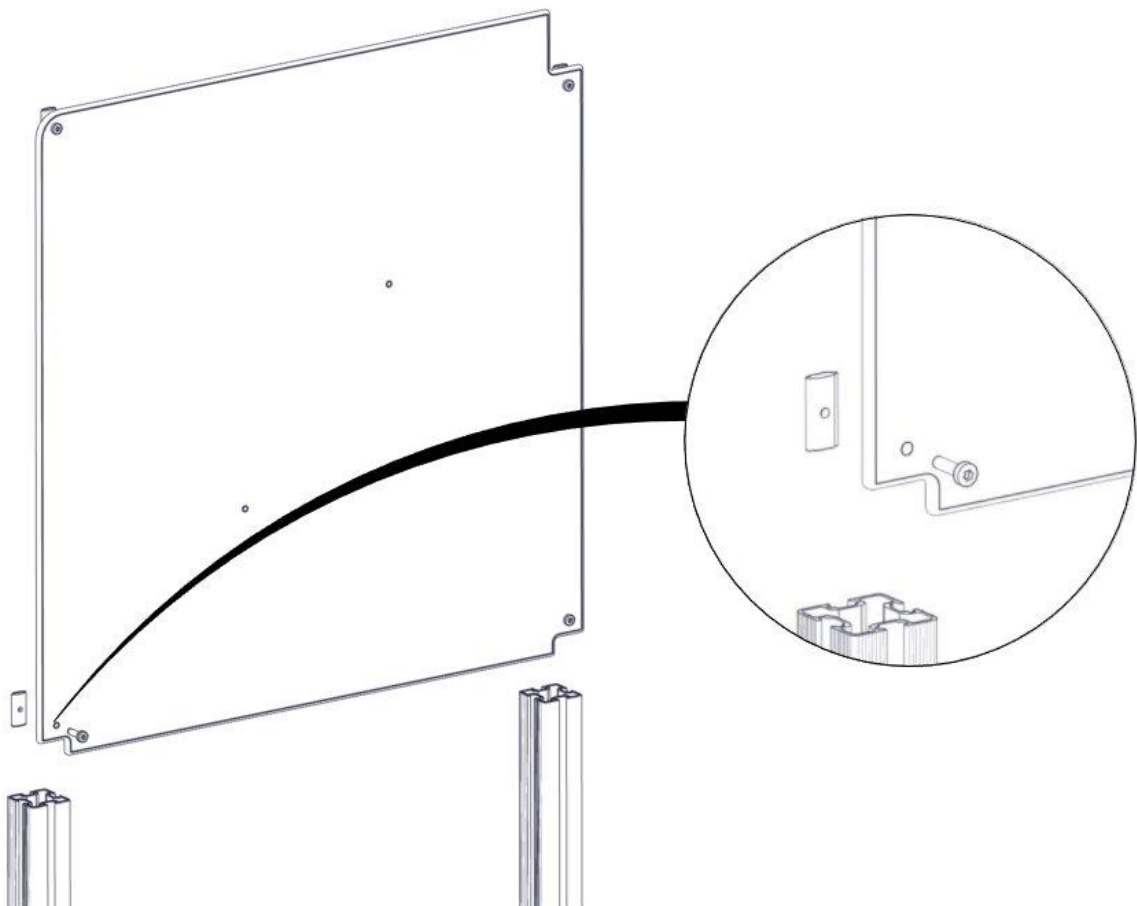

Part Name	Article nr.	Qty
Torx M8x30	04-000-030	4
Brikke 50 1XM8	04-060-050	4
KubHus vegg Venstre oppgang	07-303-126	1



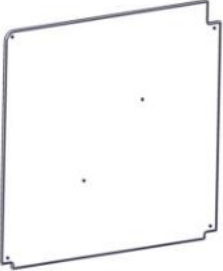
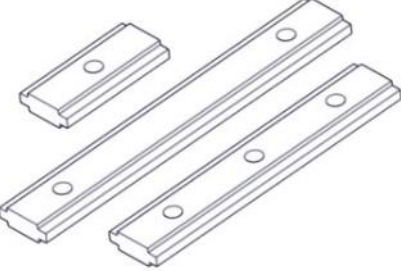

**Boltepakker for / Boltpackage for / Bultpaket för**

Sign. \_\_\_\_\_

KubHus vegg venstre oppgang 07-303-126K	Navn	Artnr/ dimensjon	Ant	Lev
	KubHus vegg venstre oppgang Gul	07-303-126	1	
	Brikke 50 1xM8	04-060-050	4	
	Torx M8x30	04-000-030	4	