

N

**Monteringsanvisning**

EN

**Assembly Instructions**

S

**Monteringsanvisning**

Produkt nr. / Product no. / Produkt nr.

**07-500-042K****Rød**

Ord. nr. \_\_\_\_\_

Dato. \_\_\_\_\_

Sign. \_\_\_\_\_

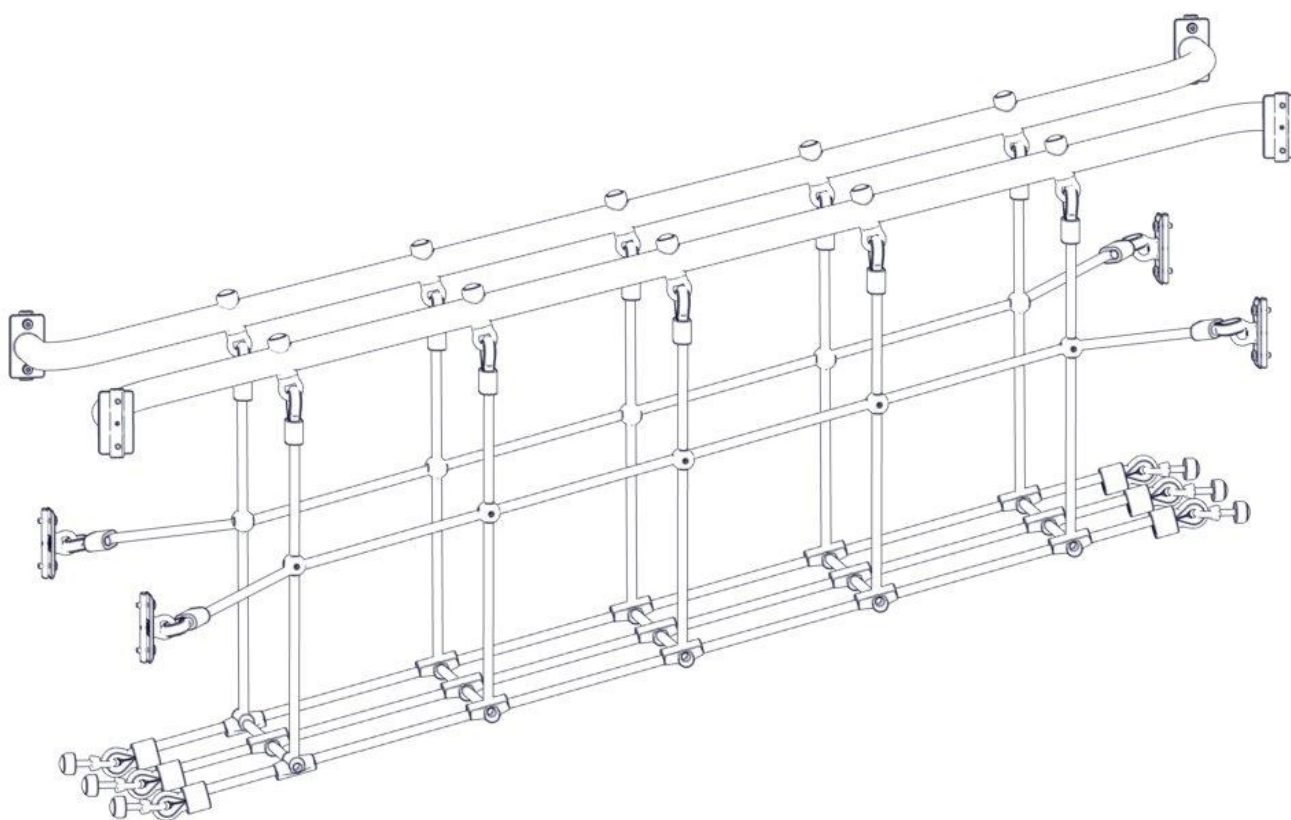
**søve**





Søve AS  
 Grønnvoldveien 290  
 3830 Ulefoss - Norway  
 Tlf: +47 35 94 65 65  
 www.sove.no

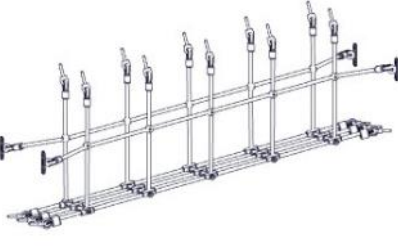

**søve**

Søve AB  
 EA Rosengrensgatan 32  
 421 31 Västra Frölunda  
 Phone: +46 (0)31 773 97 00  
 www.sove.se

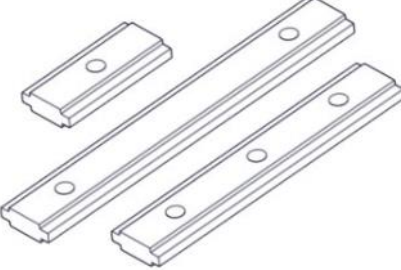
**Boltepakker for / Boltpackage for / Bultpaket för**

Sign. \_\_\_\_\_

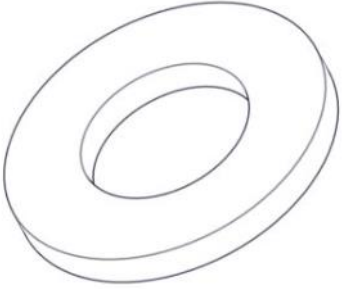
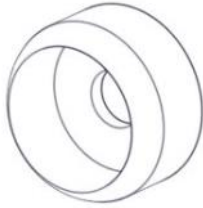
| Nettbru skrå 11- serie kompl<br>07-500-042K   | Navn  | Artnr/dimensjon | Ant | Lev |
|---|---|-----------------|-----|-----|
|    | Nettbru Skrå 11-serie<br>Rød                              | 07-500-043      | 1   |     |
|    | Rør bøyd til bro skrå<br>Ø48,3 CC=2075<br>Venstre<br>Sort | 07-200-025      | 1   |     |
|   | Rør bøyd til bro skrå<br>Ø48,3 CC2075<br>Høyre<br>Sort    | 07-200-026      | 1   |     |
|  | Brikke 120 3xM8   | 04-060-120      | 8   |     |
|  | Torx M8x25  | 04-000-025      | 16  |     |
|  | Låsemutter M10  | 04-040-010      | 16  |     |

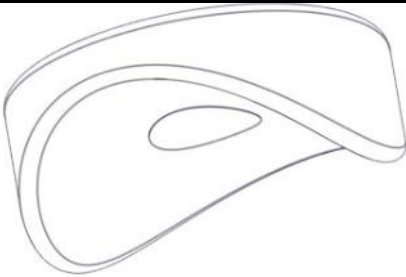
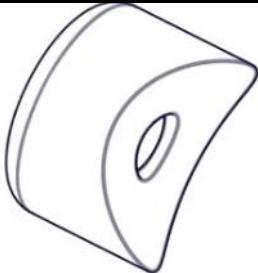
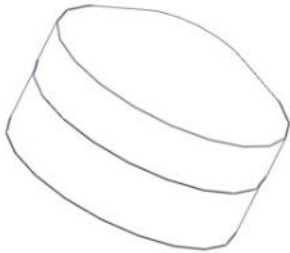
| <b>Boltepakker for / Boltpackage for / Bultpaket för</b>                            |  | Sign. _____            |            |            |
|---|--|------------------------|------------|------------|
| <b>Nettbru skrå 11- serie kompl<br/>07-500-042K</b>                                 | <b>Navn</b>                                | <b>Artnr/dimensjon</b> | <b>Ant</b> | <b>Lev</b> |
|    | Skive M8                                   | 04-050-008             | 8          |            |
|   | Skive M10 polyfix                          | 04-055-036             | 16         |            |
|    | Endedeksel flat<br>M10/12<br>Kropp<br>Sort | 05-301-035             | 6          |            |
|   | Endedeksel flat<br>M10/12<br>Hode<br>Sort  | 05-301-035             | 6          |            |
|  | Avstandsskive<br>Radie 38<br>Sort          | 04-210-010             | 10         |            |
|  | Plast rørfeste<br>M10/12<br>Kropp<br>Sort  | 05-301-036             | 10         |            |
|  | Plast rørfeste<br>M10/12<br>Hode<br>Sort   | 05-301-036             | 10         |            |

## Montering av lekeapparatet / Assembly instructions / Montering av lekredskapet

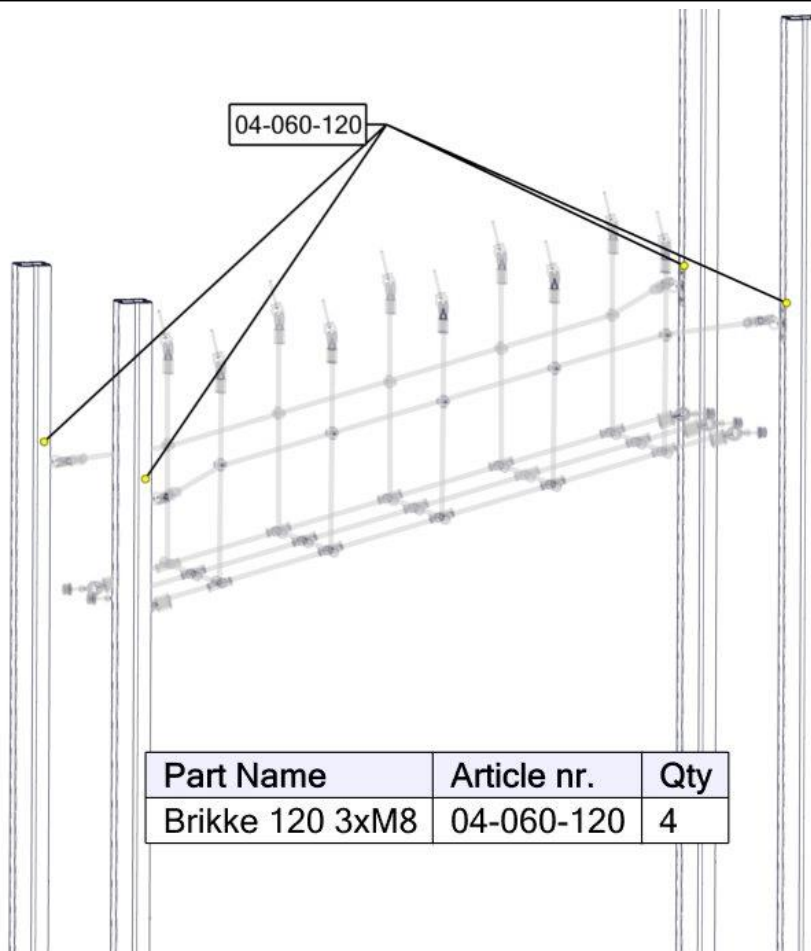

| Part Name       | Article nr. | Qty |
|-----------------|-------------|-----|
| Brikke 120 3xM8 | 04-060-120  | 4   |

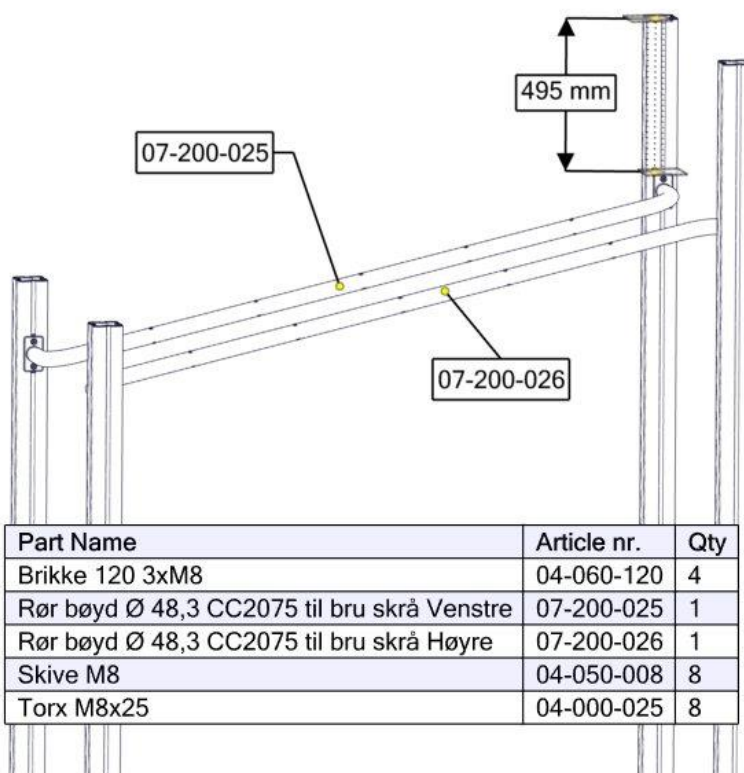

| Part Name                                   | Article nr. | Qty |
|---|-------------|-----|
| Brikke 120 3xM8                             | 04-060-120  | 4   |
| Rør bøyd Ø 48,3 CC2075 til bru skrå Venstre | 07-200-025  | 1   |
| Rør bøyd Ø 48,3 CC2075 til bru skrå Høyre   | 07-200-026  | 1   |
| Skive M8                                    | 04-050-008  | 8   |
| Torx M8x25                                  | 04-000-025  | 8   |

## Montering av lekeapparatet / Assembly instructions / Montering av lekredskapet

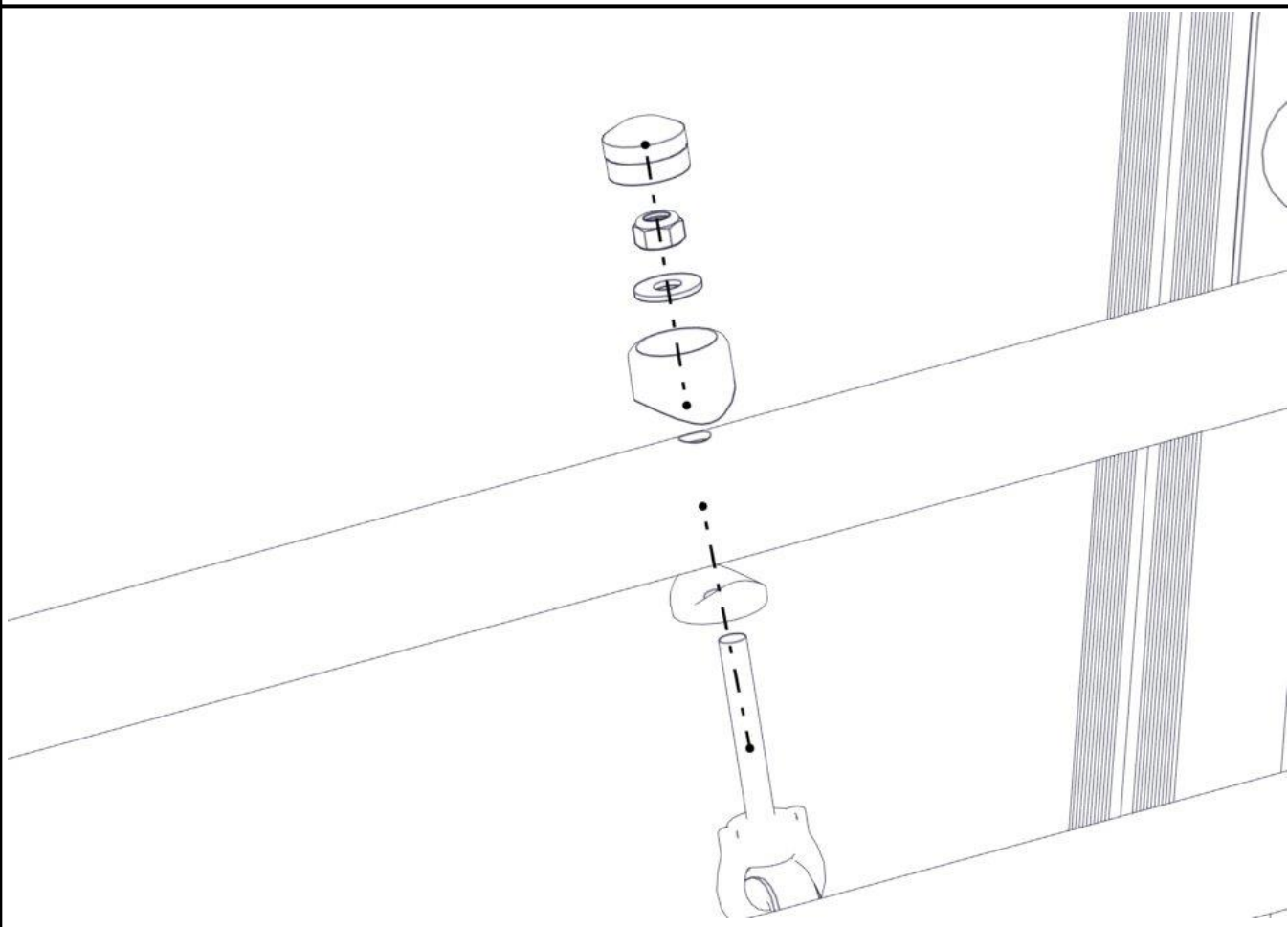
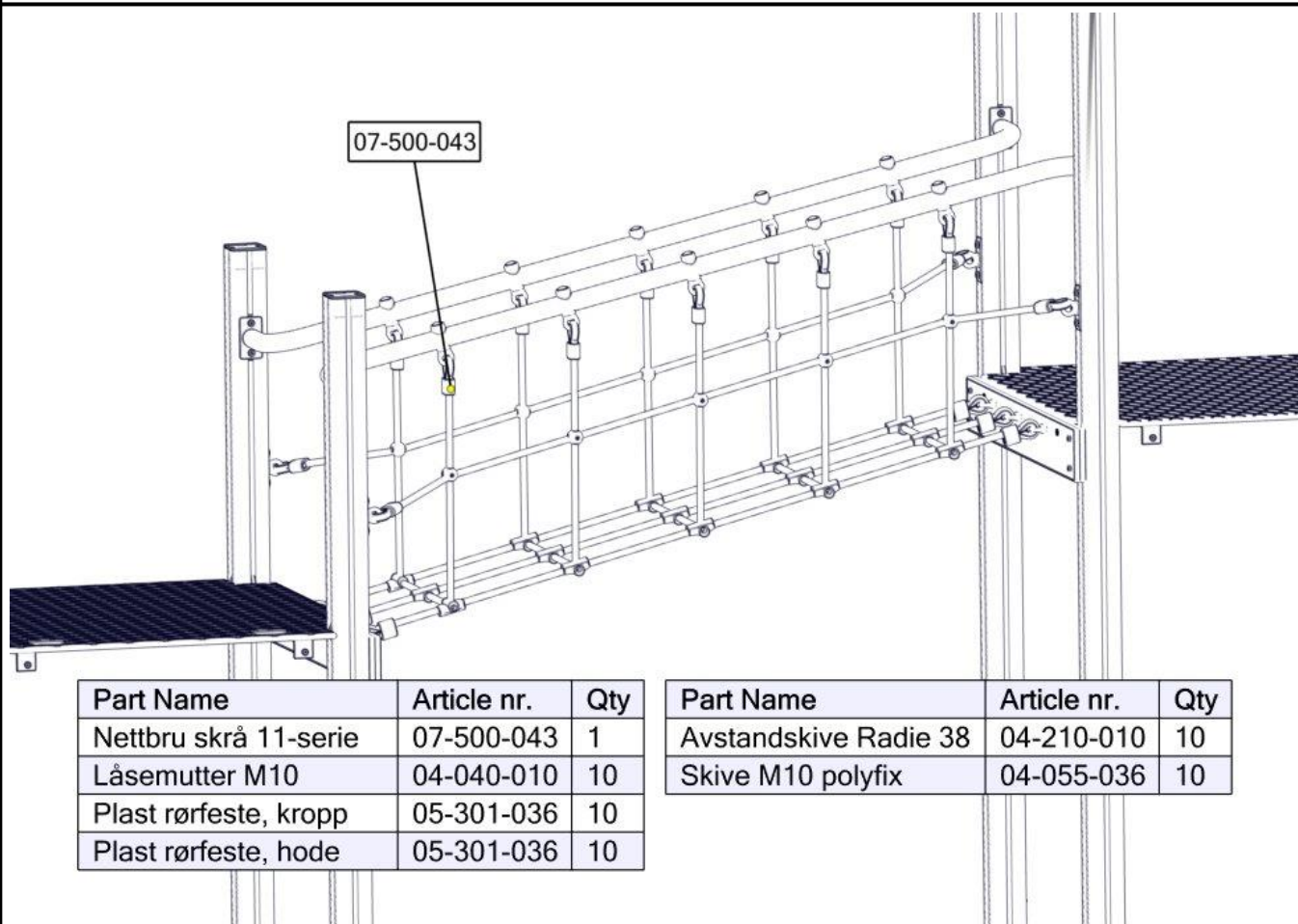





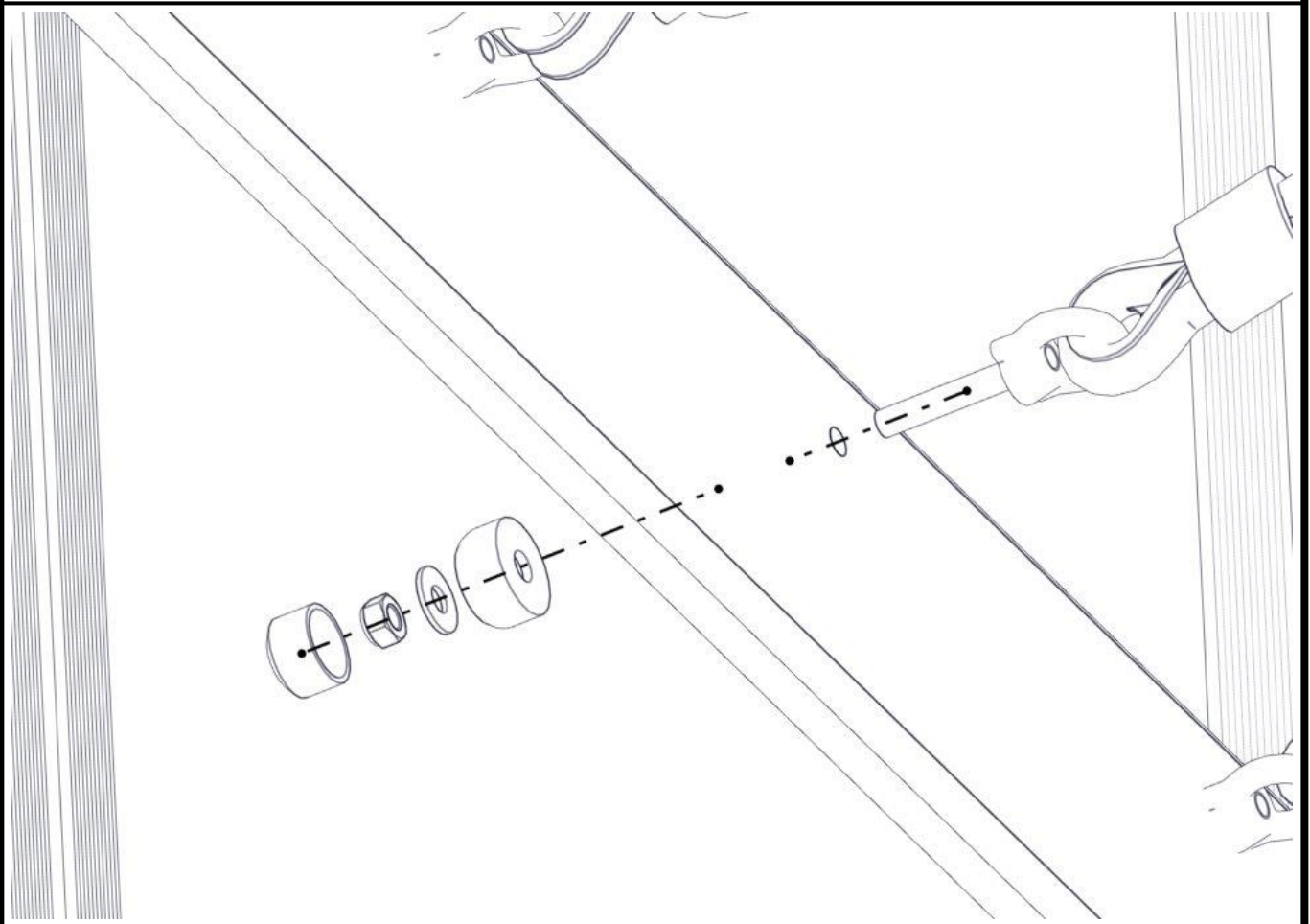
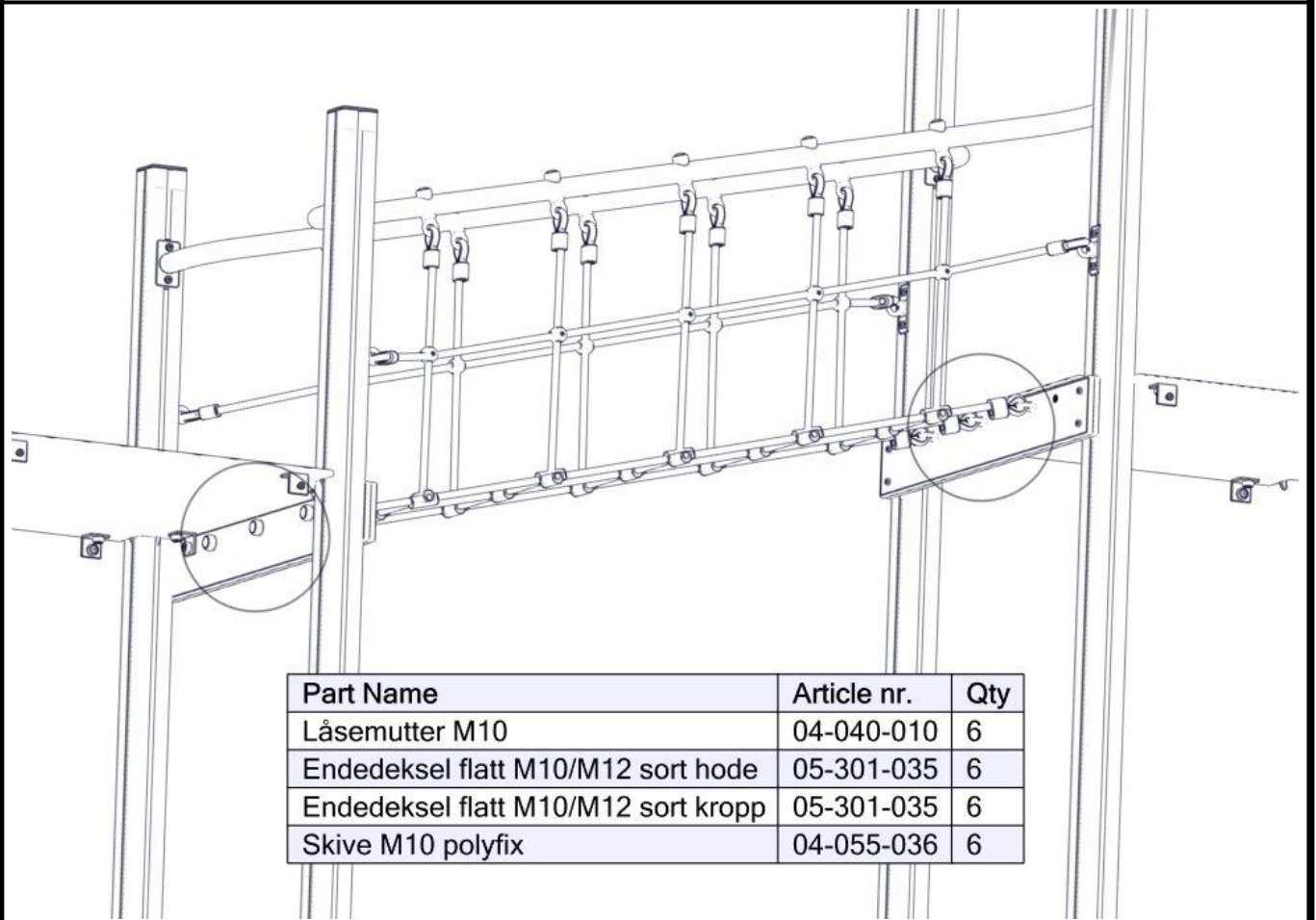

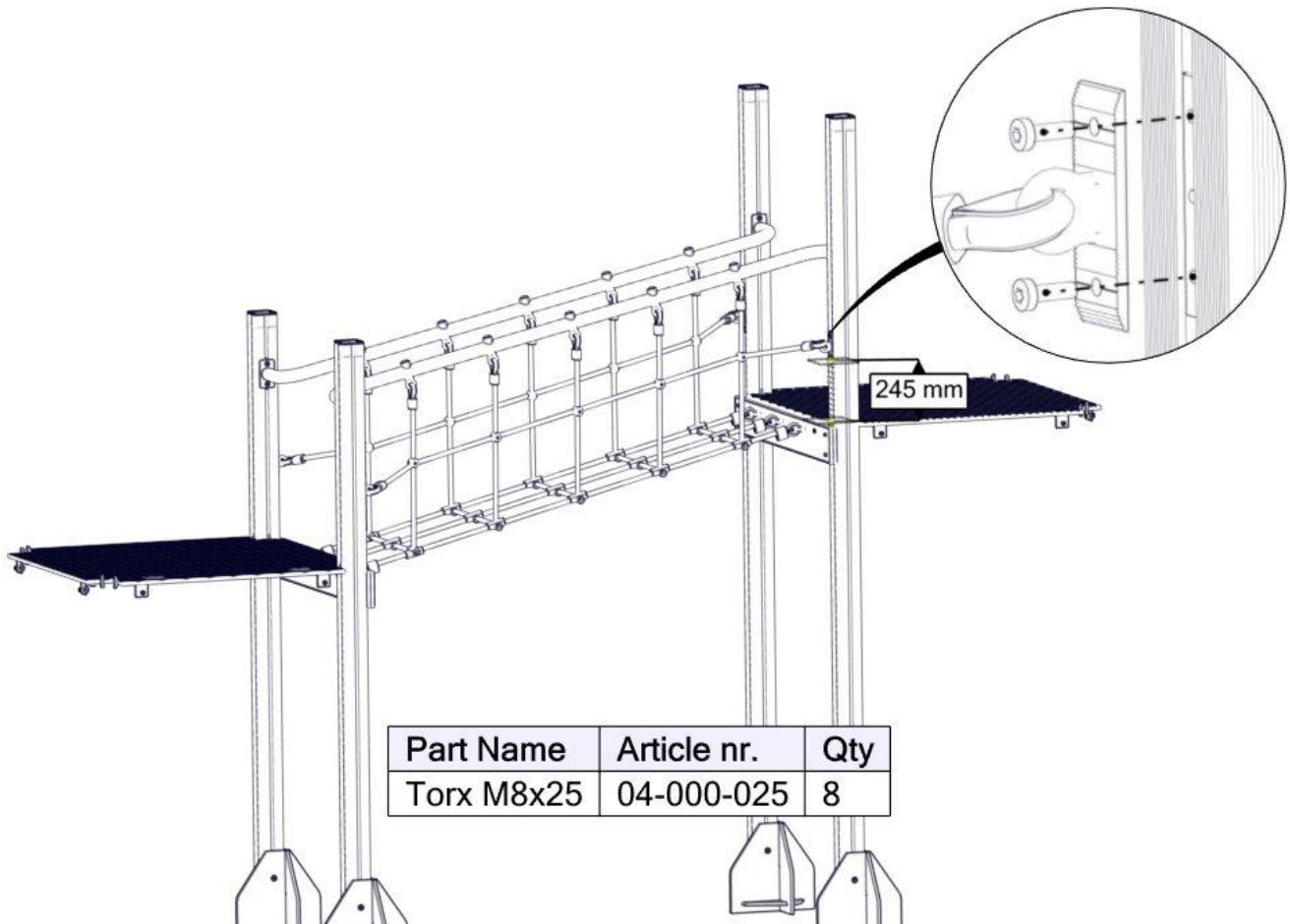
## Montering av lekeapparatet / Assembly instructions / Montering av lekredskapet



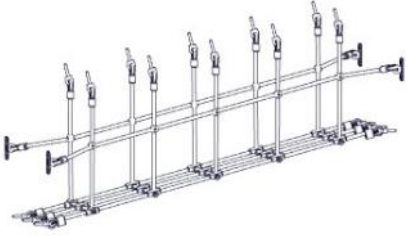

**Montering av lekeapparatet / Assembly instructions / Montering av lekredskapet**

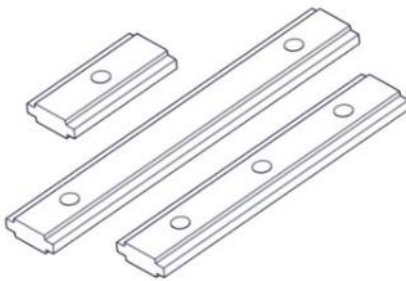

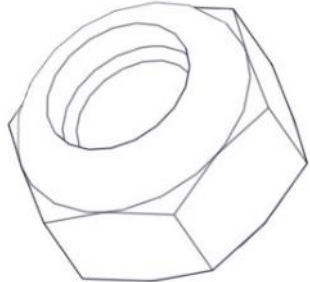

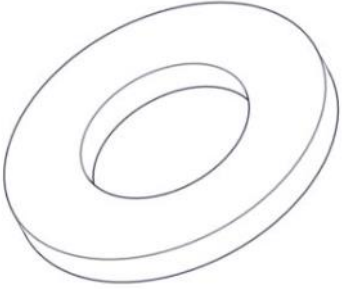
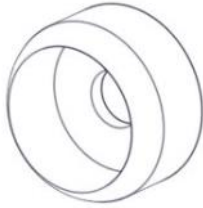
| <b>Boltepakker for / Boltpackage for / Bultpaket för</b>                            |   | Sign. _____            |            |            |
|---|---|------------------------|------------|------------|
| <b>Nettbru skrå 11- serie kompl<br/>07-500-042K</b>                                 | <b>Navn</b>   | <b>Artnr/dimensjon</b> | <b>Ant</b> | <b>Lev</b> |
|    | Nettbru Skrå 11-serie<br>Rød                              | 07-500-043             | 1          |            |
|    | Rør bøyd til bro skrå<br>Ø48,3 CC=2075<br>Venstre<br>Sort | 07-200-025             | 1          |            |
|   | Rør bøyd til bro skrå<br>Ø48,3 CC2075<br>Høyre<br>Sort    | 07-200-026             | 1          |            |
|  | Brikke 120 3xM8   | 04-060-120             | 8          |            |
|  | Torx M8x25  | 04-000-025             | 16         |            |
|  | Låsemutter M10  | 04-040-010             | 16         |            |

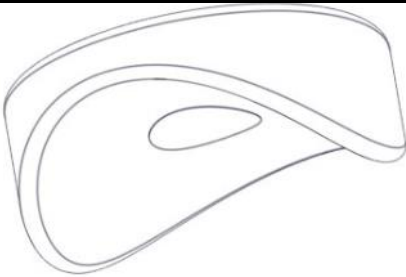
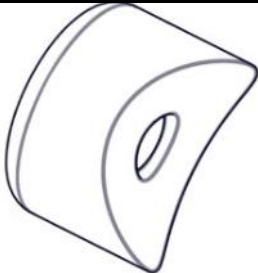
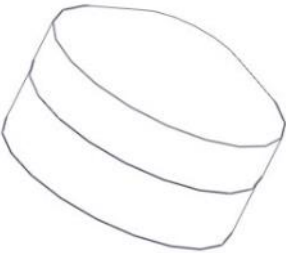
| <b>Boltepakker for / Boltpackage for / Bultpaket för</b>                            |  | Sign. _____            |            |            |
|---|--|------------------------|------------|------------|
| <b>Nettbru skrå 11- serie kompl<br/>07-500-042K</b>                                 | <b>Navn</b>                                | <b>Artnr/dimensjon</b> | <b>Ant</b> | <b>Lev</b> |
|    | Skive M8                                   | 04-050-008             | 8          |            |
|   | Skive M10 polyfix                          | 04-055-036             | 16         |            |
|    | Endedeksel flat<br>M10/12<br>Kropp<br>Sort | 05-301-035             | 6          |            |
|   | Endedeksel flat<br>M10/12<br>Hode<br>Sort  | 05-301-035             | 6          |            |
|  | Avstandsskive<br>Radie 38<br>Sort          | 04-210-010             | 10         |            |
|  | Plast rørfeste<br>M10/12<br>Kropp<br>Sort  | 05-301-036             | 10         |            |
|  | Plast rørfeste<br>M10/12<br>Hode<br>Sort   | 05-301-036             | 10         |            |

Revidert  
11-03-2020  
Korrigert art.nr for skrå nettbru

MTK 11-12-2020  
Sett in label på rør og endre pluklsit  
07-200-025 er venster rør 207-200-026 er høyre rør