

N**Monteringsanvisning****EN****Assembly Instructions****S****Monteringsanvisning**

Produkt nr. / Product no. / Produkt nr.

07-500-290K**Rød**

Ord. nr. _____

Dato. _____

Sign. _____

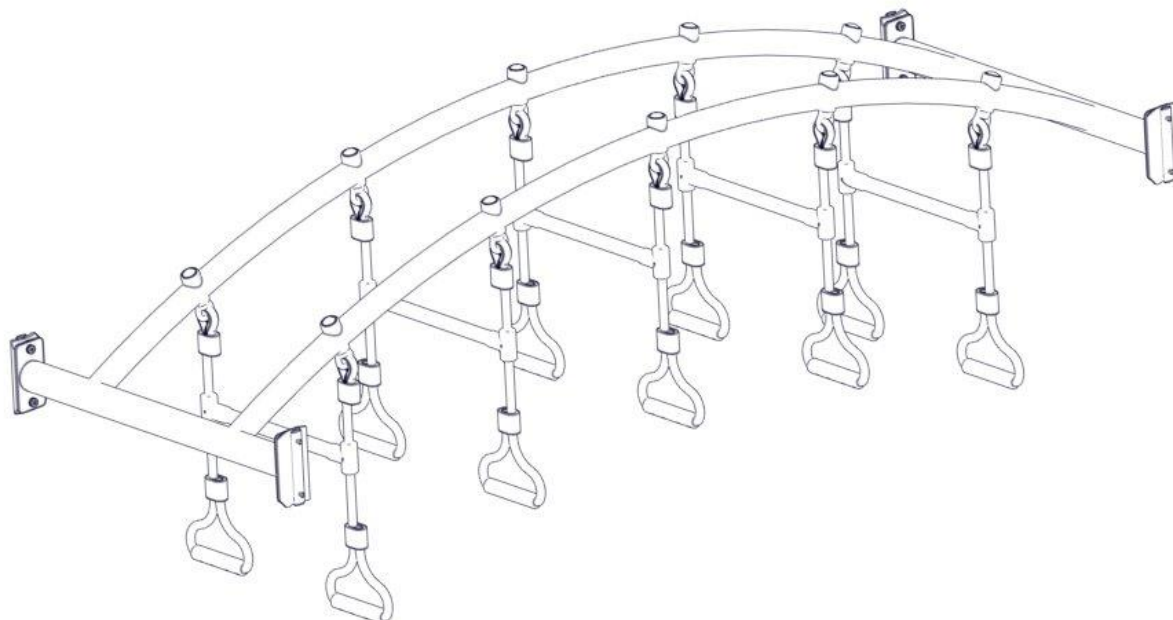





Søve AS
Grønnvoldveien 290
3830 Ulefoss - Norway
Tlf: +47 35 94 65 65
www.sove.no



Søve AB
EA Rosengrensgatan 32
421 31 Västra Frölunda
Phone: +46 (0)31 773 97 00
www.sove.se

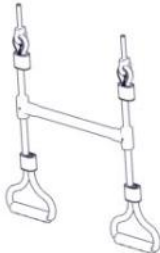

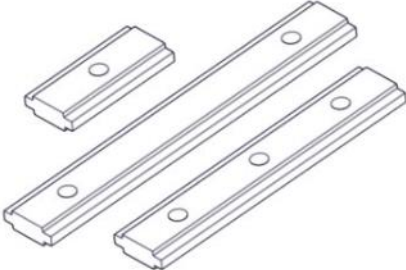
Boltepakker for / Boltpackage for / Bultpaket för

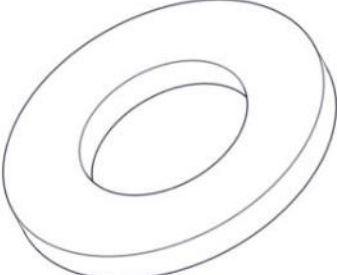
Sign. _____

Bru med ringer 07-500-290K	Navn	Artnr/dimensjon	Ant	Lev
	Bro dobbelt ringer CC880 Rød	07-500-291	1	
	Ringer Sort	07-500-292	5	
	Torx M8x35	04-000-035	8	
	Brikke 150 2xM8	04-060-151	4	
	Beslag 0gr L=150 2xhull	07-150-022	4	
	Skive M8 Skive M10 polyfix	04-050-008 04-055-036	8 10	

Boltepakker for / Boltpackage for / Bultpaket för

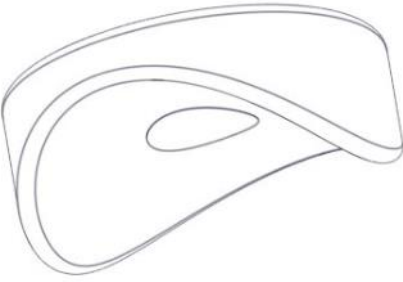
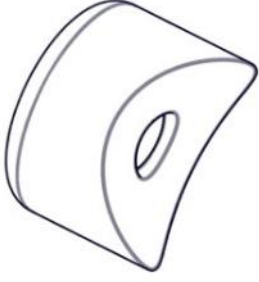
Sign. _____.

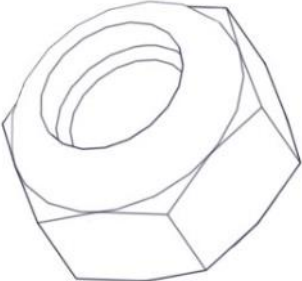
Bru med ringer 07-500-290K	Navn	Artnr/dimensjon	Ant	Lev
	Avstandskive for Ø38	04-210-010	10	
	Plast rørfeste kropp	05-301-036	10	
	Plast rørfeste topp	05-301-036	10	
	Låsemutter M10	04-040-010	10	

Montering av lekeapparatet / Assembly instructions / Montering av lekredskapet

Se på hovedmontering for posisjon
 Look at main assembly for position
 Titta på hovudmontering för position

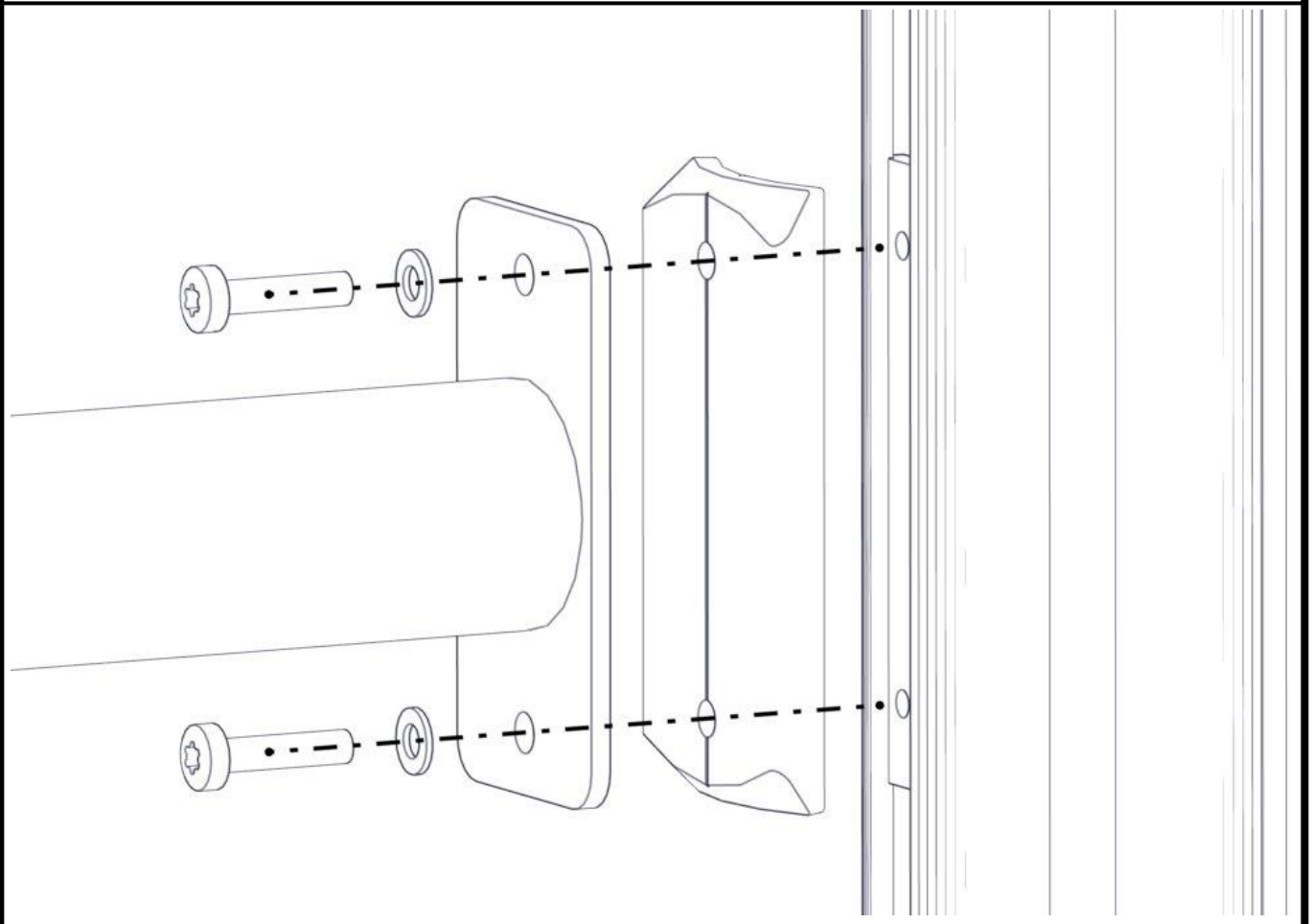
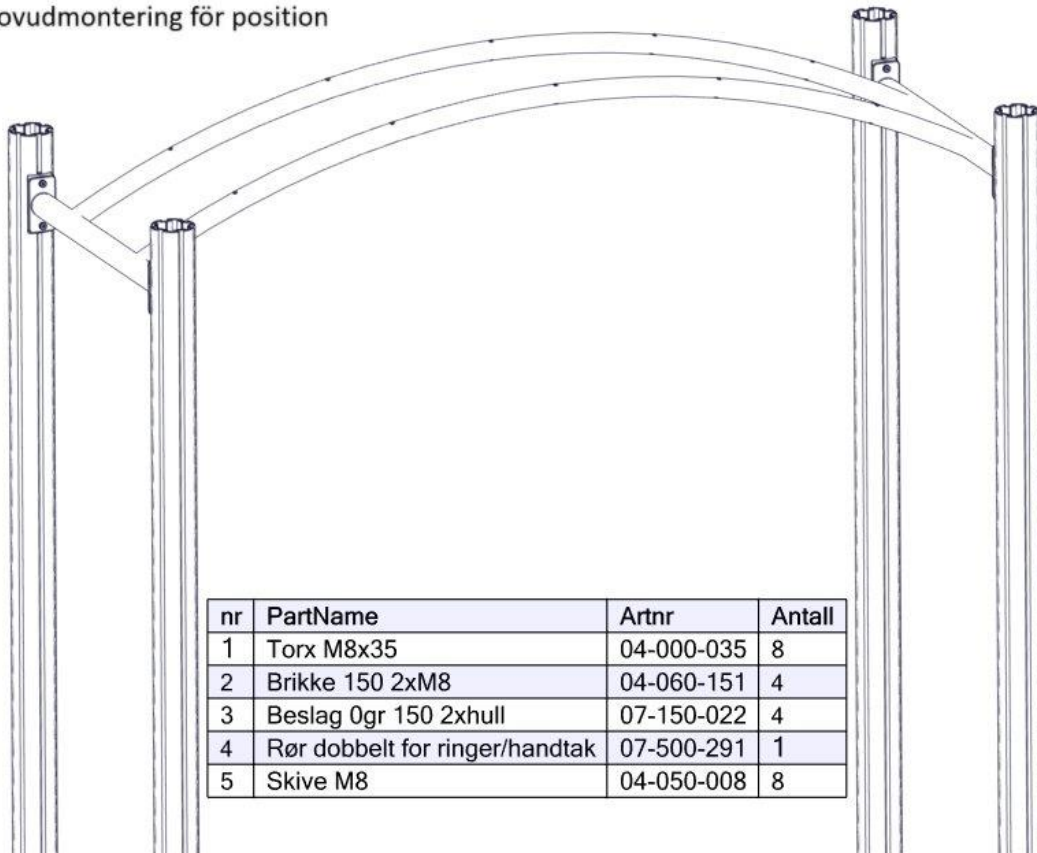

Montering av lekeapparatet / Assembly instructions / Montering av lekredskapet

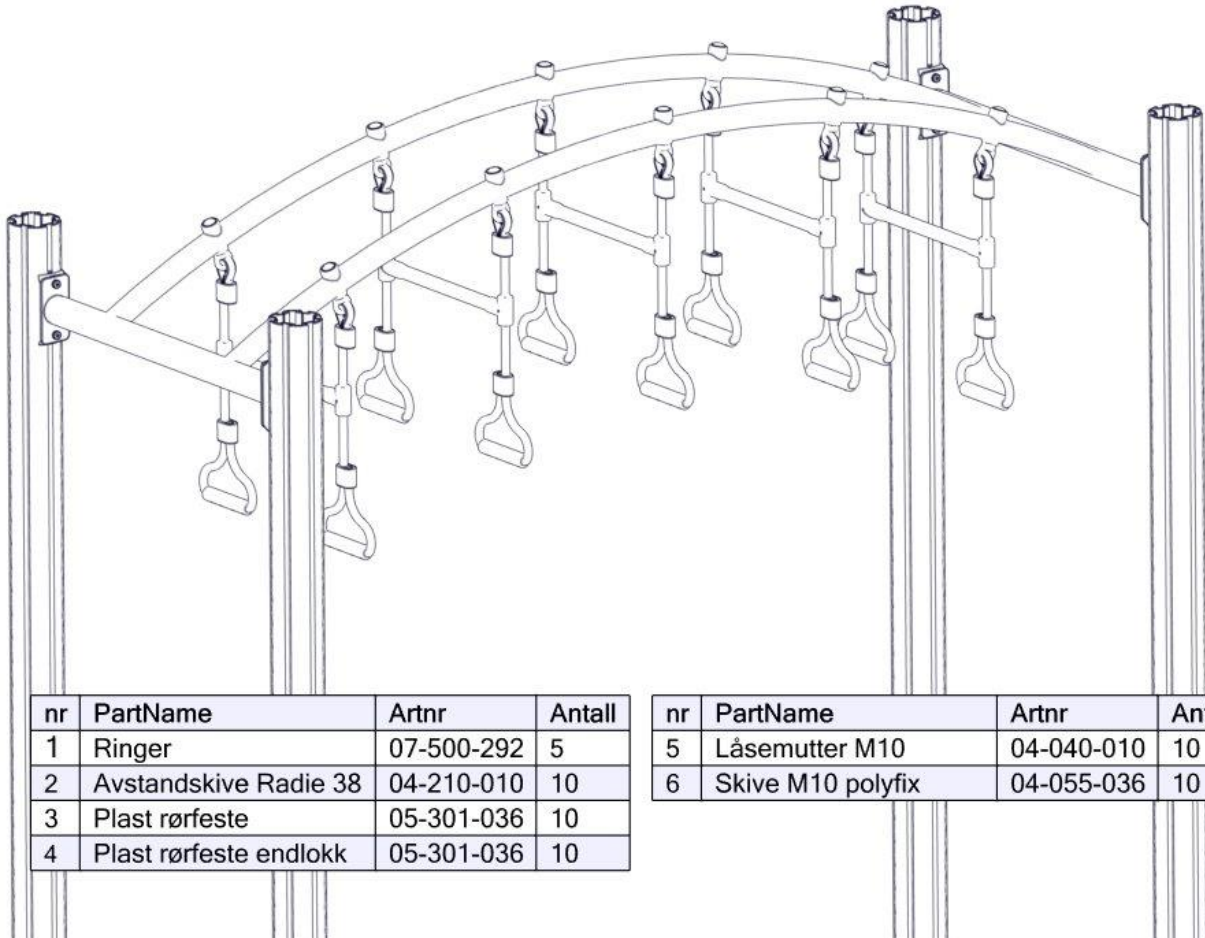



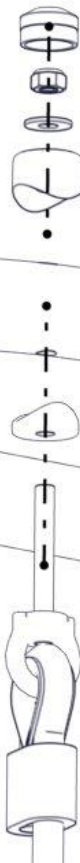

nr	PartName	Artnr	Antall
1	Ringer	07-500-292	5
2	Avstandskive Radie 38	04-210-010	10
3	Plast rørfeste	05-301-036	10
4	Plast rørfeste endlokk	05-301-036	10

nr	PartName	Artnr	Antall
5	Låsemutter M10	04-040-010	10
6	Skive M10 polyfix	04-055-036	10



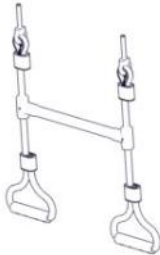

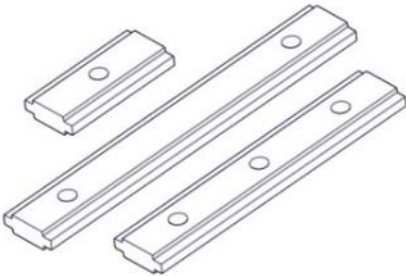
Boltepakker for / Boltpackage for / Bultpaket för

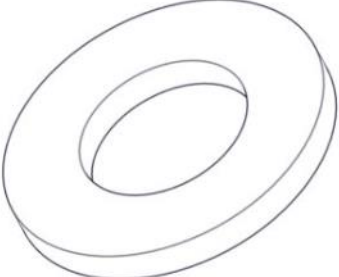
Sign. _____

Bru med ringer 07-500-290K	Navn	Artnr/dimensjon	Ant	Lev
	Bro dobbelt ringer CC880 Rød	07-500-291	1	
	Ringer Sort	07-500-292	5	
	Torx M8x35	04-000-035	8	
	Brikke 150 2xM8	04-060-151	4	
	Beslag 0gr L=150 2xhull	07-150-022	4	
	Skive M8 Skive M10 polyfix	04-050-008 04-055-036	8 10	

Boltepakker for / Boltpackage for / Bultpaket för

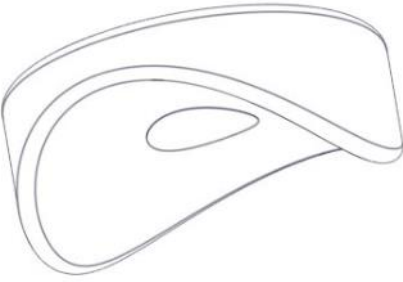
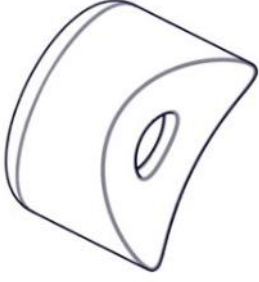
Sign. _____.

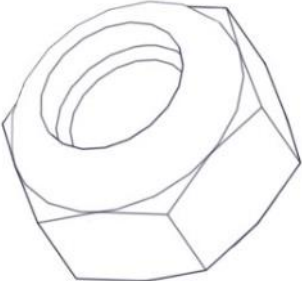
Bru med ringer 07-500-290K	Navn	Artnr/dimensjon	Ant	Lev
	Avstandskive for Ø38	04-210-010	10	
	Plast rørfeste kropp	05-301-036	10	
	Plast rørfeste topp	05-301-036	10	
	Låsemutter M10	04-040-010	10	