

N**Monteringsanvisning****EN****Assembly Instructions****S****Monteringsanvisning**

Produkt nr. / Product no. / Produkt nr.

07-500-295K**Sort**

Ord. nr. _____

Dato. _____

Sign. _____

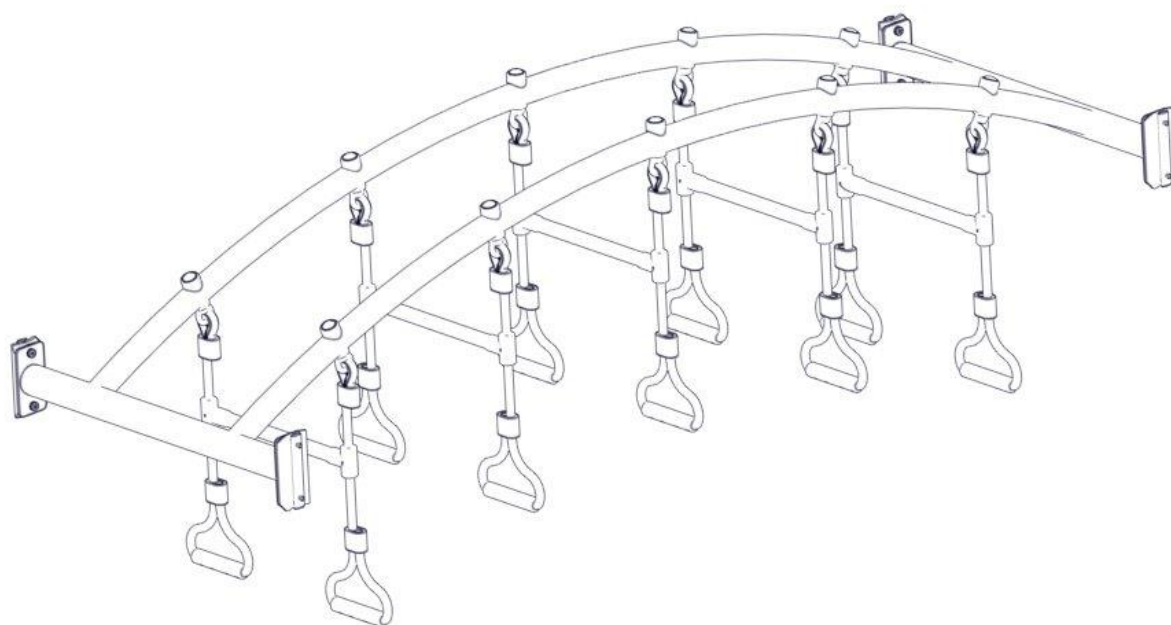
**søve**





Søve AS
Grønnvoldveien 290
3830 Ulefoss - Norway
Tlf: +47 35 94 65 65
www.sove.no

**søve**

Søve AB
EA Rosengrensgatan 32
421 31 Västra Frölunda
Phone: +46 (0)31 773 97 00
www.sove.se

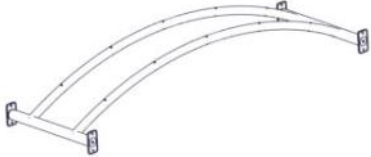
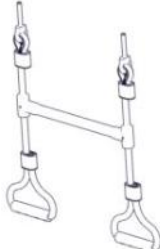
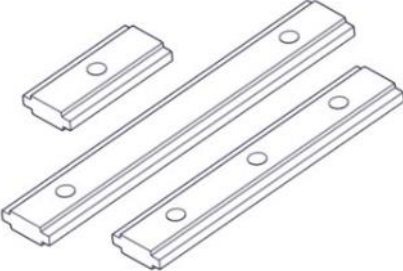

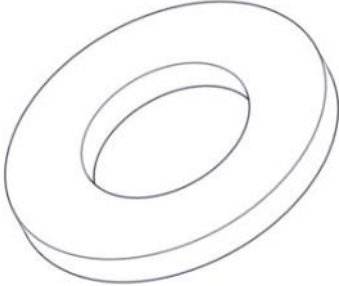
Boltepakker for / Boltpackage for / Bultpaket för

Sign. _____

Rør dbl for ringer Sort 07-500-295K	Navn	Artnr/dimensjon	Ant	Lev
	Rør dobbelt for ringer CC880 Sort	07-500-295	1	
	Ringer m/ plast trinn	07-500-292	5	
	Brikke 150 2xM8	04-060-151	4	
	Torx M8x35	04-000-035	8	
	Skive M8 Skive M10 polyfix	04-050-008 04-055-036	8 10	
	Beslag 0gr L=150 2x hull	07-150-022	4	

Boltepakker for / Boltpackage for / Bultpaket för

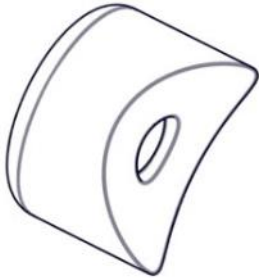
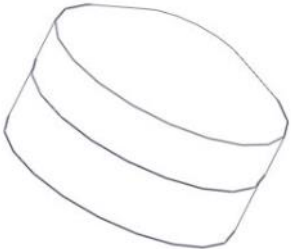
Sign. _____.

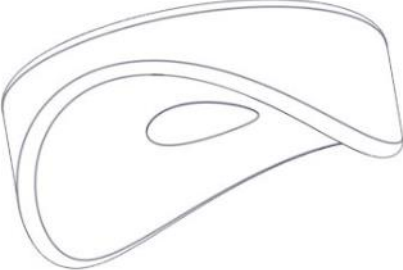
Rør dbl for ringer Sort 07-500-295K	Navn	Artnr/dimensjon	Ant	Lev
	Plast rørfeste	05-301-036	10	
	Plast rørfeste endelokk	05-301-036	10	
	Låsemutter M10	04-040-010	10	
	Avstandsskive til Ø38	04-210-010	10	

Montering av lekeapparatet / Assembly instructions / Montering av lekredskapet

Se på hovedmontering for posisjon
 Look at main assembly for position
 Titta på hovudmontering för position

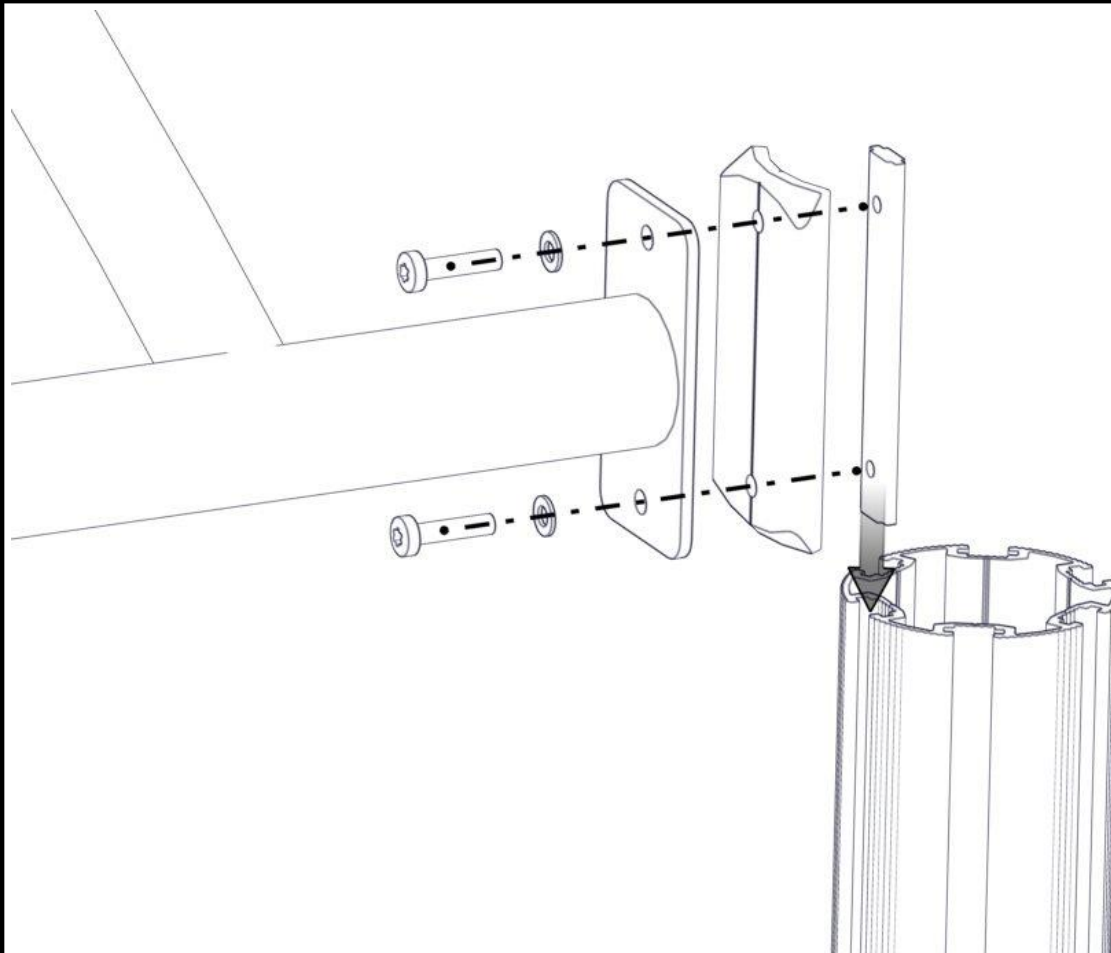
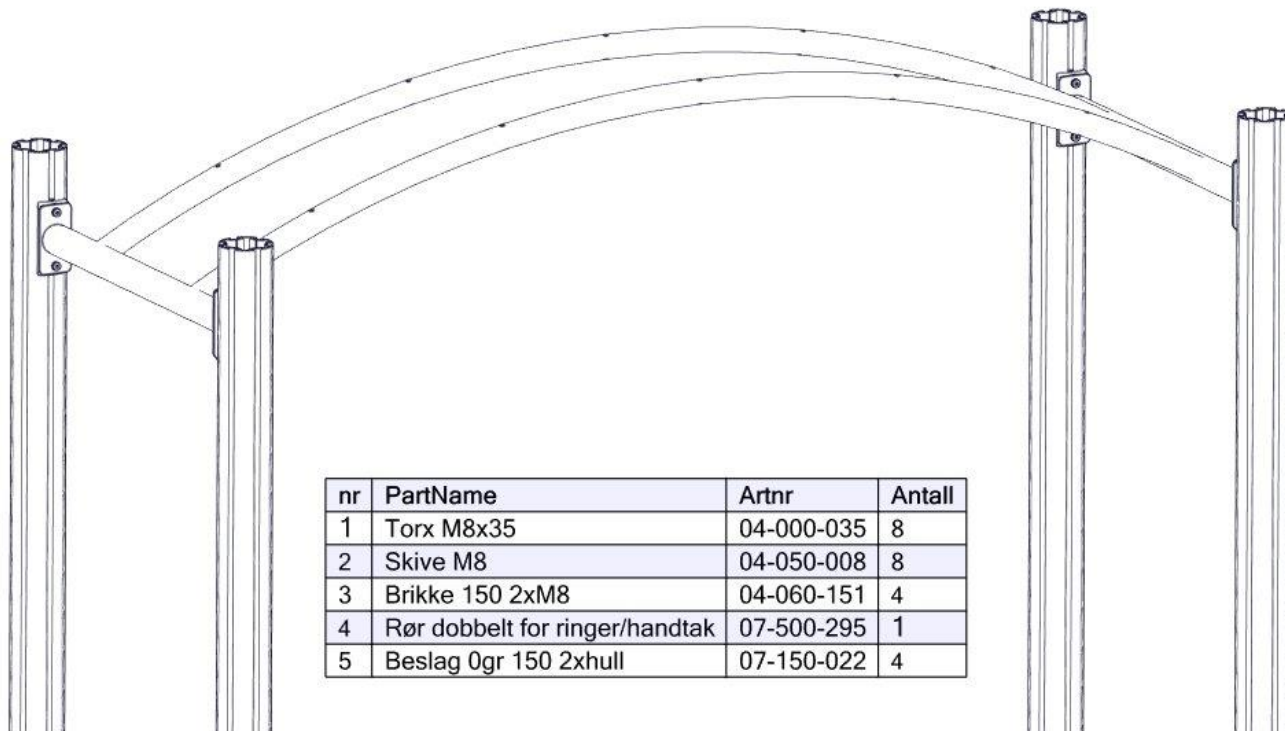



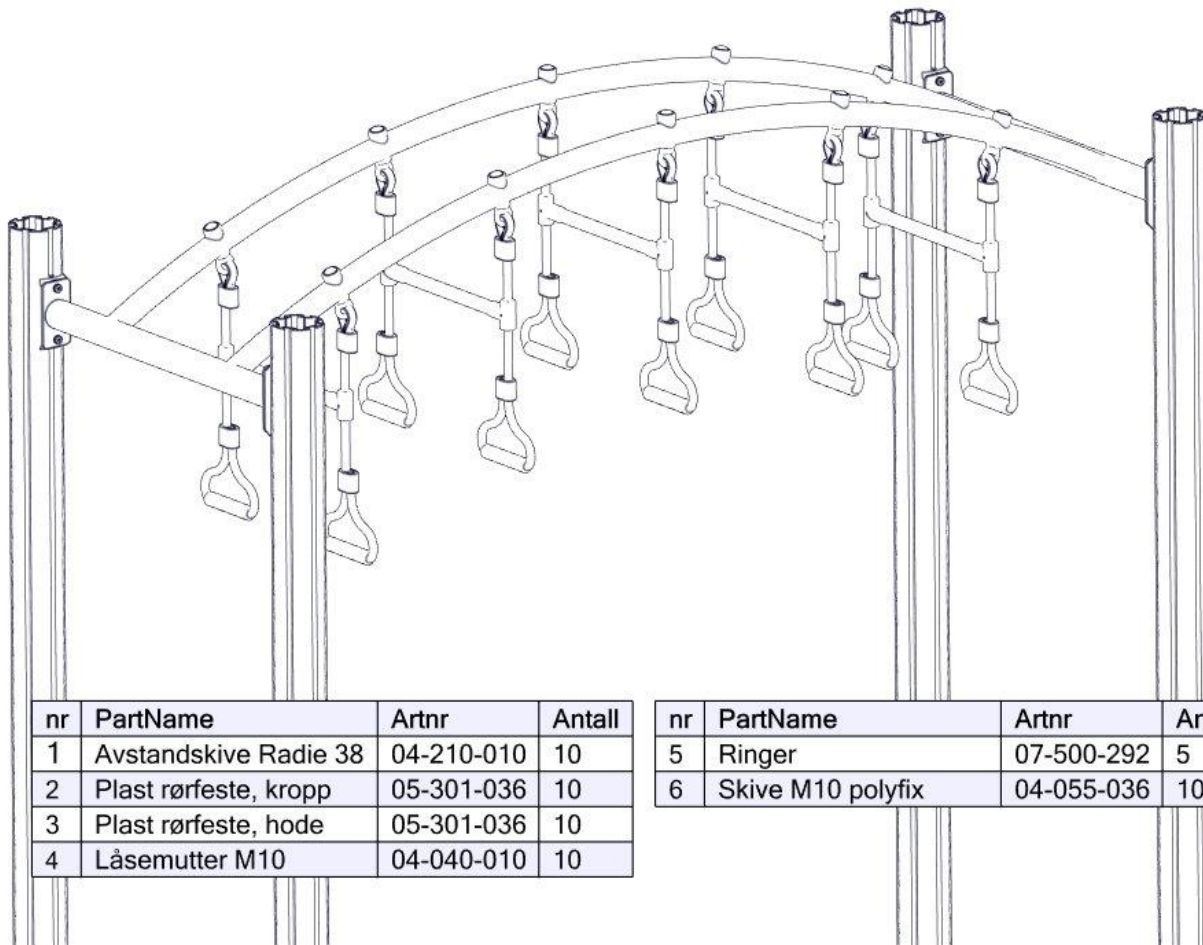

Montering av lekeapparatet / Assembly instructions / Montering av lekredskapet

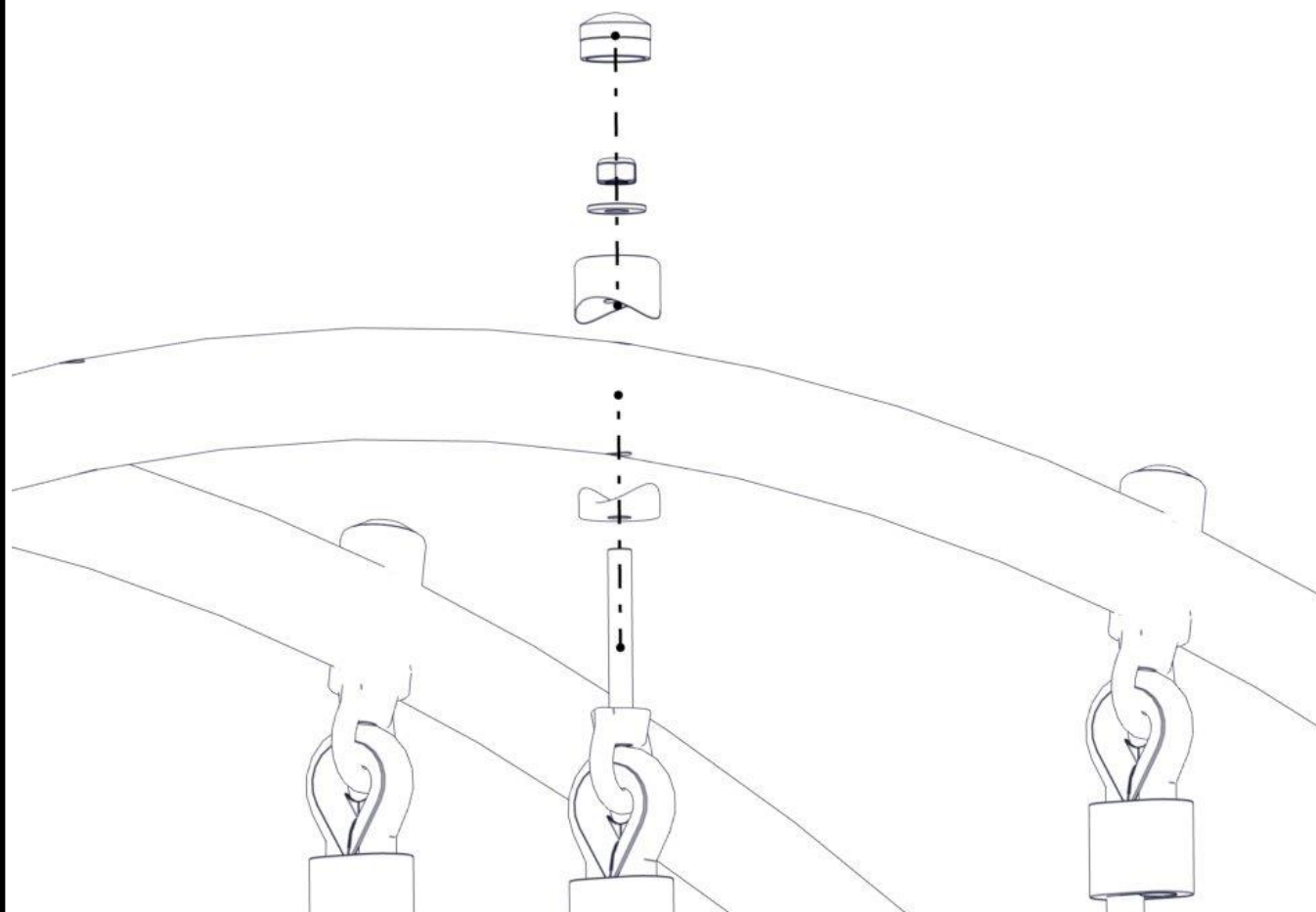

nr	PartName	Artnr	Antall
1	Avstandskive Radie 38	04-210-010	10
2	Plast rørfeste, kropp	05-301-036	10
3	Plast rørfeste, hode	05-301-036	10
4	Låsemutter M10	04-040-010	10

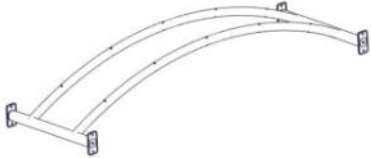
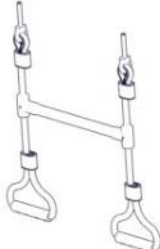
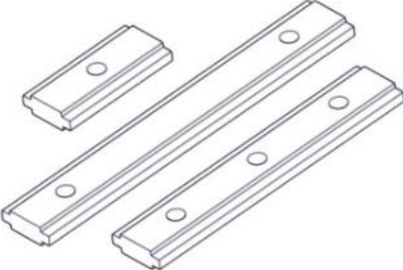

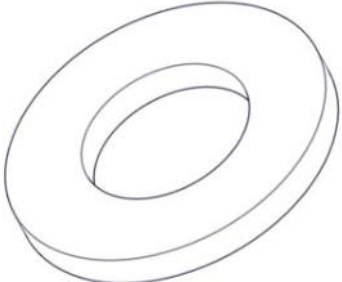
nr	PartName	Artnr	Antall
5	Ringer	07-500-292	5
6	Skive M10 polyfix	04-055-036	10



Boltepakker for / Boltpackage for / Bultpaket för		Sign. _____.		
Rør dbl for ringer Sort 07-500-295K	Navn	Artnr/dimensjon	Ant	Lev
	Rør dobbelt for ringer CC880 Sort	07-500-295	1	
	Ringer m/ plast trinn	07-500-292	5	
	Brikke 150 2xM8	04-060-151	4	
	Torx M8x35	04-000-035	8	
	Skive M8 Skive M10 polyfix	04-050-008 04-055-036	8 10	
	Beslag 0gr L=150 2x hull	07-150-022	4	

Boltepakker for / Boltpackage for / Bultpaket för

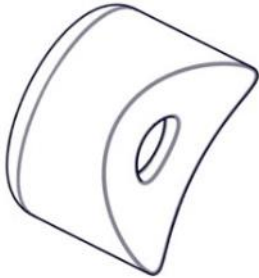
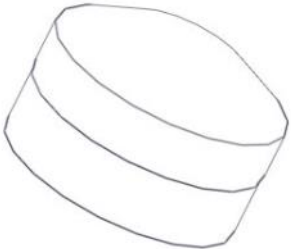
Sign. _____.

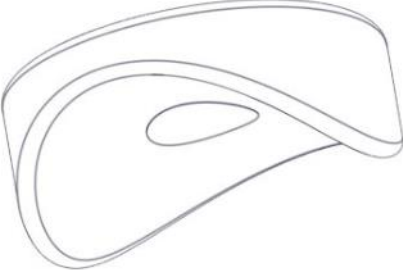
Rør dbl for ringer Sort 07-500-295K	Navn	Artnr/dimensjon	Ant	Lev
	Plast rørfeste	05-301-036	10	
	Plast rørfeste endelokk	05-301-036	10	
	Låsemutter M10	04-040-010	10	
	Avstandsskive til Ø38	04-210-010	10	