

N**Monteringsanvisning****EN****Assembly Instructions****S****Monteringsanvisning**

Produkt nr. / Product no. / Produkt nr.

07-500-372K**Sort**

Ord. nr. _____

Dato. _____

Sign. _____

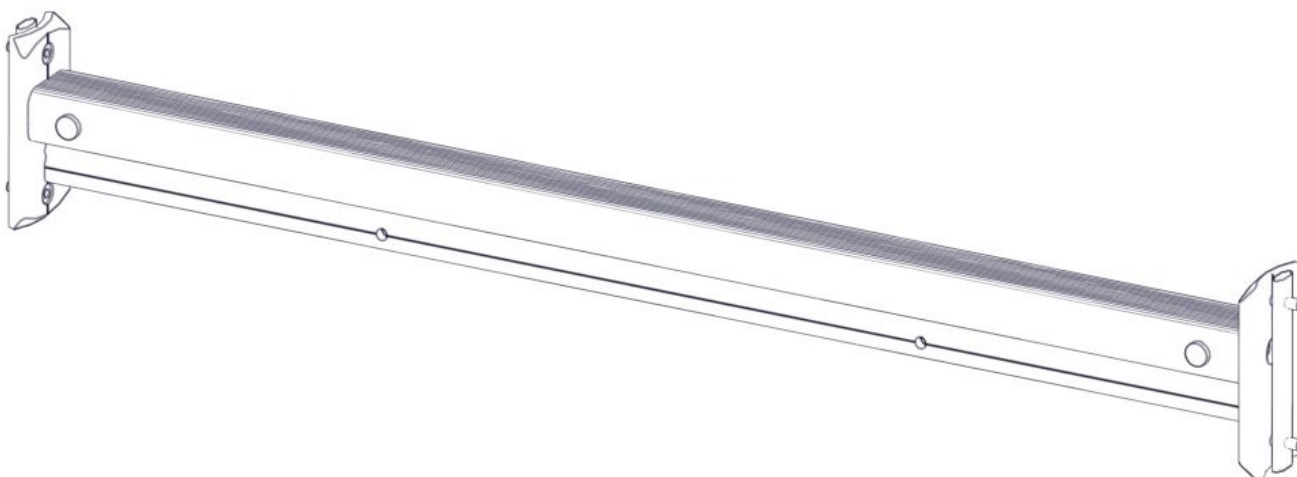
**søve**



Søve AS
Grønnvoldveien 290
3830 Ulefoss - Norway
Tlf: +47 35 94 65 65
www.sove.no

**søve**

Søve AB
EA Rosengrensgatan 32
421 31 Västra Frölunda
Phone: +46 (0)31 773 97 00
www.sove.se

Boltepakker for // Boltpackage for // Bultpaket för

Sign. _____.

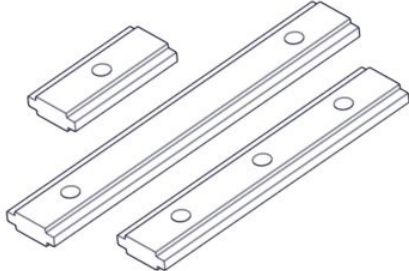
Drager med 0gr beslag 2 hull Sort komplett 07-500-372K	Navn	Artnr/dimensjon	Ant	Lev
	Drager med 0gr beslag cc1143 2 hull cc450 Sort	07-500-372	1	
	Torx M8x25	04-000-025	4	
	Brikke 150 2xM8	04-060-151	2	

Montering av lekeapparatet / Assembly instructions / Montering av lekredskapet

Se på hovedmontering for posisjon
 Look at main assembly for position
 Titta på hovudmontering för position

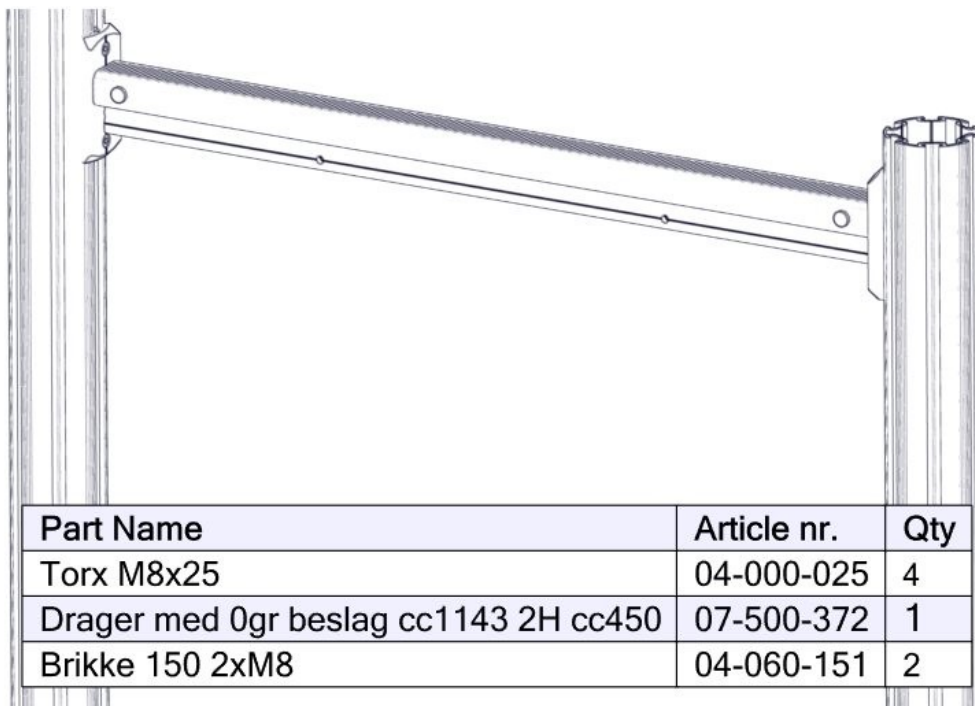

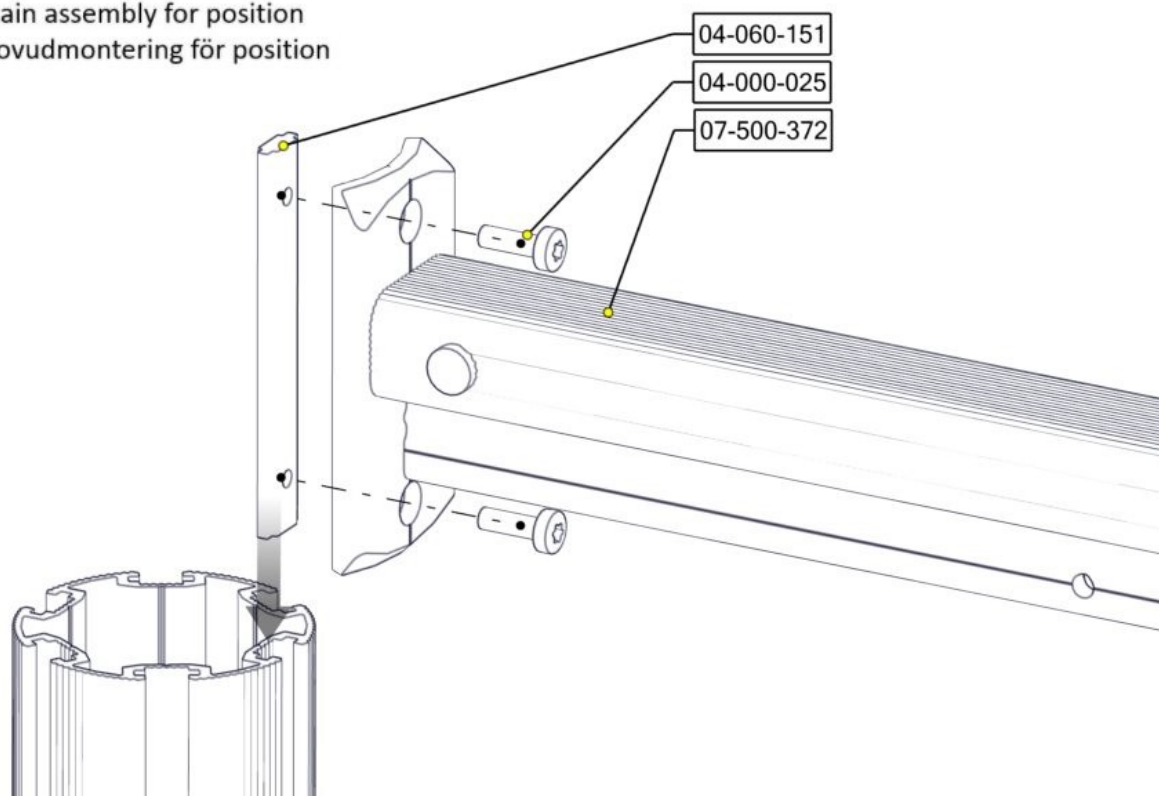

Se på hovedmontering for posisjon
 Look at main assembly for position
 Titta på hovudmontering för position



Boltepakker for // Boltpackage for // Bultpaket för

Sign. _____.

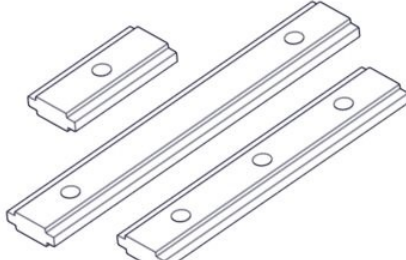
Drager med 0gr beslag 2 hull Sort komplett 07-500-372K	Navn	Artnr/dimensjon	Ant	Lev
	Drager med 0gr beslag cc1143 2 hull cc450 Sort	07-500-372	1	
	Torx M8x25	04-000-025	4	
	Brikke 150 2xM8	04-060-151	2	