

N

Monteringsanvisning

EN

Assembly Instructions

S

Monteringsanvisning

Produkt nr. / Product no. / Produkt nr.

07-500-392K**Grå/Gul**

Ord. nr. _____

Dato. _____

Sign. _____

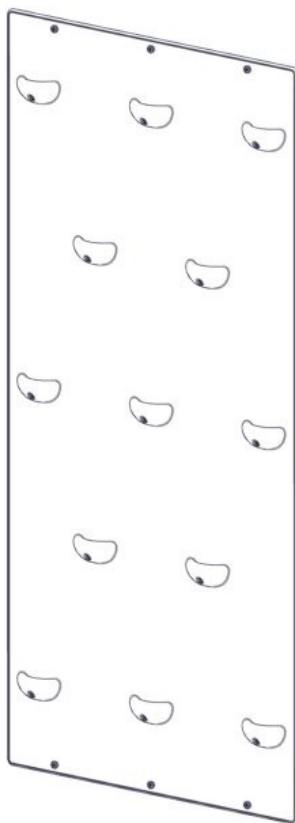
**søve**



Søve AS
Grønnvoldveien 290
3830 Ulefoss - Norway
Tlf: +47 35 94 65 65
www.sove.no

**søve**

Søve AB
EA Rosengrensgatan 32
421 31 Västra Frölunda
Phone: +46 (0)31 773 97 00
www.sove.se

Boltepakker for // Boltpackage for // Bultpaket för

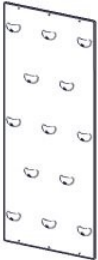
Sign. _____.

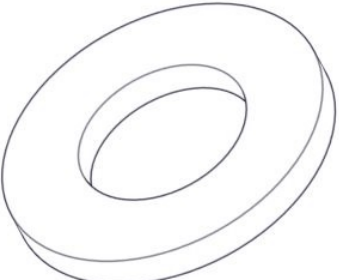
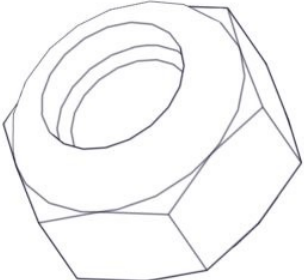
Klatreplate Grå/Gul 07-500-392K	Navn	Artnr/dimensjon	Ant	Lev
	Klatreplate Grå/Gul	07-500-392	1	
	Torx M8x30	04-000-030	6	
	Skive M8	04-050-008	6	
	Låsemutter M8	04-040-008	6	

Montering av lekeapparatet / Assembly instructions / Montering av lekredskapet

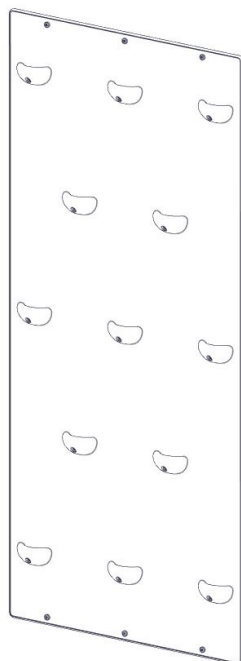

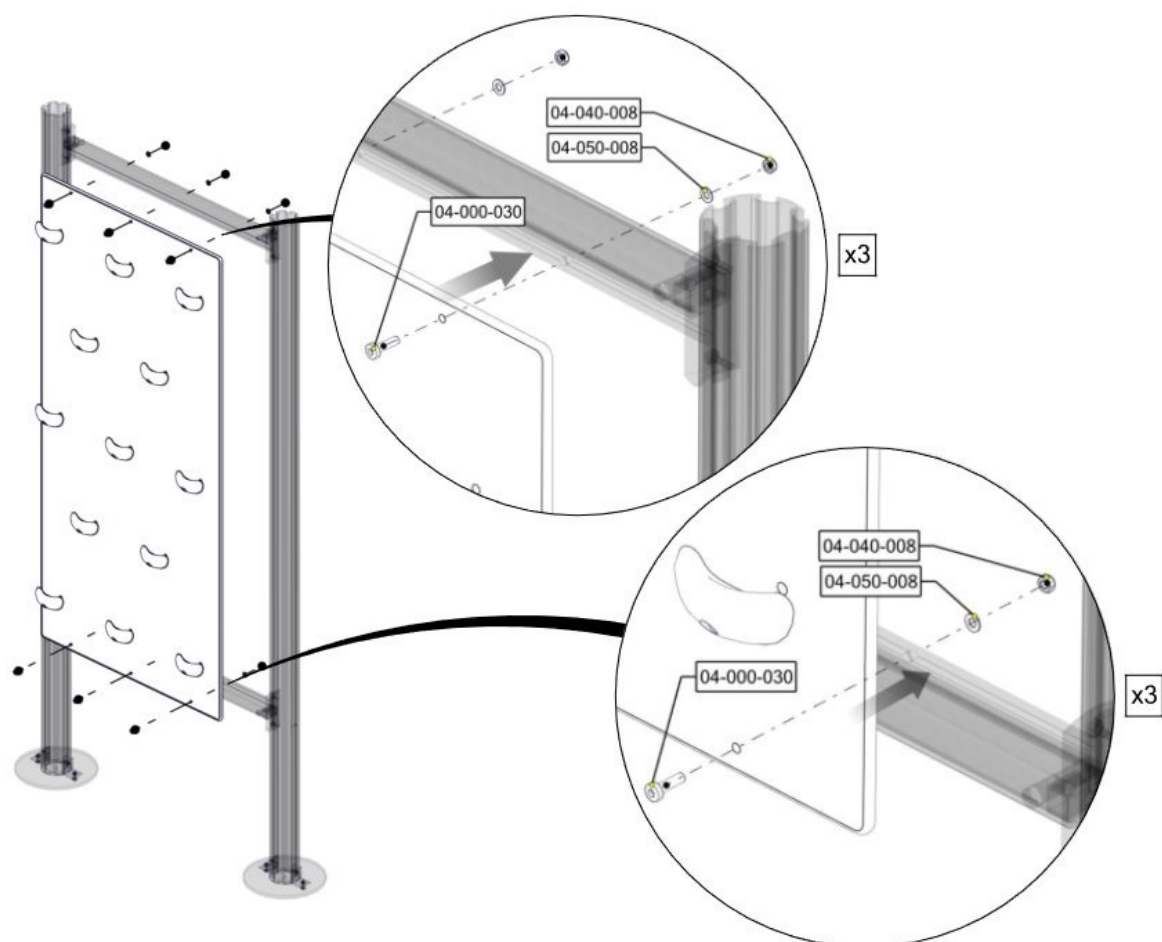

Part Name	Article nr.	Qty
Torx M8x30	04-000-030	6
Skive M8	04-050-008	6
Låsemutter M8	04-040-008	6

Part Name	Article nr.	Qty
Klatreplate Grå/Gul	07-500-392	1

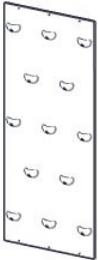

Boltepakker for // Boltpackage for // Bultpaket för

Sign. _____.

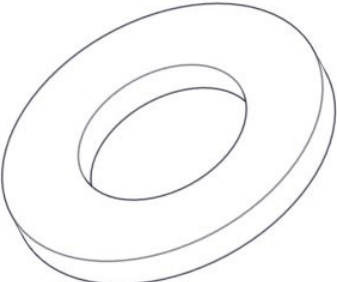
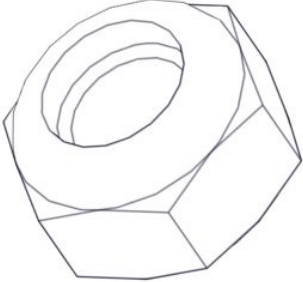
Klatreplate Grå/Gul 07-500-392K	Navn	Artnr/dimensjon	Ant	Lev
	Klatreplate Grå/Gul	07-500-392	1	
	Torx M8x30	04-000-030	6	
	Skive M8	04-050-008	6	
	Låsemutter M8	04-040-008	6	