

N

Monteringsanvisning

EN

Assembly Instructions

S

Monteringsanvisning

Produkt nr. / Product no. / Produkt nr.

07-510-185K**Sort**

Ord. nr. _____

Dato. _____

Sign. _____

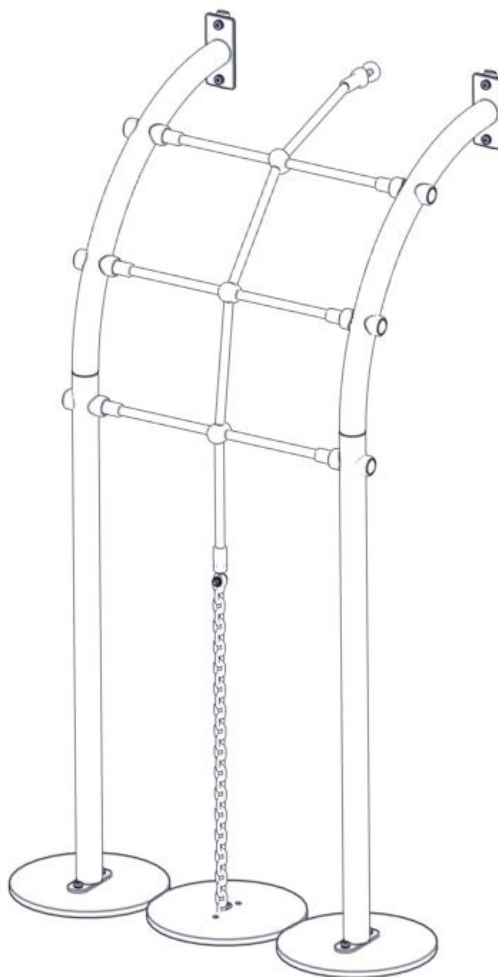
**søve**





Søve AS
Grønnvoldveien 290
3830 Ulefoss - Norway
Tlf: +47 35 94 65 65
www.sove.no

**søve**

Søve AB
EA Rosengrensgatan 32
421 31 Västra Frölunda
Phone: +46 (0)31 773 97 00
www.sove.se

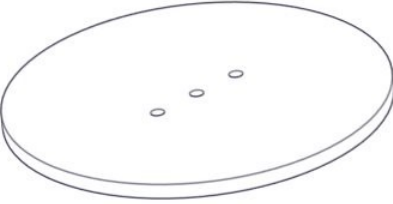
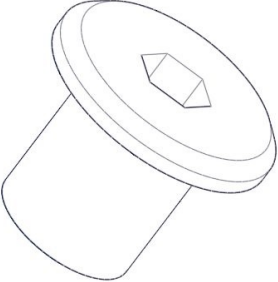

Boltepakker for / Boltpackage for / Bultpaket för

Sign. _____

| Nett oppgang H=95 Sort 07-510-185K | Navn | Artnr/ dimensjon | Ant | Lev |
|---|-------------------------------------|--------------------------|--------|-----|
|  | Rør til nettbro oppgang Sort | 07-510-185 | 2 | |
|  | Nett oppgang H=95 bare nett Sort | 07-510-184 | 1 | |
|  | Fundamentplate | 00-003-103 | 3 | |
|  | Møbelknapp M8x25 | 04-030-025 | 1 | |
|  | Torx M8x35 Torx M8x25 | 04-000-035 04-000-05 | 5 4 | |
|  | Låsemutter M8 Låsemutter M10 | 04-040-008 04-040-010 | 5 6 | |

Boltepakker for / Boltpackage for / Bultpaket för

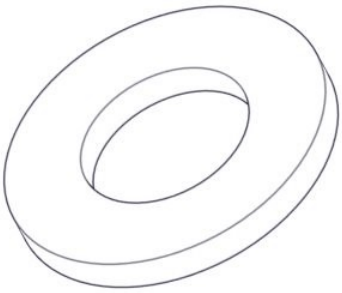
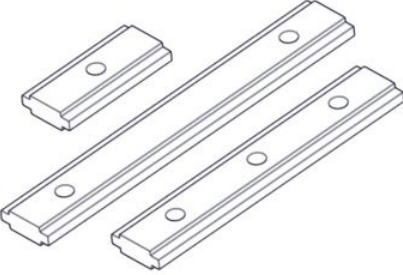
Sign. _____

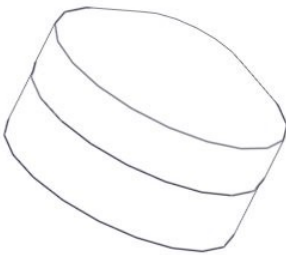
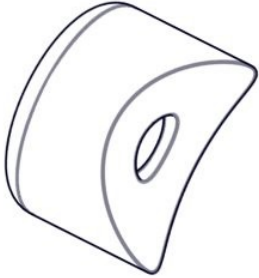
| Nett oppgang H=95 Grå/Sort 07-510-185K | Navn | Artnr/ dimensjon | Ant | Lev |
|---|--|--|--------------|-----|
|  | Skive M8 Skive M8 Stor Skive M10 Polyfix | 04-050-008 04-055-008 04-055-036 | 8 5 12 | |
|  | Brikke 150 2xM8 | 04-060-151 | 2 | |
|  | Avstandskive Radie 38 Sort | 04-210-010 | 2 | |
|  | Plast rørfeste, hode Sort | 05-301-036 | 6 | |
|  | Plast rørfeste, kropp Sort | 05-301-036 | 12 | |
| | | | | |

Montering av lekeapparatet / Assembly instructions / Montering av lekredskapet

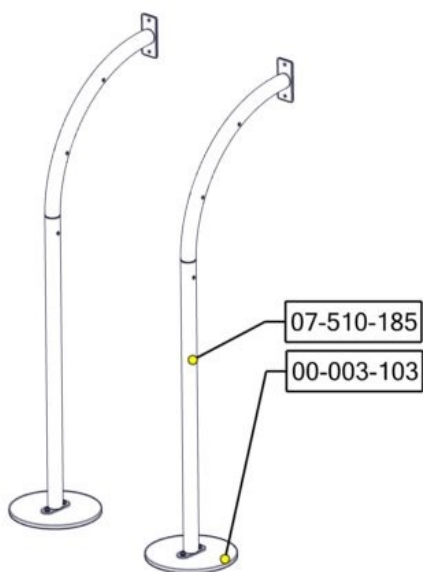

| Part Name | Article nr. | Qty |
|-------------------------|-------------|-----|
| Torx M8x35 | 04-000-035 | 4 |
| Skive M8 stor | 04-055-008 | 4 |
| Skive M8 | 04-050-008 | 4 |
| Rør til nettbro oppgang | 07-510-185 | 2 |

| Part Name | Article nr. | Qty |
|-----------------|-------------|-----|
| Låsemutter M8 | 04-040-008 | 4 |
| Fundament plate | 00-003-103 | 2 |

2x

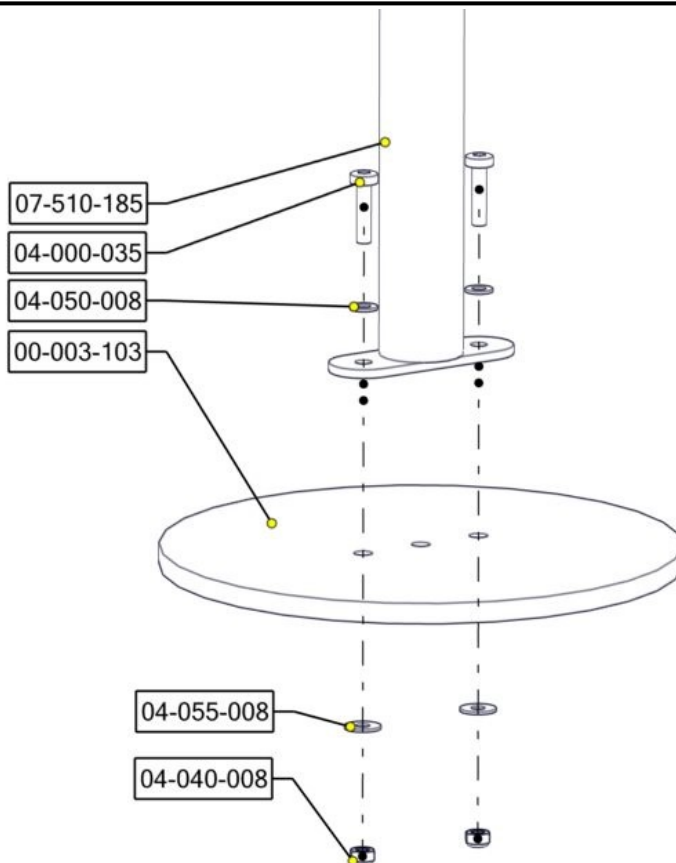

Montering av lekeapparatet / Assembly instructions / Montering av lekredskapet

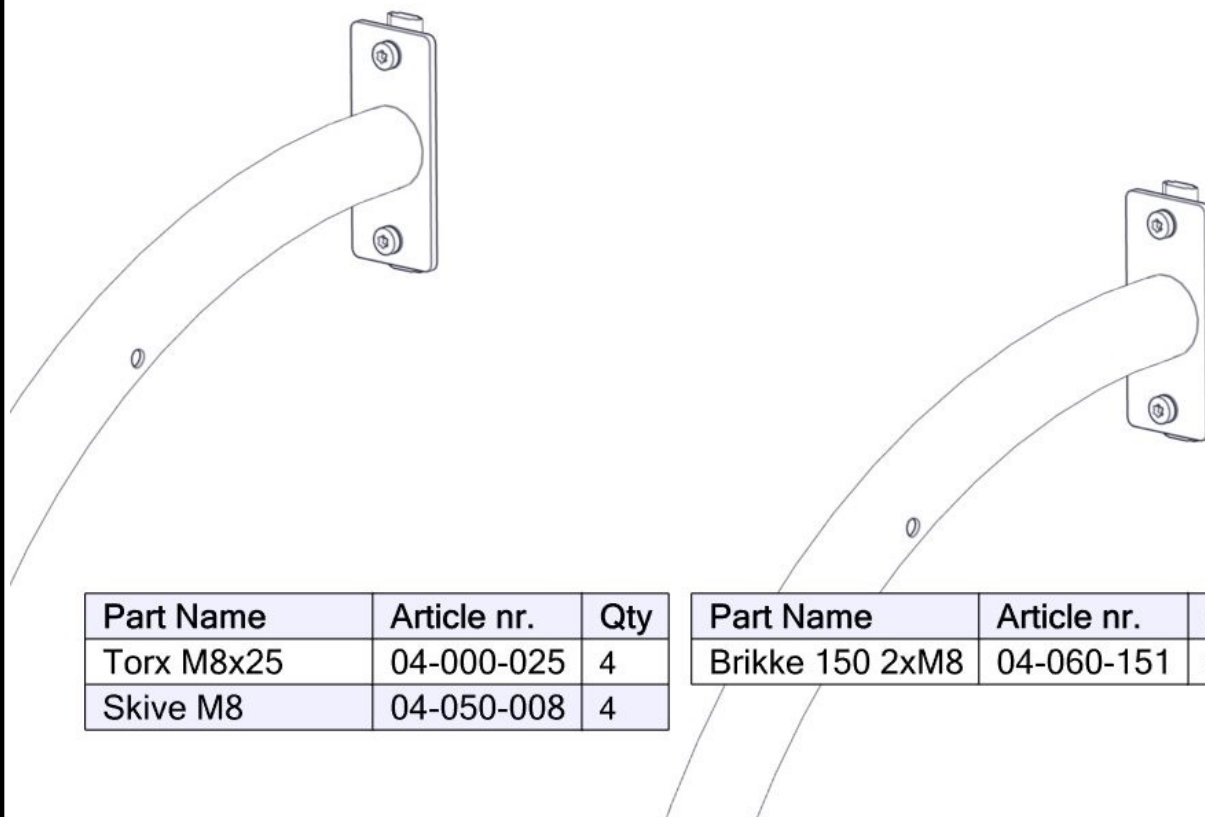

| Part Name | Article nr. | Qty |
|------------|-------------|-----|
| Torx M8x25 | 04-000-025 | 4 |
| Skive M8 | 04-050-008 | 4 |

| Part Name | Article nr. | Qty |
|-----------------|-------------|-----|
| Brikke 150 2xM8 | 04-060-151 | 2 |

Se på hovedmontering for posisjon
 Look at main assembly for position
 Titta på hovudmontering för position

2x

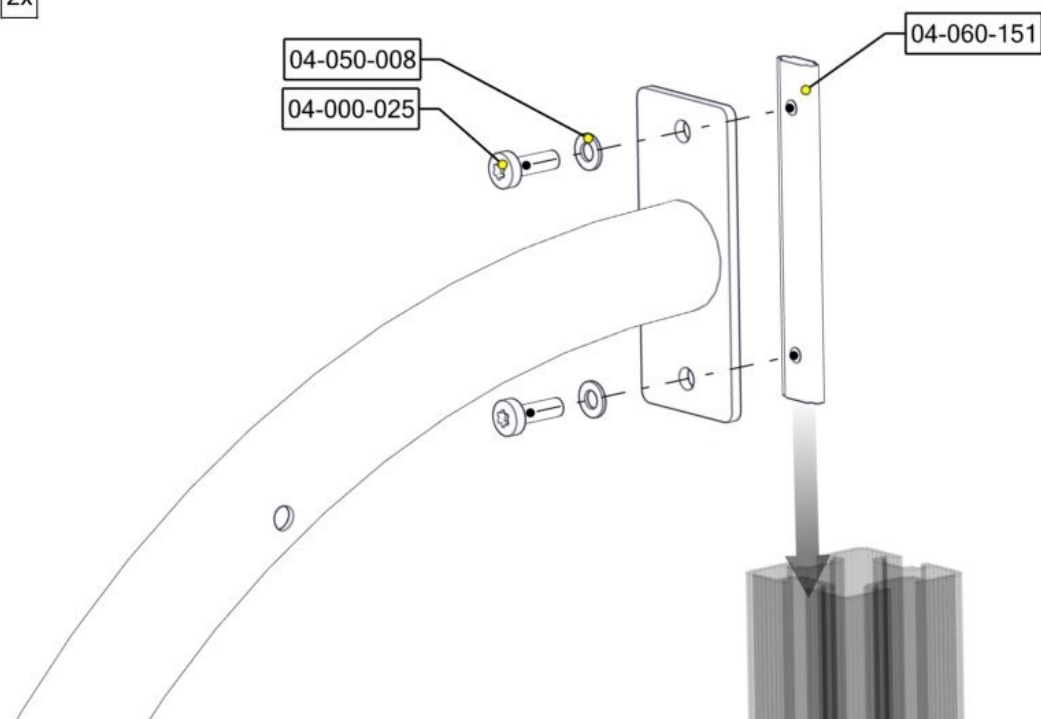

Montering av lekeapparatet / Assembly instructions / Montering av lekredskapet



| Part Name | Article nr. | Qty |
|-----------------------------|-------------|-----|
| Torx M8x35 | 04-000-035 | 1 |
| Skive M8 stor | 04-055-008 | 1 |
| Nett oppgang H=95 bare nett | 07-510-184 | 1 |

| Part Name | Article nr. | Qty |
|-----------------|-------------|-----|
| Låsemutter M8 | 04-040-008 | 1 |
| Fundament plate | 00-003-103 | 1 |

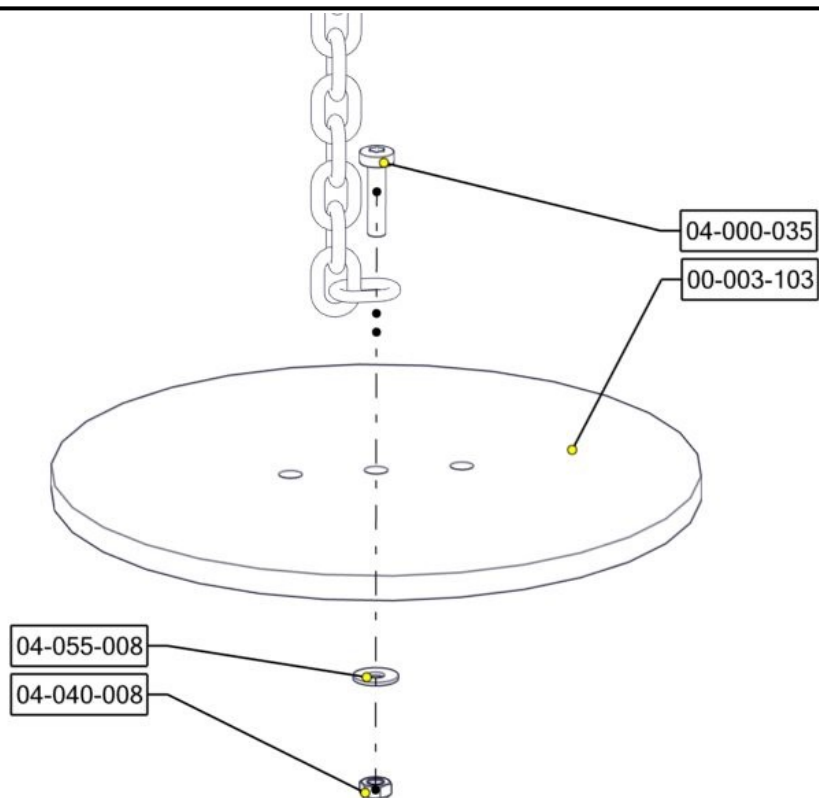

Montering av lekeapparatet / Assembly instructions / Montering av lekredskapet





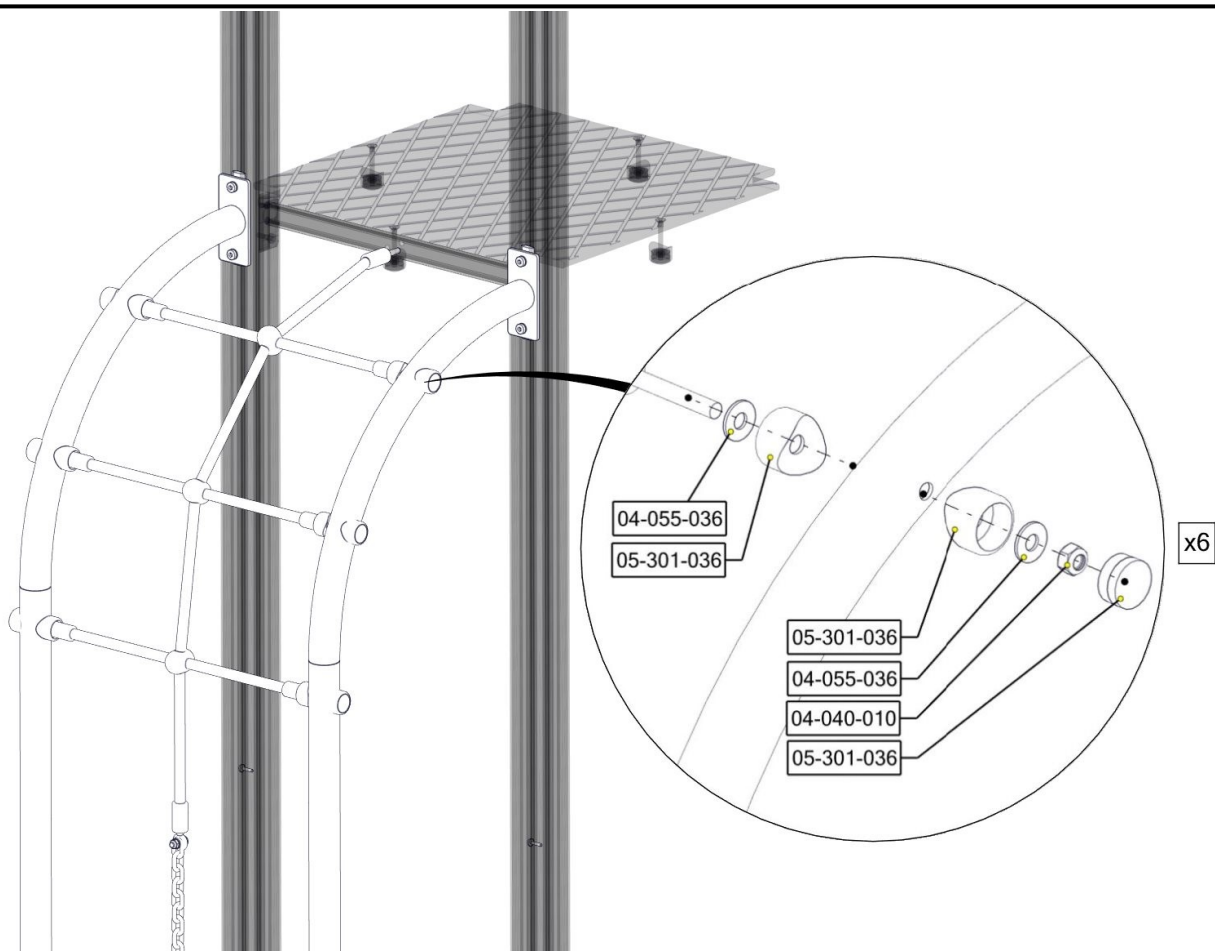

| Part Name | Article nr. | Qty |
|-----------------------|-------------|-----|
| Skive M10 polyfix | 04-055-036 | 12 |
| Plast rørfeste, kropp | 05-301-036 | 12 |
| Plast rørfeste, hode | 05-301-036 | 6 |

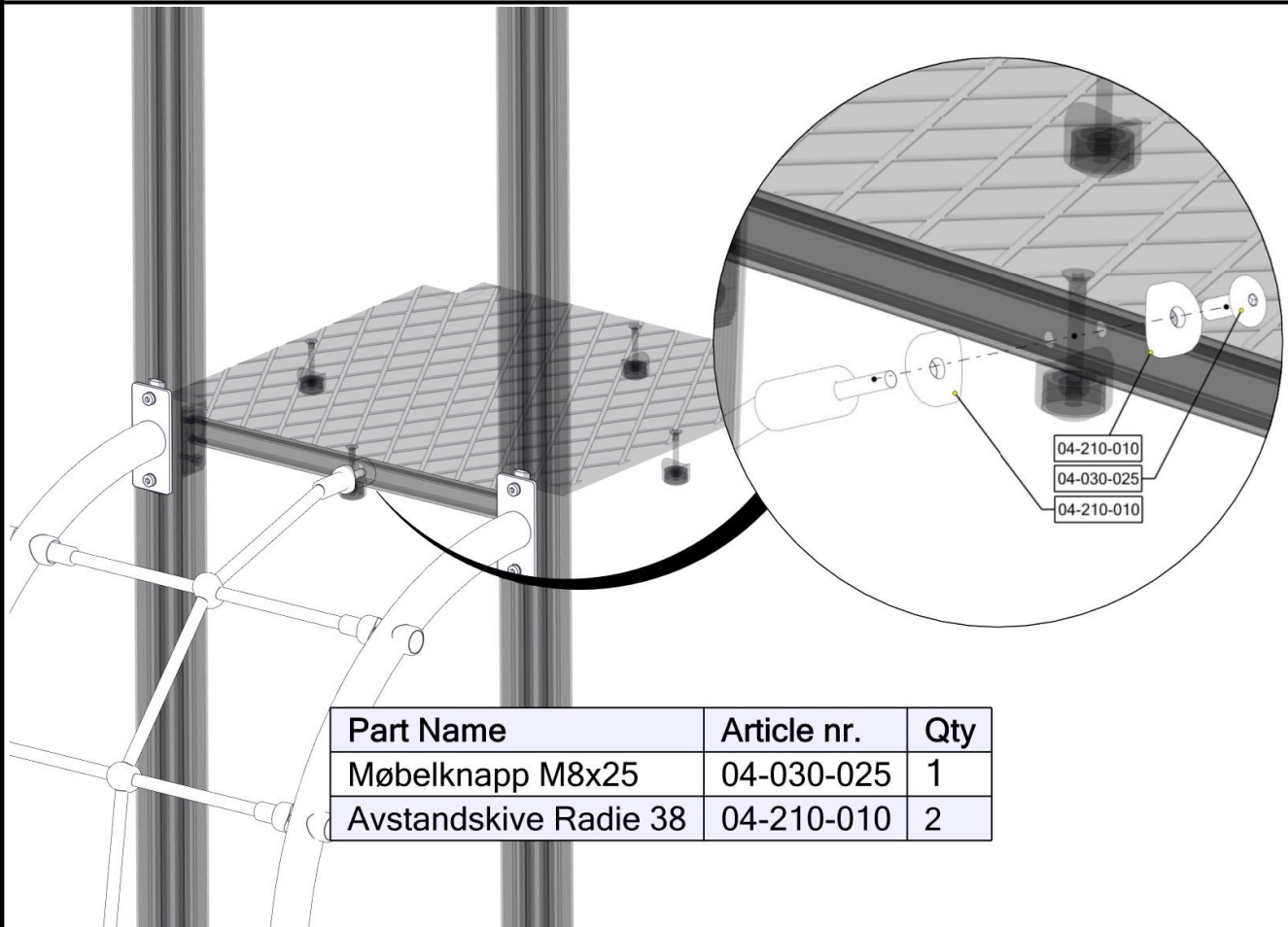
| Part Name | Article nr. | Qty |
|----------------|-------------|-----|
| Låsemutter M10 | 04-040-010 | 6 |

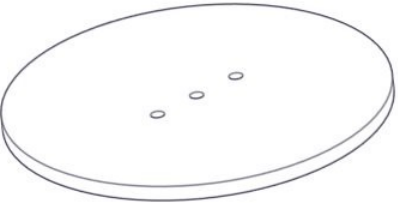
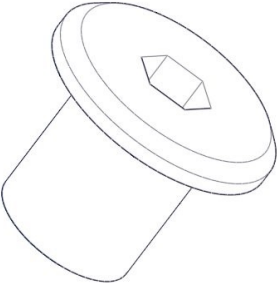

Montering av lekeapparatet / Assembly instructions / Montering av lekredskapet

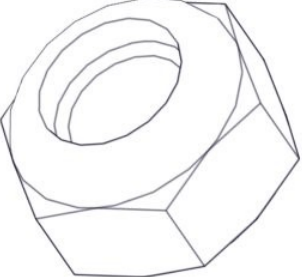
| Boltepakker for / Boltpackage for / Bultpaket för | | Sign. _____ | | |
|---|-------------------------------------|-----------------------------|------------|------------|
| Nett oppgang H=95 Sort 07-510-185K | Navn | Artnr/ dimensjon | Ant | Lev |
|  | Rør til nettbro oppgang Sort | 07-510-185 | 2 | |
|  | Nett oppgang H=95 bare nett Sort | 07-510-184 | 1 | |
|  | Fundamentplate | 00-003-103 | 3 | |
|  | Møbelknapp M8x25 | 04-030-025 | 1 | |
|  | Torx M8x35 | 04-000-035 | 5 | |
| | Torx M8x25 | 04-000-05 | 4 | |
|  | Låsemutter M8 | 04-040-008 | 5 | |
| | Låsemutter M10 | 04-040-010 | 6 | |

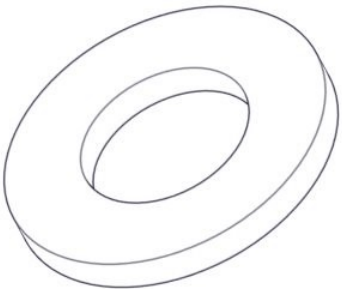
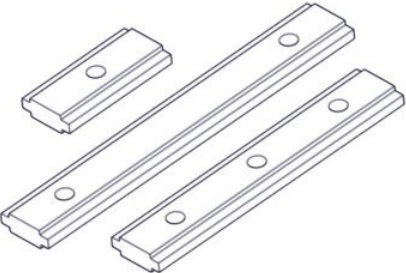
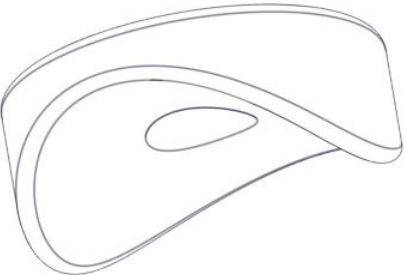
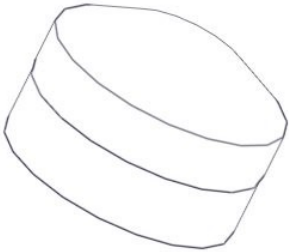
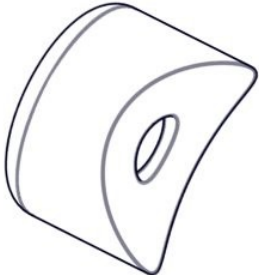
| Boltepakker for / Boltpackage for / Bultpaket för | | Sign. _____. | | |
|---|-------------------------------|-----------------------------|------------|------------|
| Nett oppgang H=95 Grå/Sort 07-510-185K | Navn | Artnr/ dimensjon | Ant | Lev |
|  | Skive M8 | 04-050-008 | 8 | |
| | Skive M8 Stor | 04-055-008 | 5 | |
| | Skive M10 Polyfix | 04-055-036 | 12 | |
|  | Brikke 150 2xM8 | 04-060-151 | 2 | |
|  | Avstandskive Radie 38 Sort | 04-210-010 | 2 | |
|  | Plast rørfeste, hode Sort | 05-301-036 | 6 | |
|  | Plast rørfeste, kropp Sort | 05-301-036 | 12 | |
| | | | | |