

N**Monteringsanvisning****EN****Assembly Instructions****S****Monteringsanvisning**

Produkt nr. / Product no. / Produkt nr.

07-510-187K**Sort**

Ord. nr. _____

Dato. _____

Sign. _____

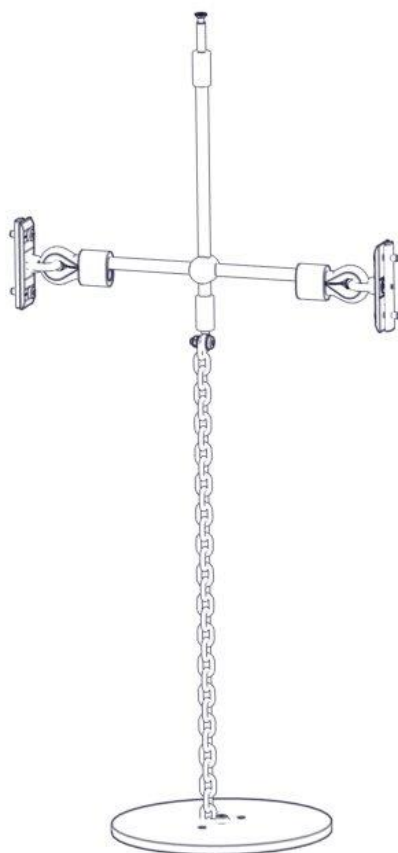
**sove**



Søve AS
Grønnvoldveien 290
3830 Ulefoss - Norway
Tlf: +47 35 94 65 65
www.sove.no

**sove**

Søve AB
EA Rosengrensgatan 32
421 31 Västra Frölunda
Phone: +46 (0)31 773 97 00
www.sove.se

Boltepakker for / Boltpackage for / Bultpaket för

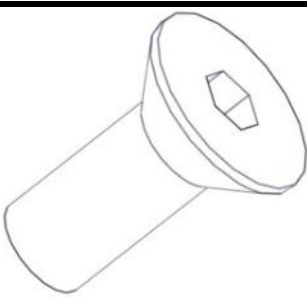
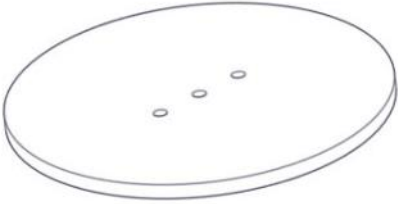
Sign. _____

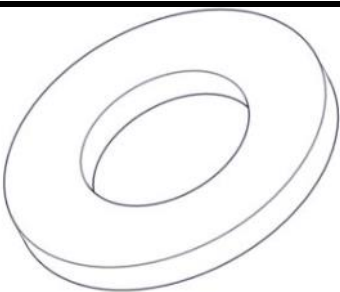
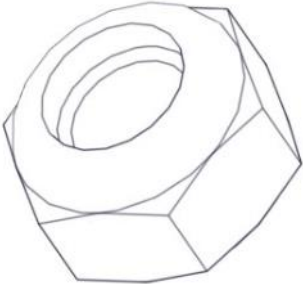
Nett under gulv H=550 07-510-187K	Navn	Artnr/ dimensjon	Ant	Lev
	Mini vertikal nett under gulv H=550 Sort	07-510-187	1	
	Unbrako M8x25 forsenket	04-034-025	1	
	Fundamentplate	00-003-103	1	
	Torx M8x25 Torx M8x35	04-000-025 04-000-035	4 1	
	Skive M8 stor	04-055-008	4	
	Låsemutter M8	04-040-008	1	

Boltepakker for / Boltpackage for / Bultpaket för

Sign. _____.

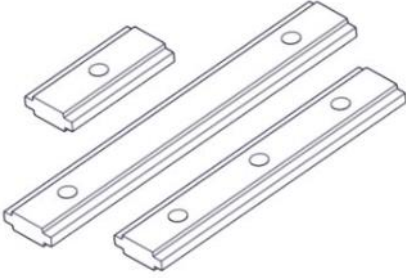
Nett under gulv H=550 07-510-187K	Navn	Artnr/ dimensjon	Ant	Lev
	Brikke 120 x 3M8	04-060-120	2	

Montering av lekeapparatet / Assembly instructions / Montering av lekredskapet

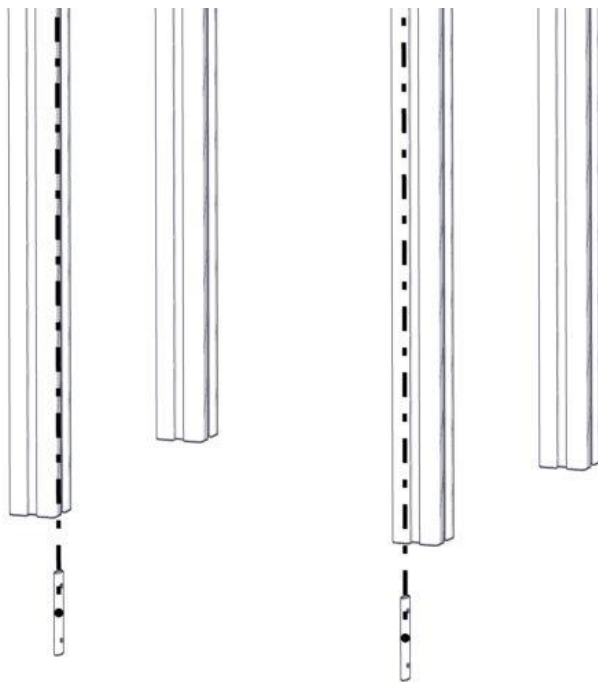

nr	PartName	Artnr	Antall
1	Brikke 120 3xM8	04-060-120	2

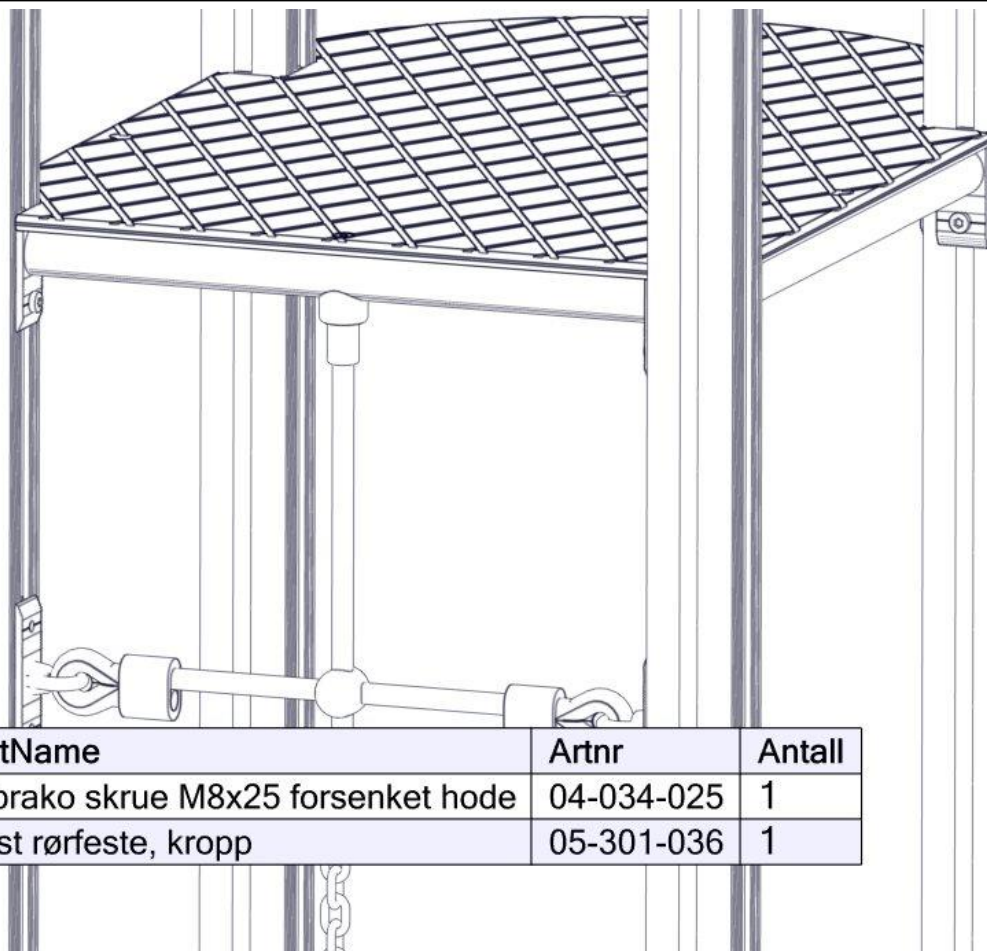

nr	PartName	Artnr	Antall
1	Unbrako skrue M8x25 forsenket hode	04-034-025	1
2	Plast rørfeste, kropp	05-301-036	1

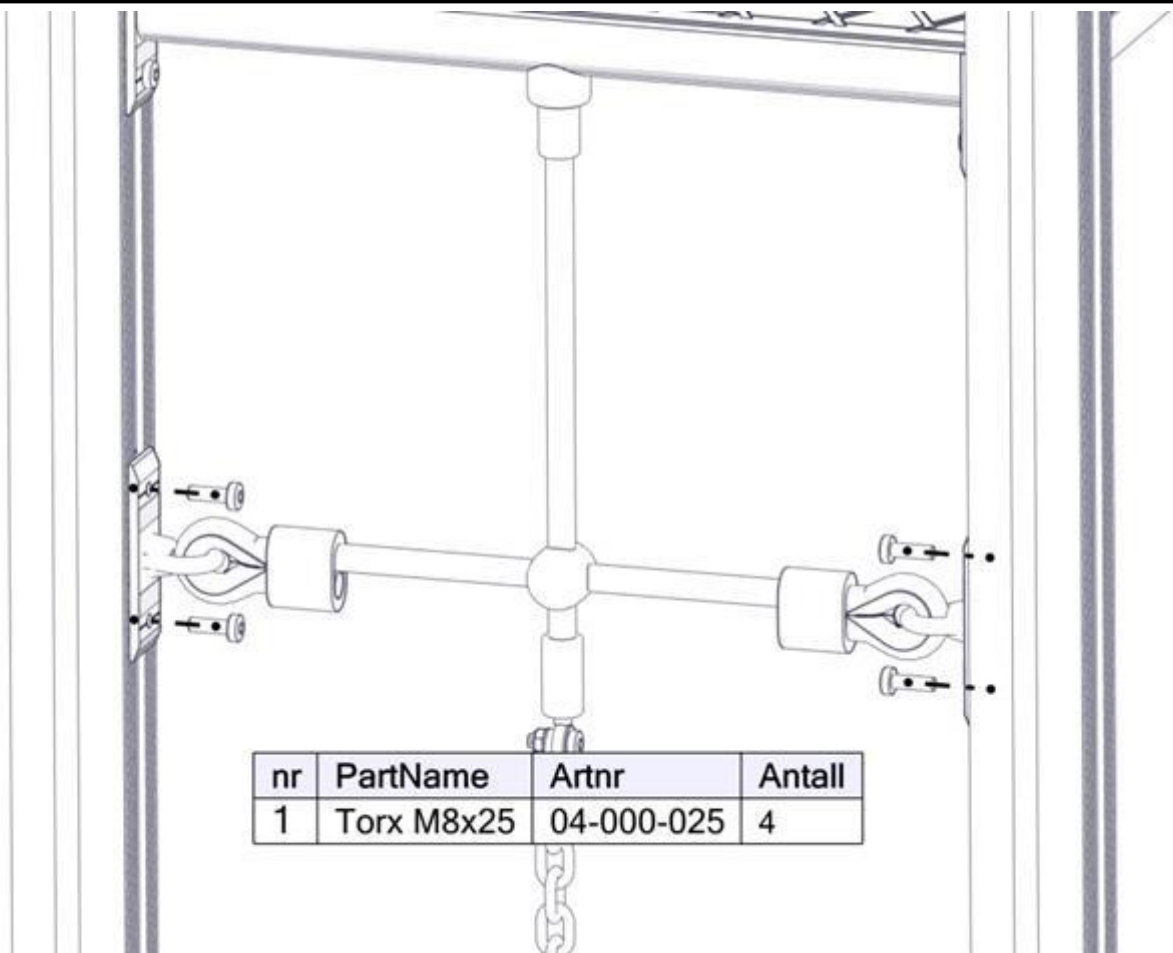
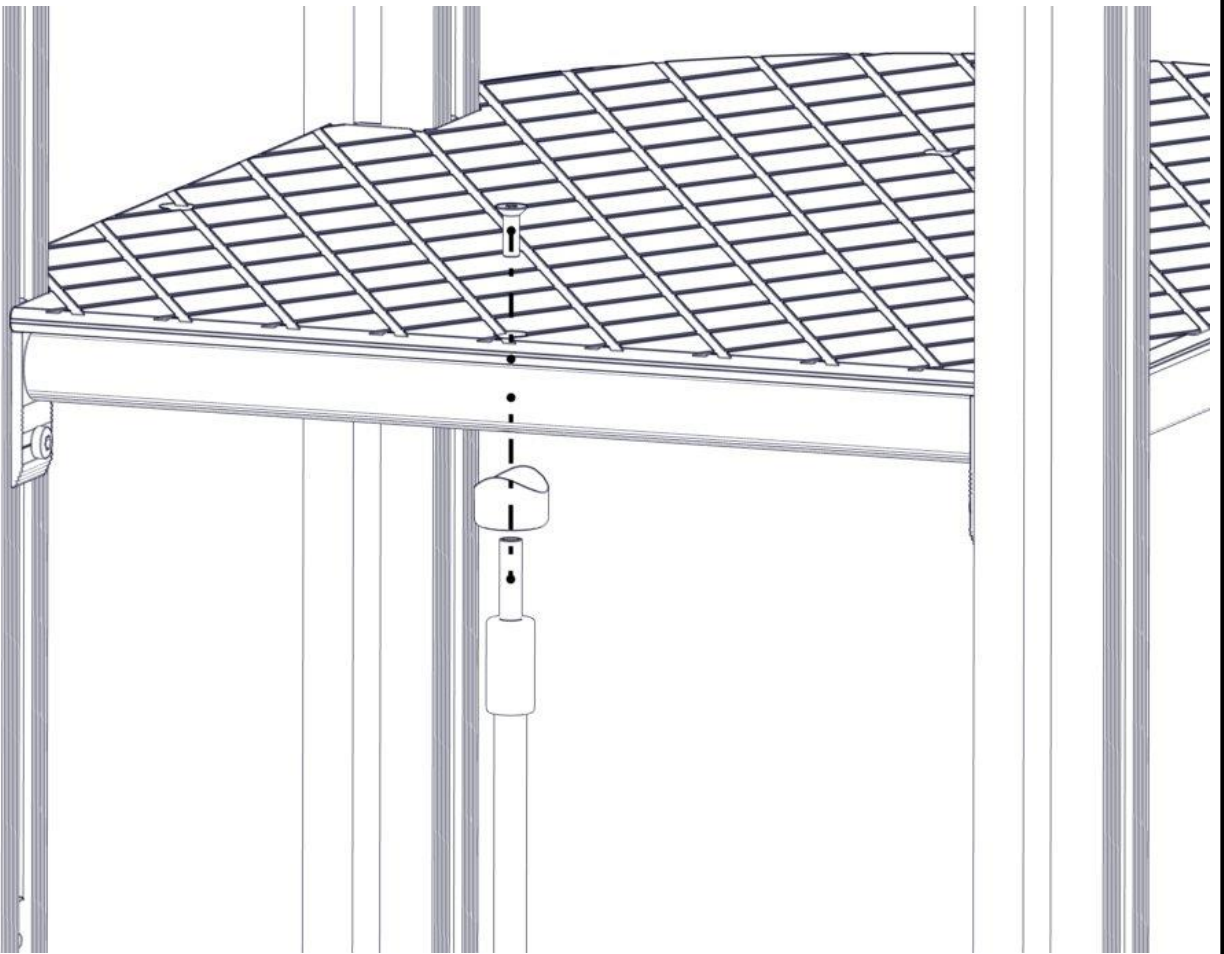
Montering av lekeapparatet / Assembly instructions / Montering av lekredskapet

nr	PartName	Artnr	Antall
1	Torx M8x25	04-000-025	4

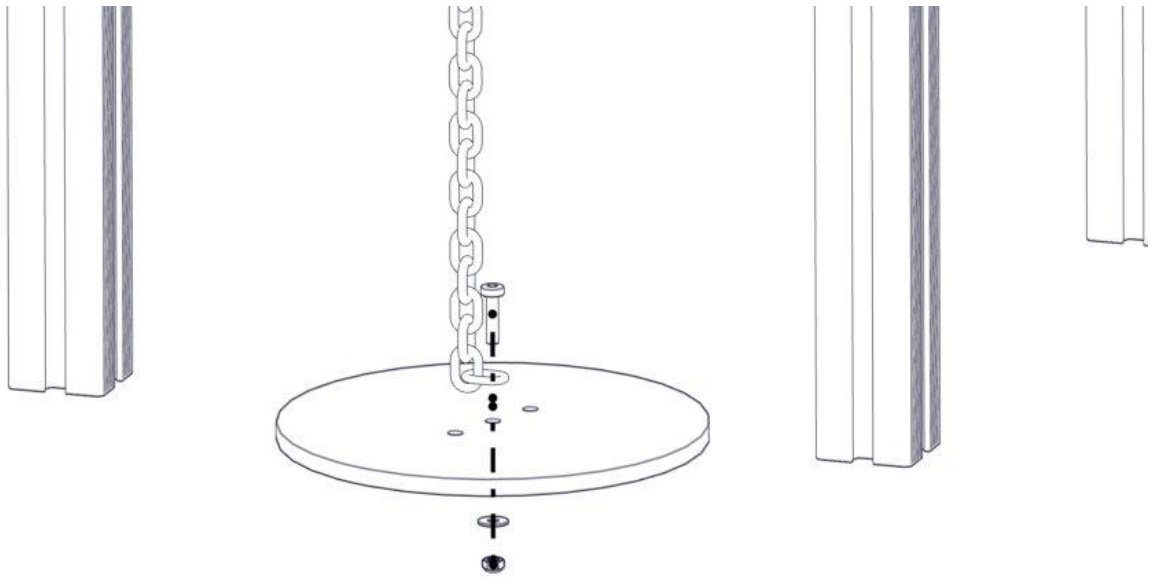



Montering av lekeapparatet / Assembly instructions / Montering av lekredskapet

nr	PartName	Artnr	Antall
1	Fundament plate	00-003-103	1
2	Låsemutter M8	04-040-008	1
3	Skive M8 stor	04-055-008	1

nr	PartName	Artnr	Antall
4	Torx M8x35	04-000-035	1

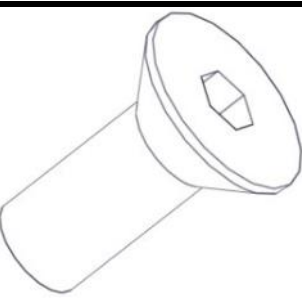
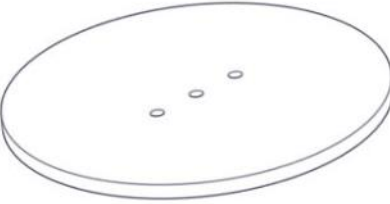
Boltepakker for / Boltpackage for / Bultpaket för

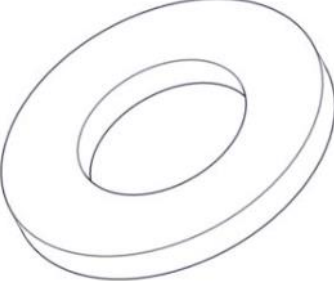
Sign. _____.

Nett under gulv H=550 07-510-187K	Navn	Artnr/ dimensjon	Ant	Lev
	Mini vertikal nett under gulv H=550 Sort	07-510-187	1	
	Unbrako M8x25 forsenket	04-034-025	1	
	Fundamentplate	00-003-103	1	
	Torx M8x25 Torx M8x35	04-000-025 04-000-035	4 1	
	Skive M8 stor	04-055-008	4	
	Låsemutter M8	04-040-008	1	

Boltepakker for / Boltpackage for / Bultpaket för

Sign. _____.

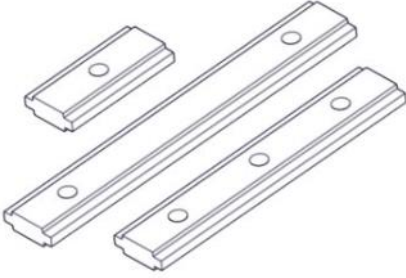
Nett under gulv H=550 07-510-187K	Navn	Artnr/ dimensjon	Ant	Lev
	Brikke 120 x 3M8	04-060-120	2	