

N**Monteringsanvisning****EN****Assembly Instructions****S****Monteringsanvisning**

Produkt nr. / Product no. / Produkt nr.

07-510-305K**Grønn**

Ord. nr. _____

Dato. _____

Sign. _____

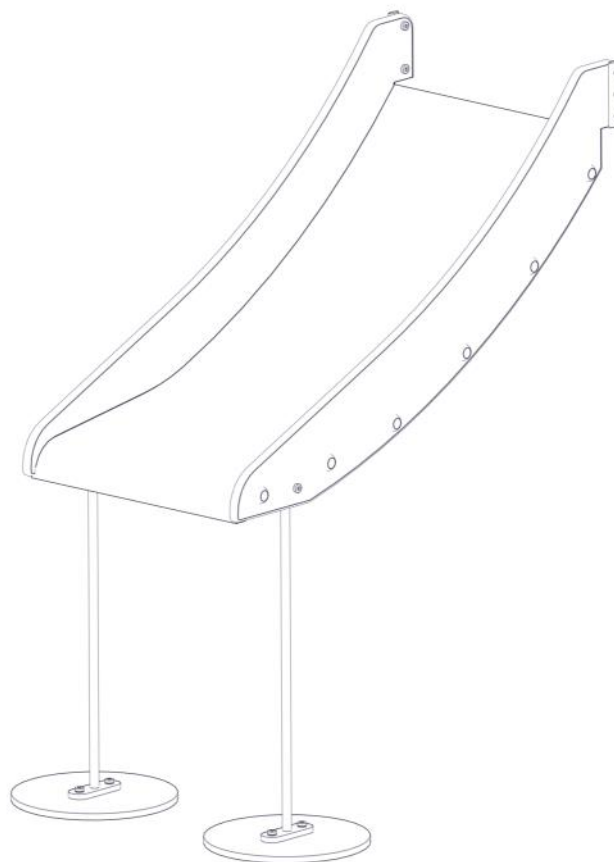
**søve**



Søve AS
Grønnvoldveien 290
3830 Ulefoss - Norway
Tlf: +47 35 94 65 65
www.sove.no



**søve**

Søve AB
EA Rosengrensgatan 32
421 31 Västra Frölunda
Phone: +46 (0)31 773 97 00
www.sove.se

Boltepakker for / Boltpackage for / Bultpaket för

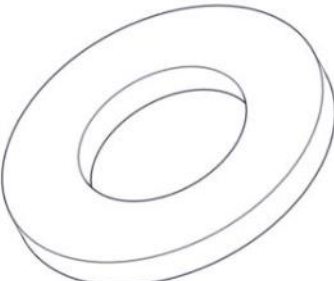
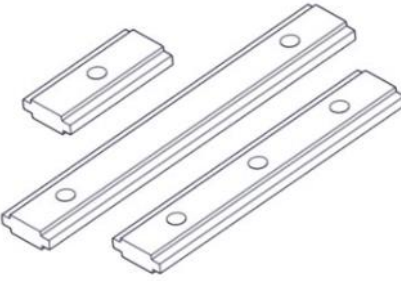
Sign. _____

Rutsjebane H55 07-510-305K grønn	Navn	Artnr/ dimensjon	Ant	Lev
	Rutsjebane Gulvhøyde 0,55m Grønn	07-510-305	1	
	Torx M8x35 Torx M8x50	04-000-035 04-000-050	8 2	
	Låsemutter M8	04-040-008	6	
	Skive M8	04-050-008	10	
	Brikke 120 3xM8	04-060-120	2	

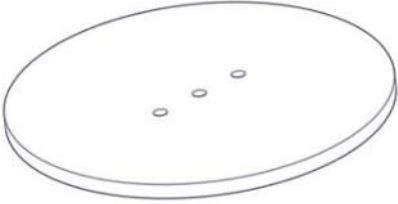
Boltepakker for / Boltpackage for / Bultpaket för		Sign. _____.		
Rutsjebane H55 07-510-305K grønn	Navn	Artnr/dimensjon	Ant	Lev
	Fundament Støp			
	Stålforankring lang L=600mm	00-100-316	2	
	Fundament Nedgraving			
	Stålforankring Lengde = 600mm	00-100-316	2	
	Fundamentplate Rund	00-003-103	2	

Montering av lekeapparatet / Assembly instructions / Montering av lekredskapet

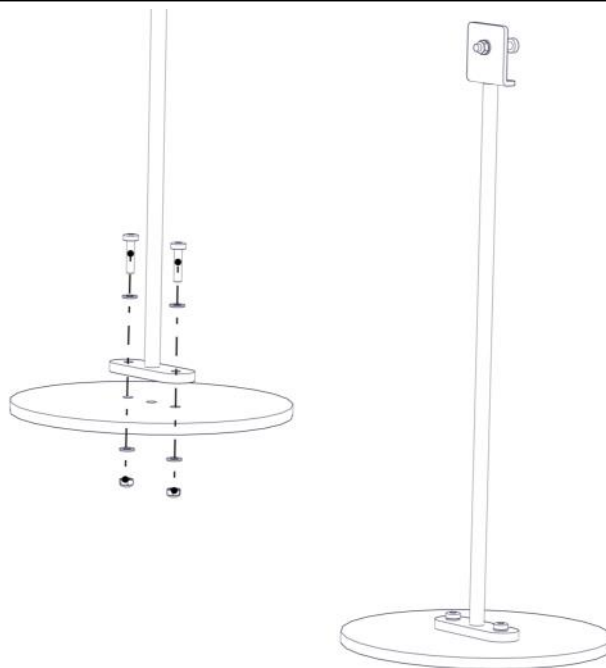

Part Name	Article nr.	Qty
Torx M8x35	04-000-035	4
Stålforankring L=600	00-100-316	2
Skive M8	04-050-008	8

Part Name	Article nr.	Qty
Låsemutter M8	04-040-008	4
Fundament plate	00-003-103	2

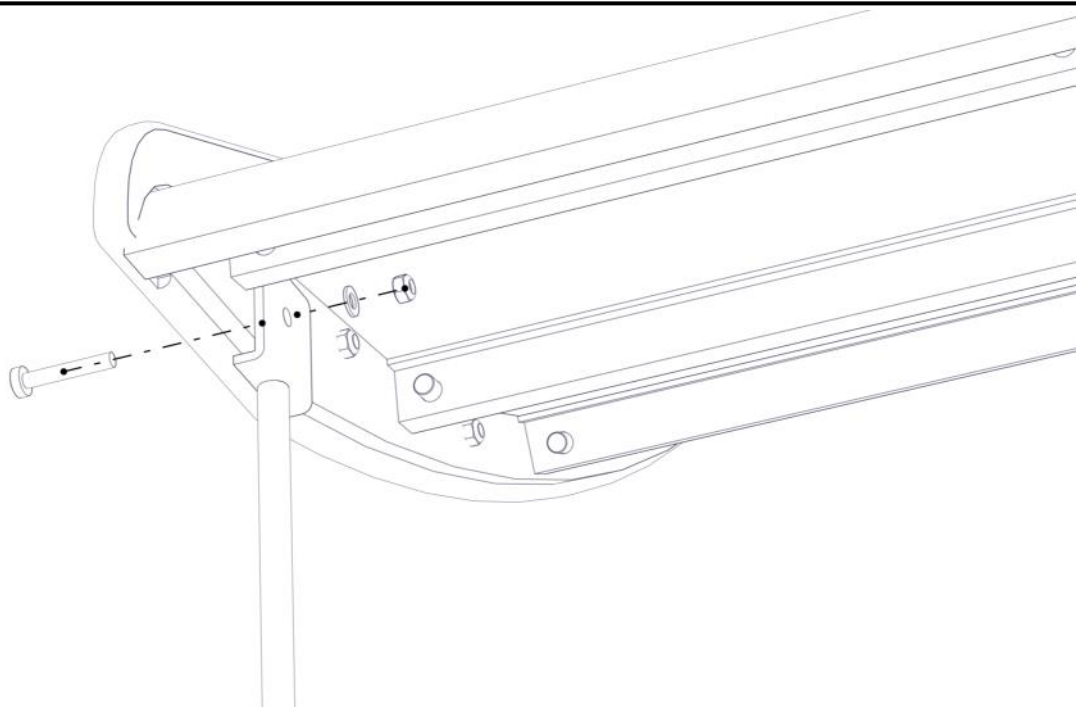

Part Name	Article nr.	Qty
Torx M8x50	04-000-050	2
Skive M8	04-050-008	2
Rutsjebane H55	07-510-305	1

Part Name	Article nr.	Qty
Låsemutter M8	04-040-008	2

Montering av lekeapparatet / Assembly instructions / Montering av lekredskapet

Ikke stram boltene

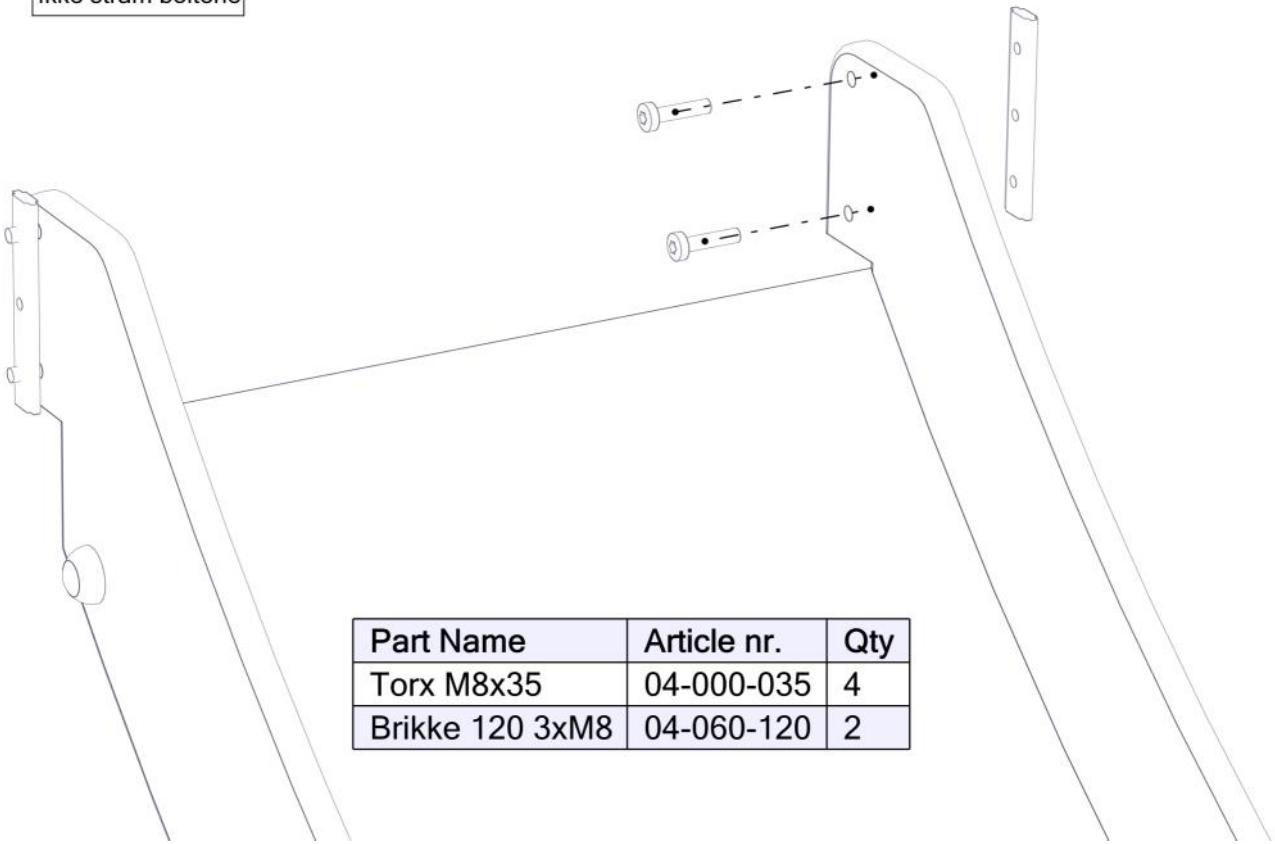

Part Name	Article nr.	Qty
Torx M8x35	04-000-035	4
Brikke 120 3xM8	04-060-120	2

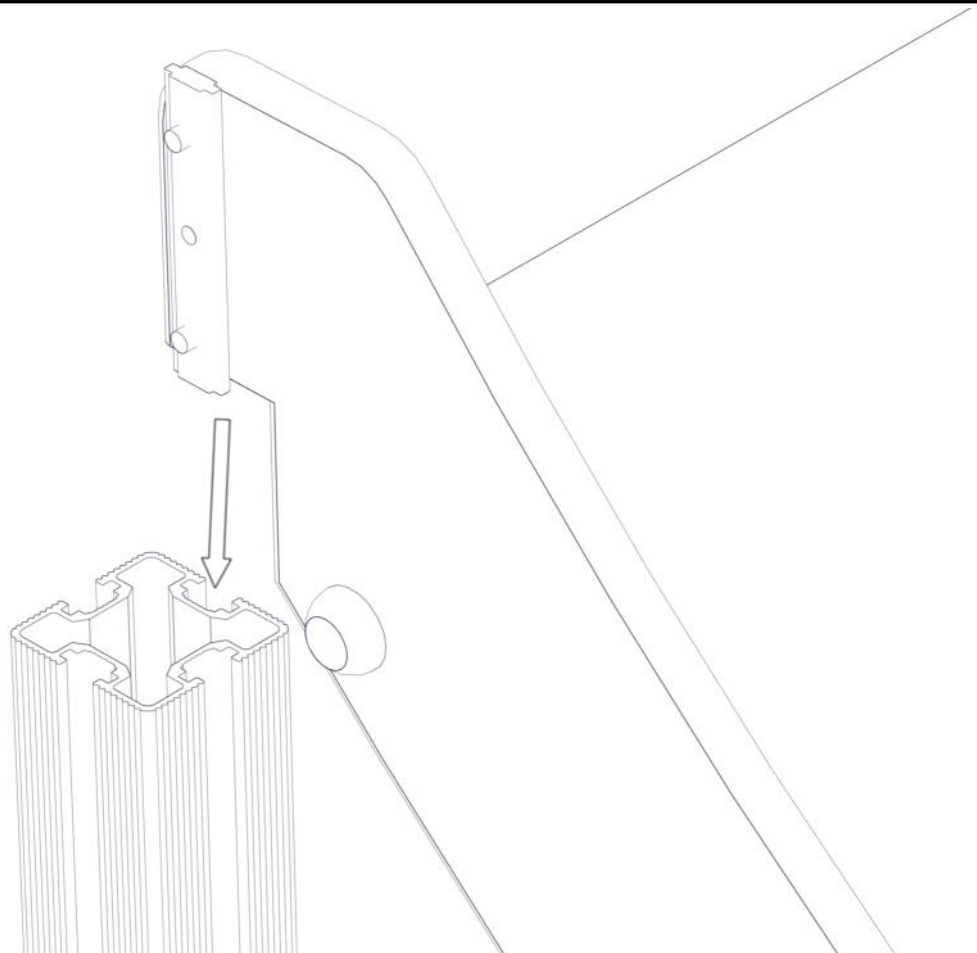



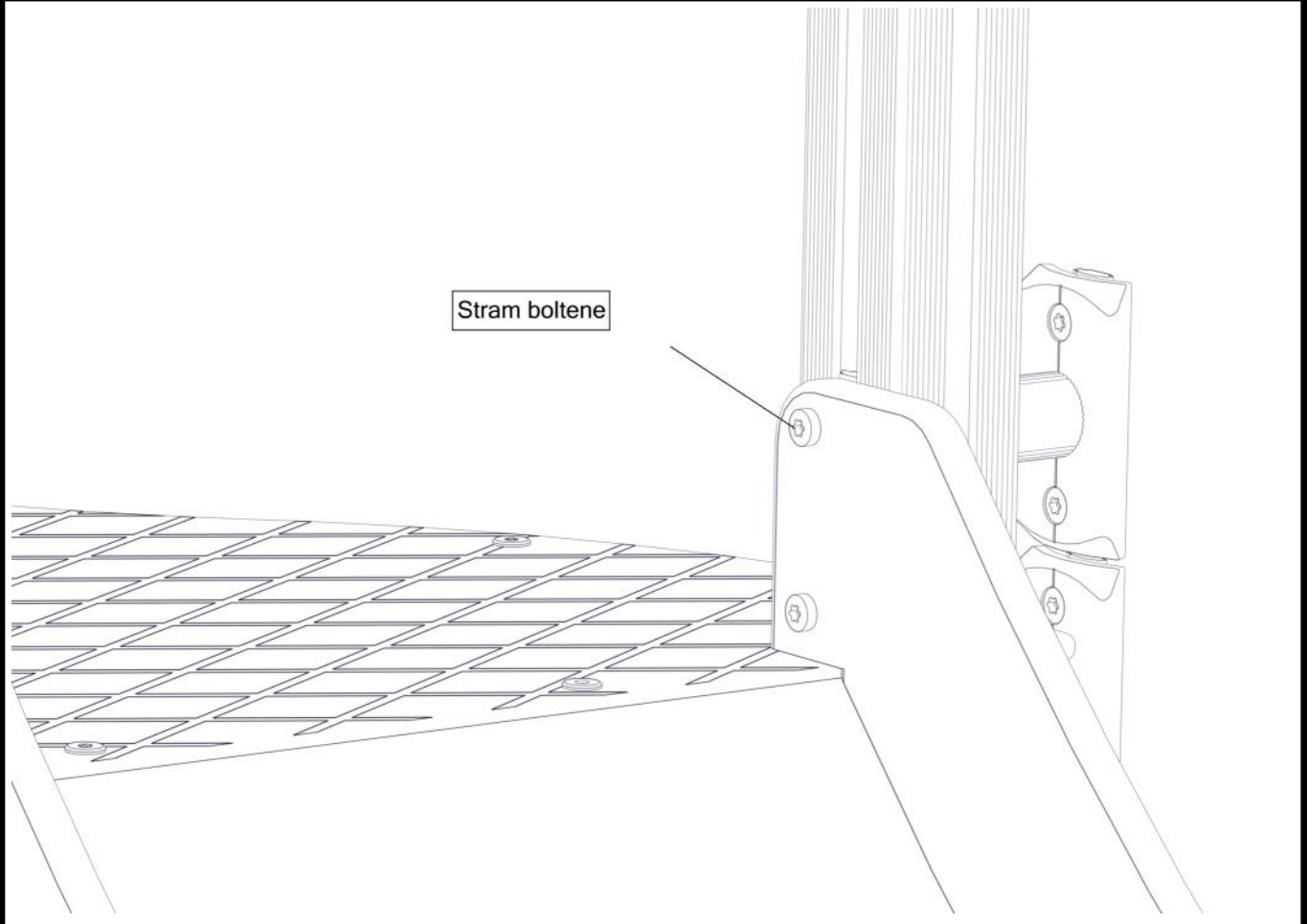

Montering av lekeapparatet / Assembly instructions / Montering av lekredskapet

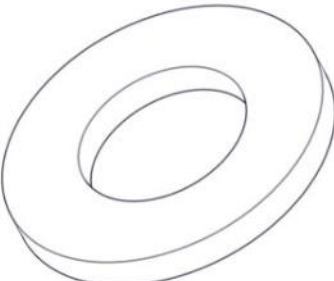
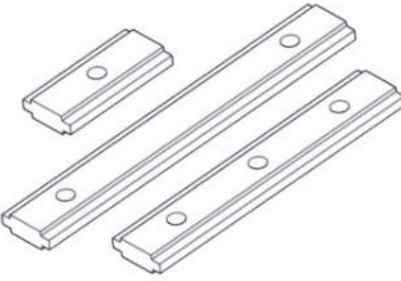

Boltepakker for / Boltpackage for / Bultpaket för

Sign. _____

Rutsjebane H55 07-510-305K grønn	Navn	Artnr/ dimensjon	Ant	Lev
	Rutsjebane Gulvhøyde 0,55m grønn	07-510-305	1	
	Torx M8x35 Torx M8x50	04-000-035 04-000-050	8 2	
	Låsemutter M8	04-040-008	6	
	Skive M8	04-050-008	10	
	Brikke 120 3xM8	04-060-120	2	

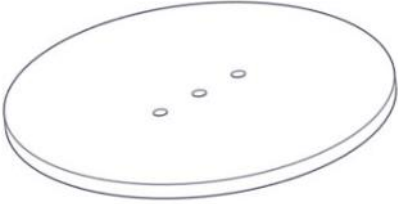
Boltepakker for / Boltpackage for / Bultpaket för		Sign. _____.		
Rutsjebane H55 07-510-305K grønn	Navn	Artnr/dimensjon	Ant	Lev
	Fundament Støp			
	Stålforankring lang L=600mm	00-100-316	2	
	Fundament Nedgraving			
	Stålforankring Lengde = 600mm	00-100-316	2	
	Fundamentplate Rund	00-003-103	2	