

N**Monteringsanvisning****EN****Assembly Instructions****S****Monteringsanvisning**

Produkt nr. / Product no. / Produkt nr.

07-510-512K**Rød**

Ord. nr. _____

Dato. _____

Sign. _____

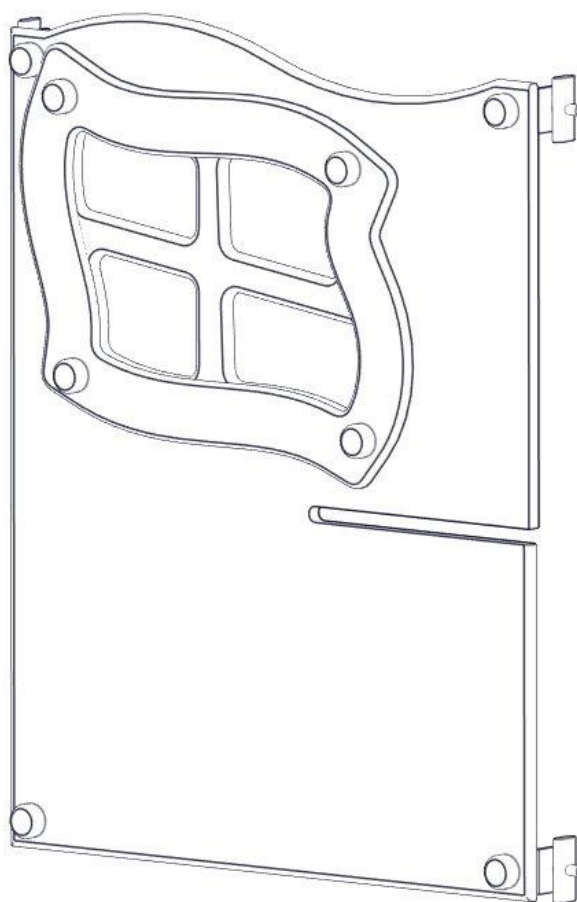
**sove**





Søve AS
Grønnvoldveien 290
3830 Ulefoss - Norway
Tlf: +47 35 94 65 65
www.sove.no

**sove**

Søve AB
EA Rosengrensgatan 32
421 31 Västra Frölunda
Phone: +46 (0)31 773 97 00
www.sove.se

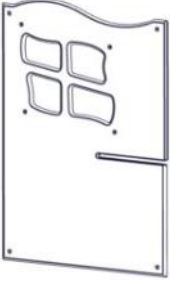
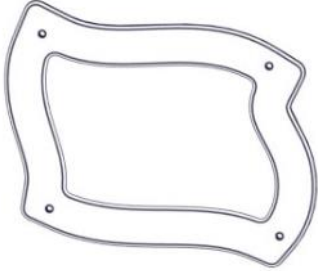

Boltepakker for / Boltpackage for / Bultpaket för

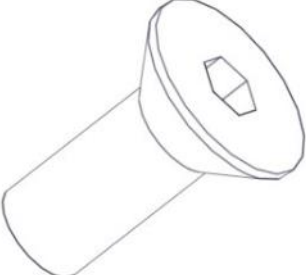
Sign. _____

| Vegg 520 x635 m/ vindu, spor 07-510-512K | Navn | Artnr/ dimensjon | Ant | Lev |
|---|---|---------------------|-----|-----|
|  | Vegg Med vindu, spor 520 x 635 Rød | 07-510-512 | 1 | |
|  | Vinduskarm Til vegg 520 x 635 Hvit | 07-510-553 | 1 | |
|  | Endedeksel flat M8 Kropp Sort | 05-301-033 | 8 | |
|  | Endedeksel flat M8 Hode Sort | 05-301-033 | 8 | |
|  | Låsemutter M8 | 04-040-008 | 8 | |
|  | Unbrako M8x30 forsenket | 04-034-030 | 4 | |

Boltepakker for / Boltpackage for / Bultpaket för

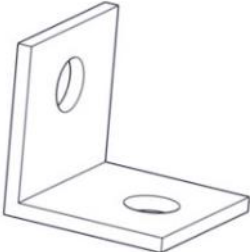
Sign. _____.

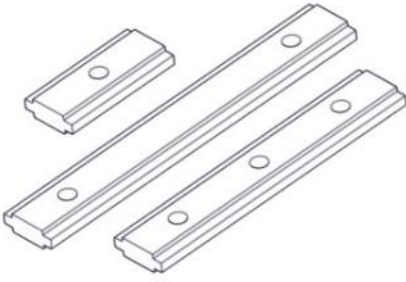
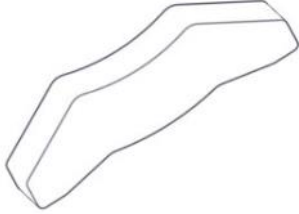
| Vegg 520 x635 m/ vindu, spor 07-510-512K | Navn | Artnr/ dimensjon | Ant | Lev |
|---|---|---------------------|-----|-----|
|  | Vinkel 35 x 35 x 35 x 3 11mm hull | 04-070-036 | 4 | |
|  | Torx M8x25 | 04-000-025 | 8 | |
|  | Brikke 50 1xM8 | 04-060-050 | 4 | |
|  | Plugg stolpespor | 00-400-980 | 1 | |
| | | | | |
| | | | | |

Montering av lekeapparatet / Assembly instructions / Montering av lekredskapet

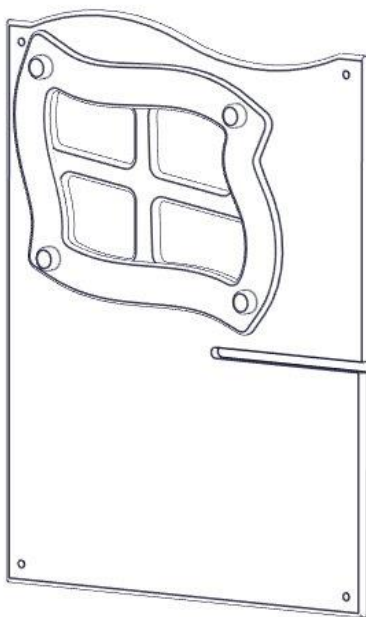

| nr | PartName | Artnr | Antall |
|----|------------------------------------|------------|--------|
| 1 | Vegg 520x665 m vindu, spor | 07-510-512 | 1 |
| 2 | Vinduskarm vegg 520x665 | 07-510-553 | 1 |
| 3 | Endedeksel flat M8 sort hode | 05-301-033 | 4 |
| 4 | Endedeksel flat M8 sort kropp | 05-301-033 | 4 |
| 5 | Låsemutter M8 | 04-040-008 | 4 |
| 6 | Unbrako skrue M8x30 forsenket hode | 04-034-030 | 4 |

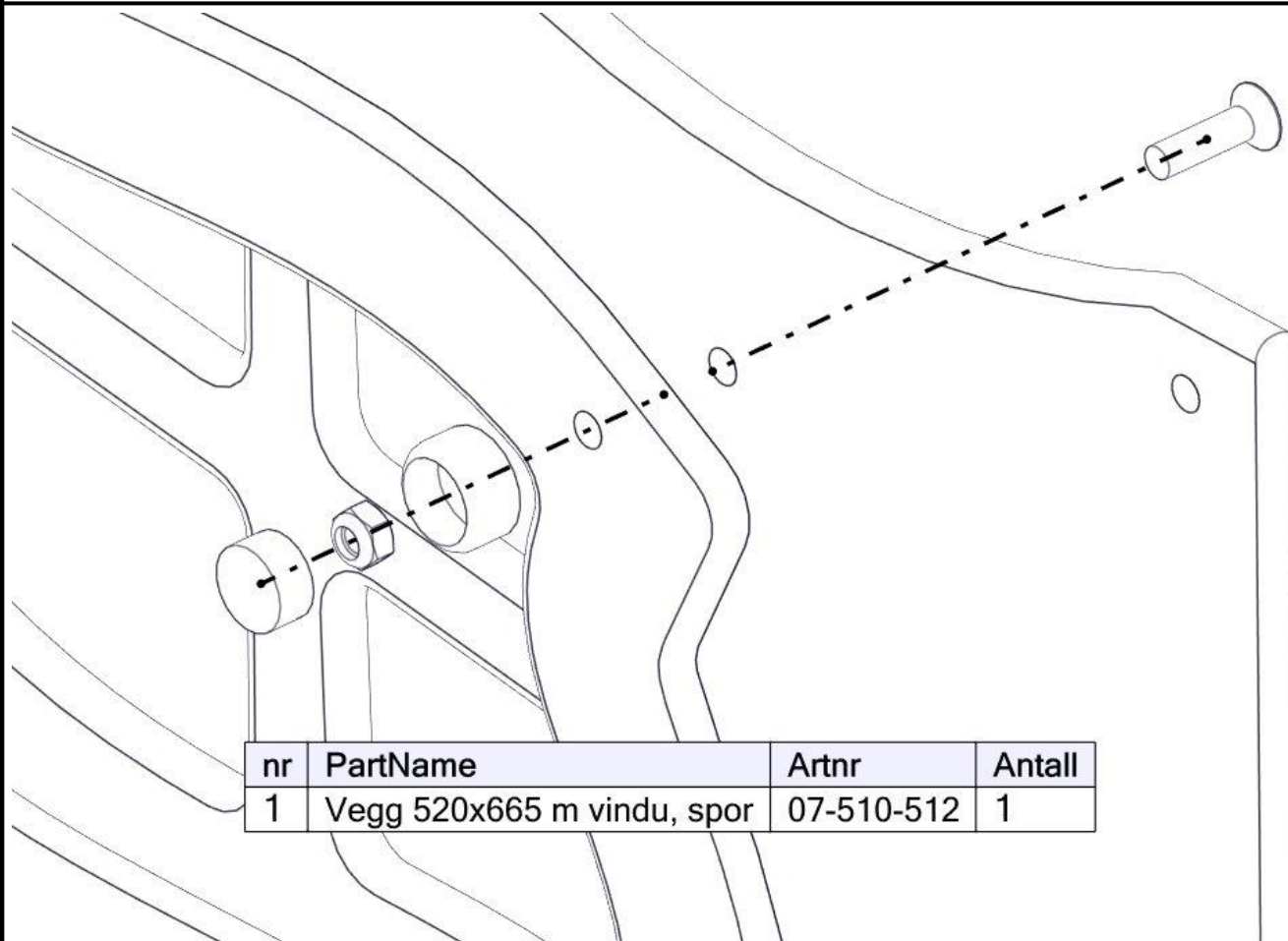

| nr | PartName | Artnr | Antall |
|----|----------------------------|------------|--------|
| 1 | Vegg 520x665 m vindu, spor | 07-510-512 | 1 |

Montering av lekeapparatet / Assembly instructions / Montering av lekredskapet

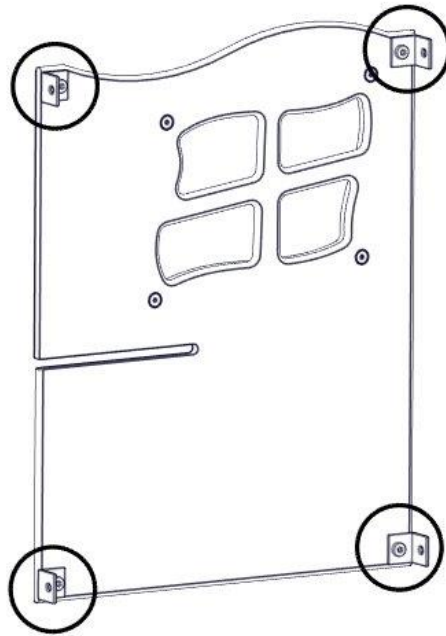

| nr | PartName | Artnr | Antall |
|----|-------------------------------|------------|--------|
| 1 | Endedeksel flat M8 sort kropp | 05-301-033 | 4 |
| 2 | Låsemutter M8 | 04-040-008 | 4 |
| 3 | Torx M8x25 | 04-000-025 | 4 |
| 4 | Vinkel 35x35x35x3 11mm hull | 04-070-036 | 4 |

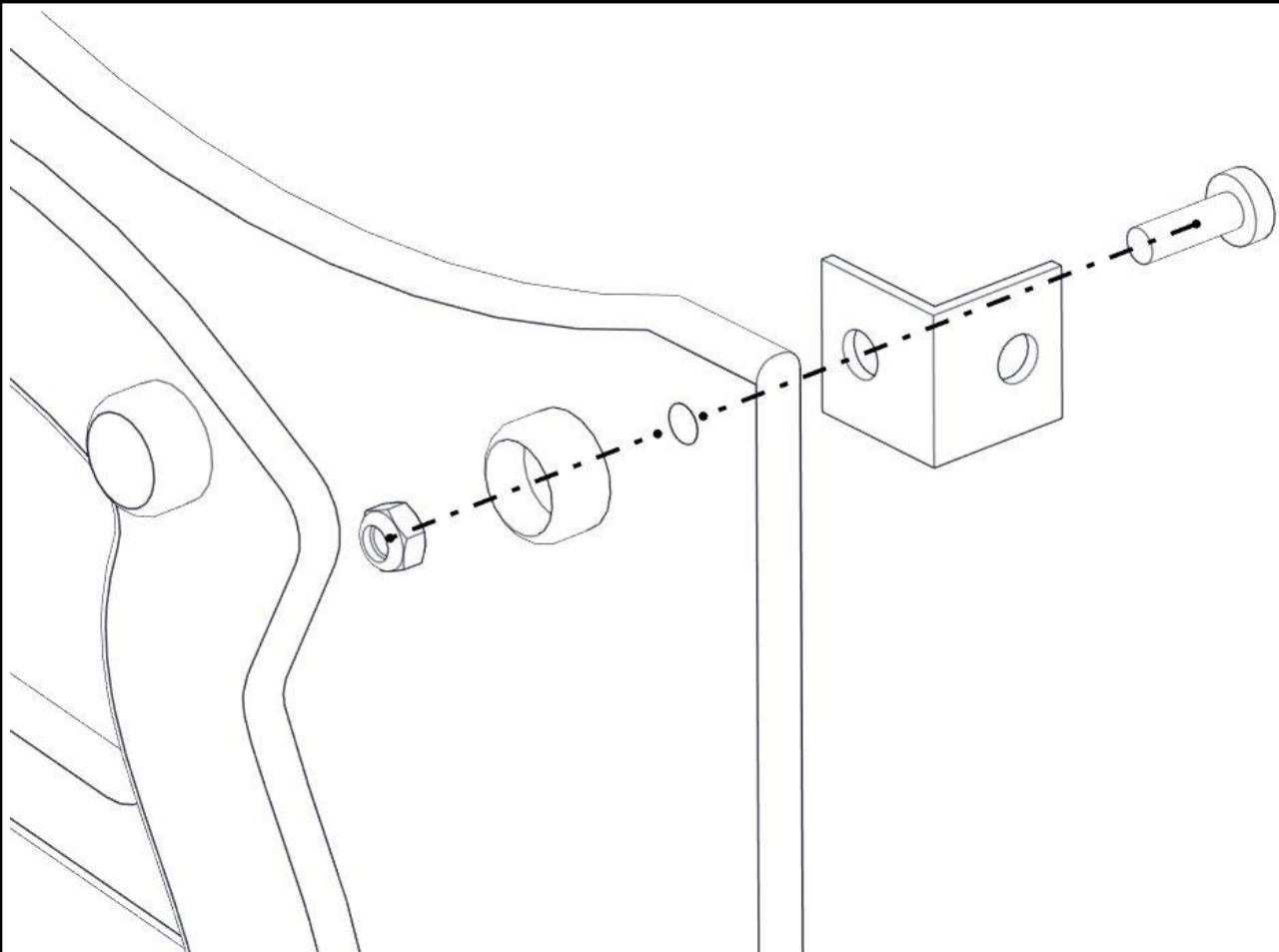



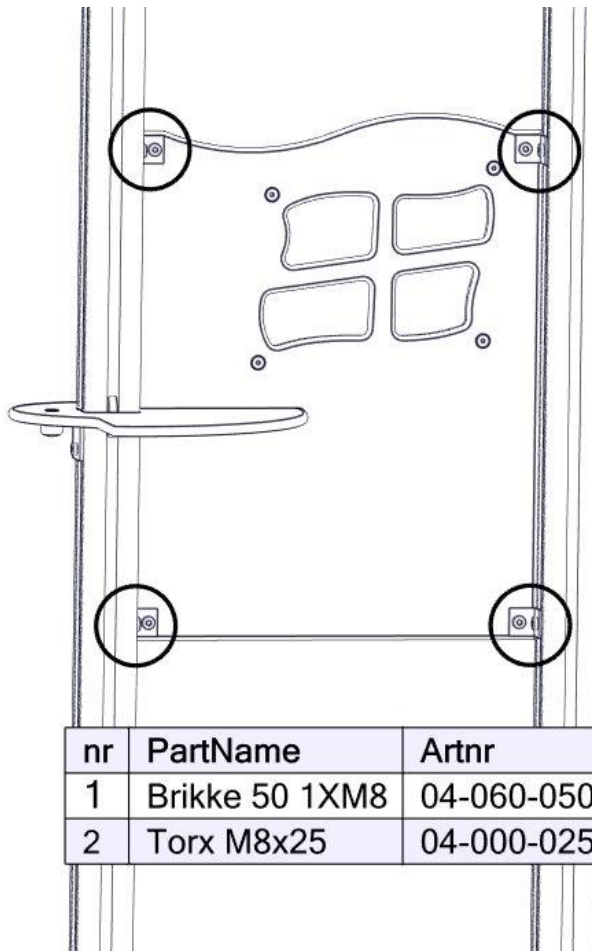

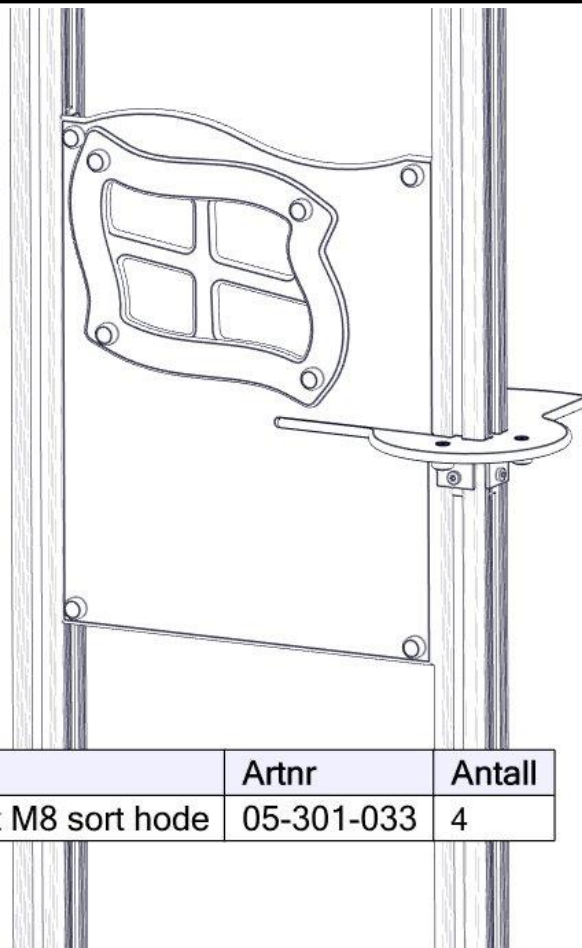
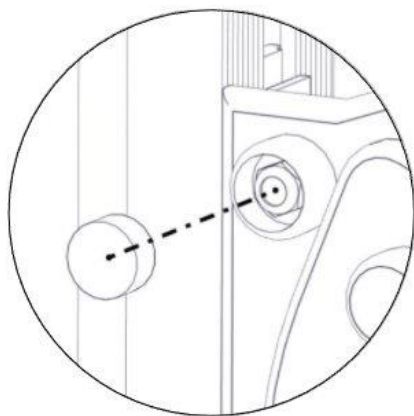
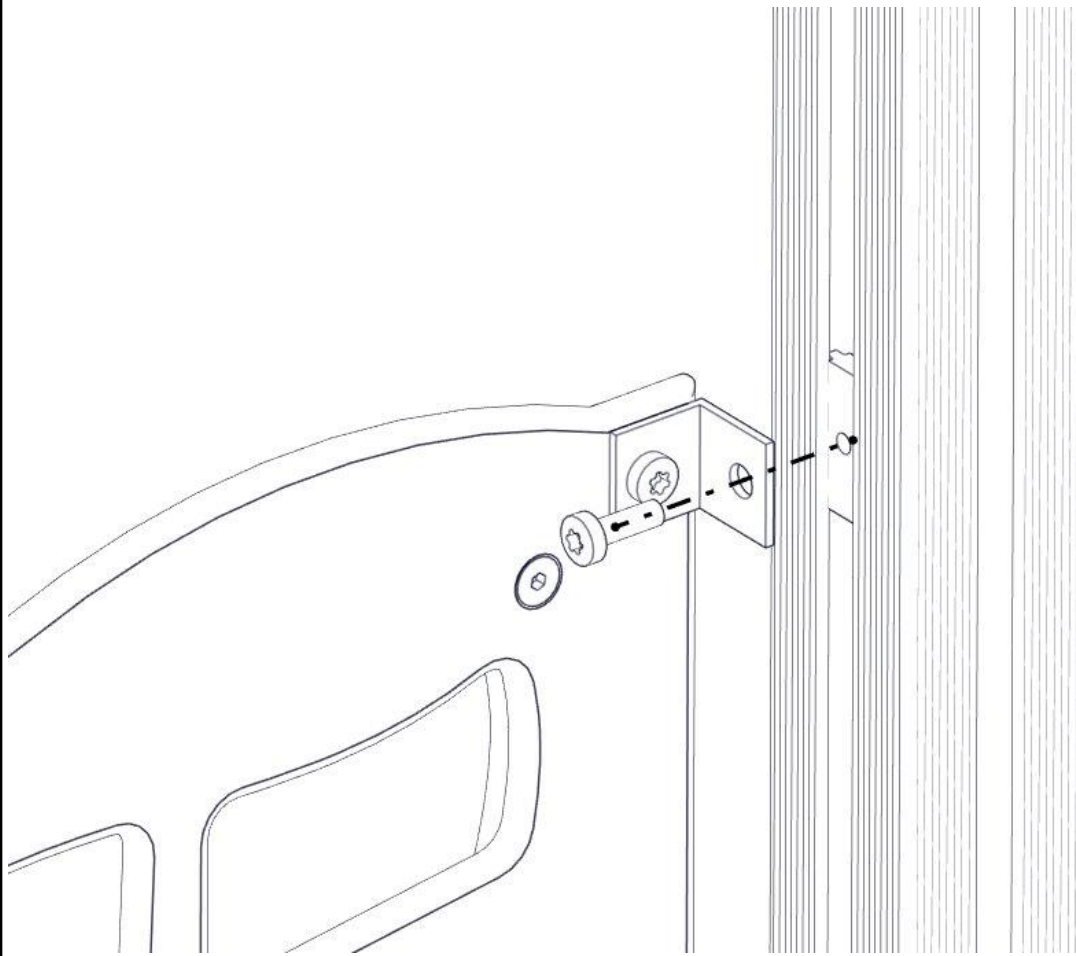
Montering av lekeapparatet / Assembly instructions / Montering av lekredskapet

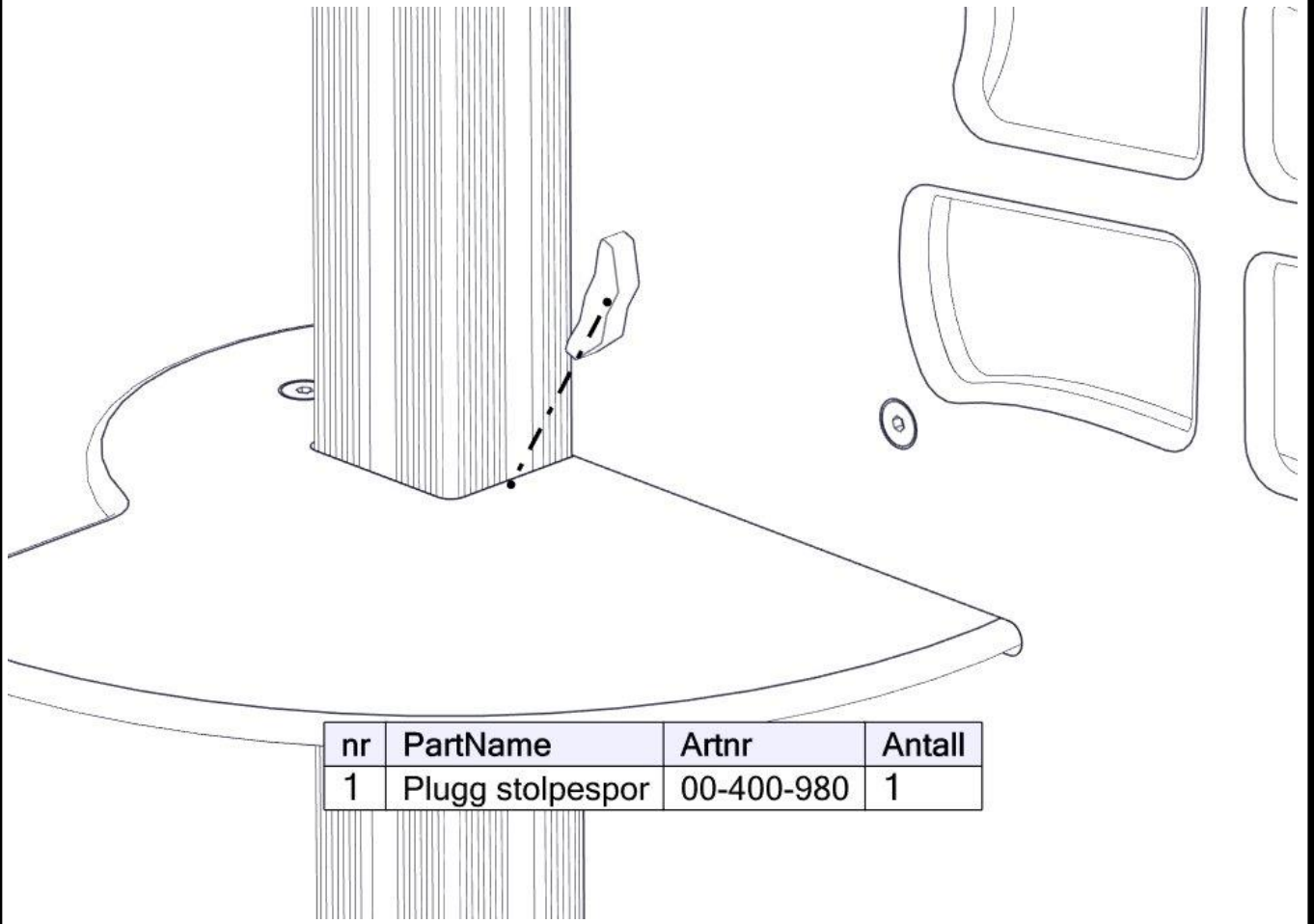

Montering av lekeapparatet / Assembly instructions / Montering av lekredskapet

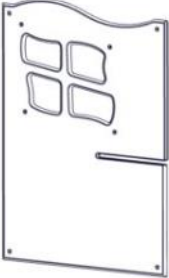
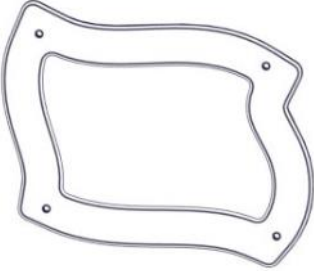

| nr | PartName | Artnr | Antall |
|----|------------------------------|------------|--------|
| 1 | Endedeksel flat M8 sort hode | 05-301-033 | 4 |

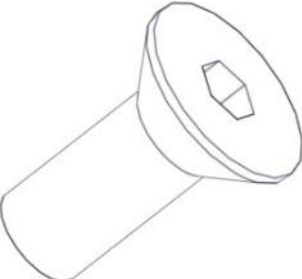
Montering av lekeapparatet / Assembly instructions / Montering av lekredskapet

| Boltepakker for / Boltpackage for / Bultpaket för | | Sign. _____ | | |
|---|---|-----------------------------|------------|------------|
| Vegg 520 x635 m/ vindu, spor 07-510-512K | Navn | Artnr/ dimensjon | Ant | Lev |
|  | Vegg Med vindu, spor 520 x 635 Rød | 07-510-512 | 1 | |
|  | Vinduskarm Til vegg 520 x 635 Hvit | 07-510-553 | 1 | |
|  | Endedeksel flat M8 Kropp Sort | 05-301-033 | 8 | |
|  | Endedeksel flat M8 Hode Sort | 05-301-033 | 8 | |
|  | Låsemutter M8 | 04-040-008 | 8 | |
|  | Unbrako M8x30 forsenket | 04-034-030 | 4 | |

Boltepakker for / Boltpackage for / Bultpaket för

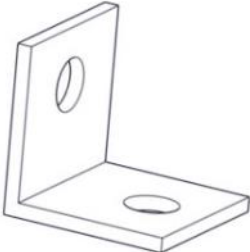
Sign. _____

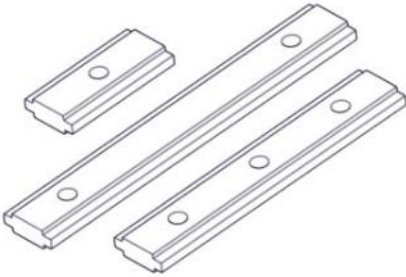
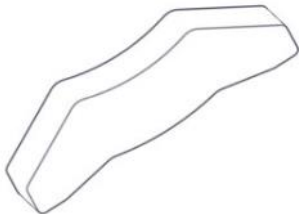
| Vegg 520 x635 m/ vindu, spor 07-510-512K | Navn | Artnr/ dimensjon | Ant | Lev |
|---|---|---------------------|-----|-----|
|  | Vinkel 35 x 35 x 35 x 3 11mm hull | 04-070-036 | 4 | |
|  | Torx M8x25 | 04-000-025 | 8 | |
|  | Brikke 50 1xM8 | 04-060-050 | 4 | |
|  | Plugg stolpespor | 00-400-980 | 1 | |
| | | | | |
| | | | | |