

N

Monteringsanvisning

EN

Assembly Instructions

S

Monteringsanvisning

Produkt nr. / Product no. / Produkt nr.

07-510-515K**Trestruktur**

Ord. nr. _____

Dato. _____

Sign. _____

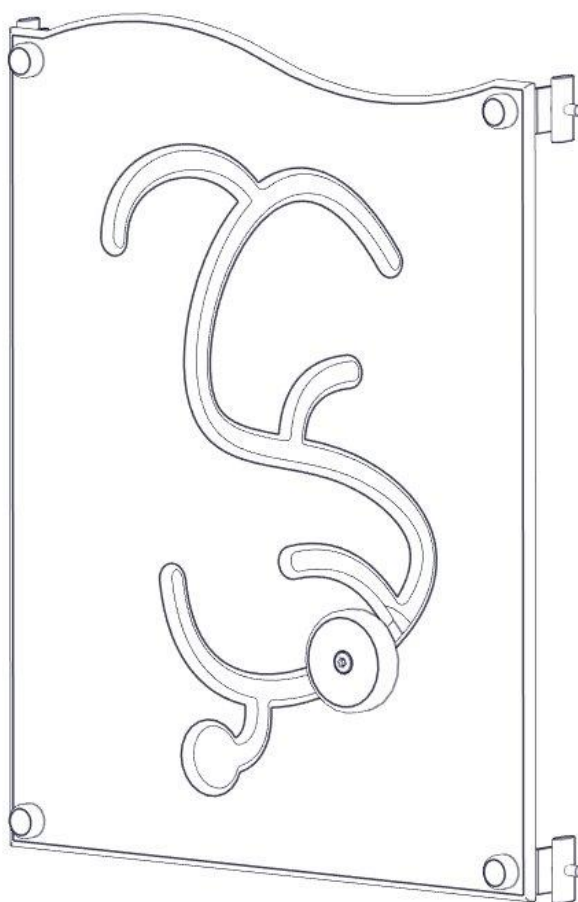
**søve**







Søve AS
Grønnvoldveien 290
3830 Ulefoss - Norway
Tlf: +47 35 94 65 65
www.sove.no

**søve**

Søve AB
EA Rosengrensgatan 32
421 31 Västra Frölunda
Phone: +46 (0)31 773 97 00
www.sove.se

Boltepakker for / Boltpackage for / Bultpaket för

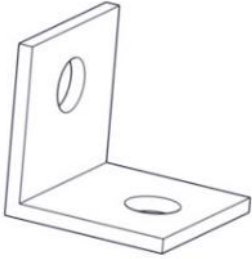
Sign. _____

Vegg 520 x635 m/ spill 07-510-515K	Navn	Artnr/ dimensjon	Ant	Lev
	Vegg Til spill 520 x 635 Trestruktur	07-510-515	1	
	Endedeksel flat M8 Kropp Sort	05-301-033	4	
	Endedeksel flat M8 Hode Sort	05-301-033	4	
	Låsemutter M8	04-040-008	4	
	Vinkel 35 x 35 x 35 x 3 11mm hull	04-070-036	4	
	Torx M8x25	04-000-025	8	

Boltepakker for / Boltpackage for / Bultpaket för

Sign. _____.

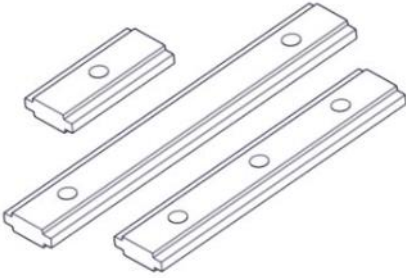
Vegg 520 x635 m/ spill 07-510-515K	Navn	Artnr/ dimensjon	Ant	Lev
	Brikke 50 1xM8	04-060-050	4	

Montering av lekeapparatet / Assembly instructions / Montering av lekredskapet

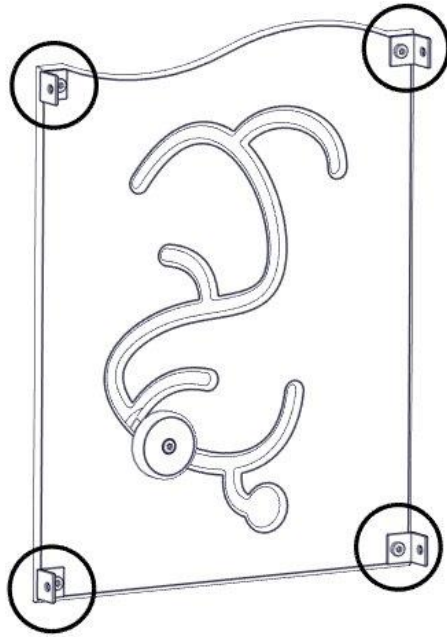

nr	PartName	Artnr	Antall
1	Vegg 520x665 med spill	07-510-515	1
2	Endedeksel flat M8 sort hode	05-301-033	4
3	Endedeksel flat M8 sort kropp	05-301-033	4
4	Låsemutter M8	04-040-008	4
5	Torx M8x25	04-000-025	4

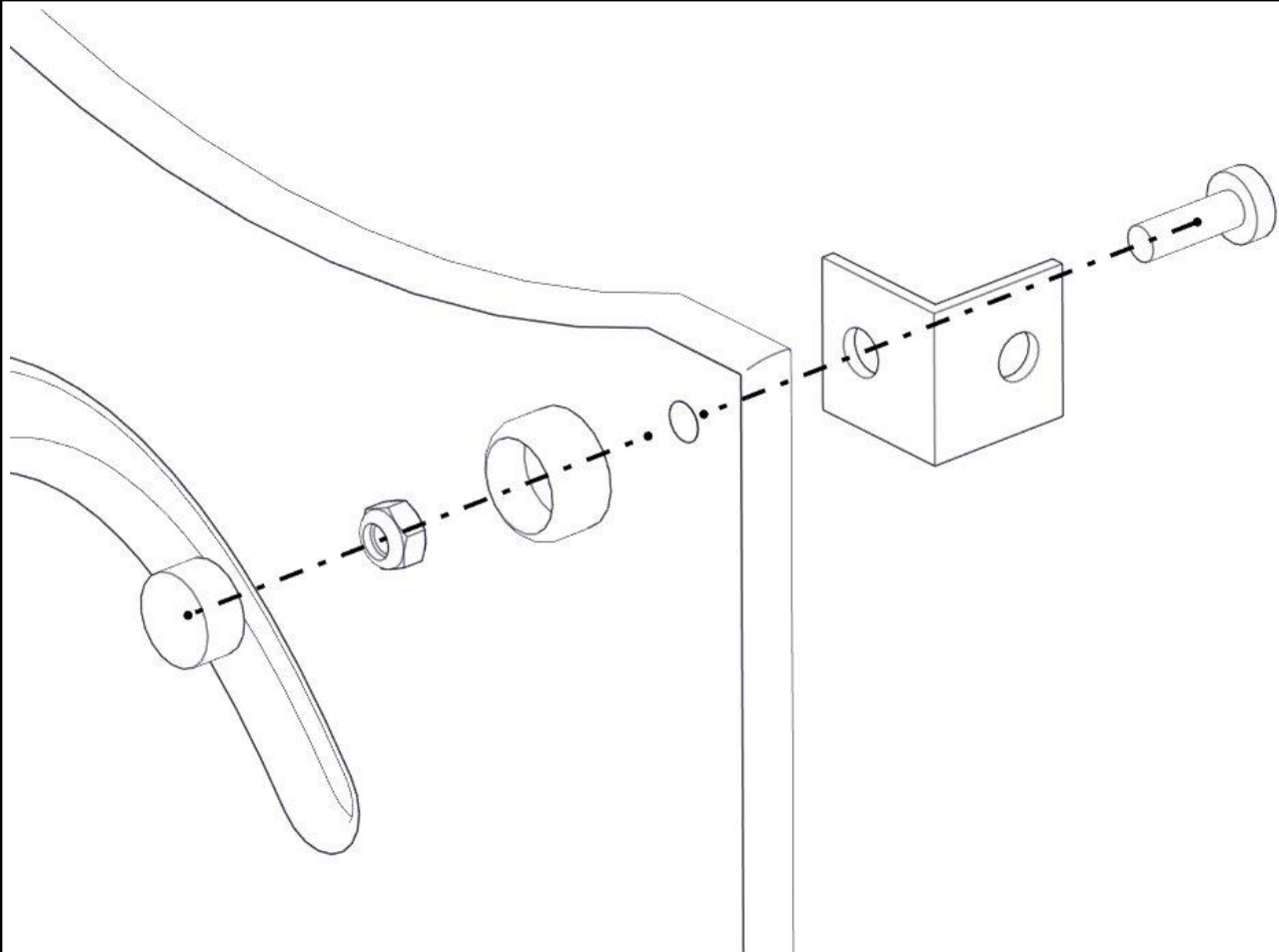

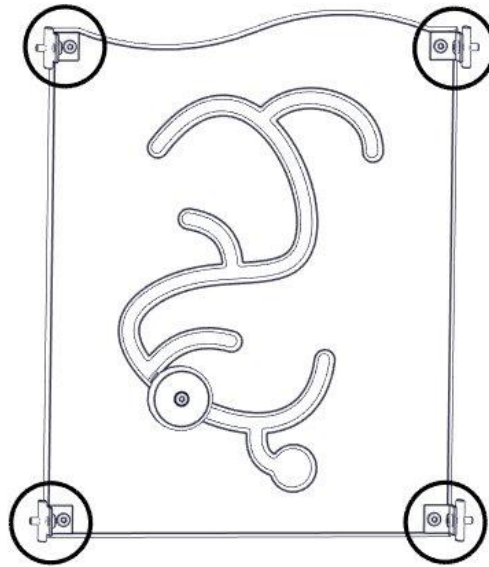
Montering av lekeapparatet / Assembly instructions / Montering av lekredskapet

nr	PartName	Artnr	Antall
1	Brikke 50 1XM8	04-060-050	4
2	Torx M8x25	04-000-025	4

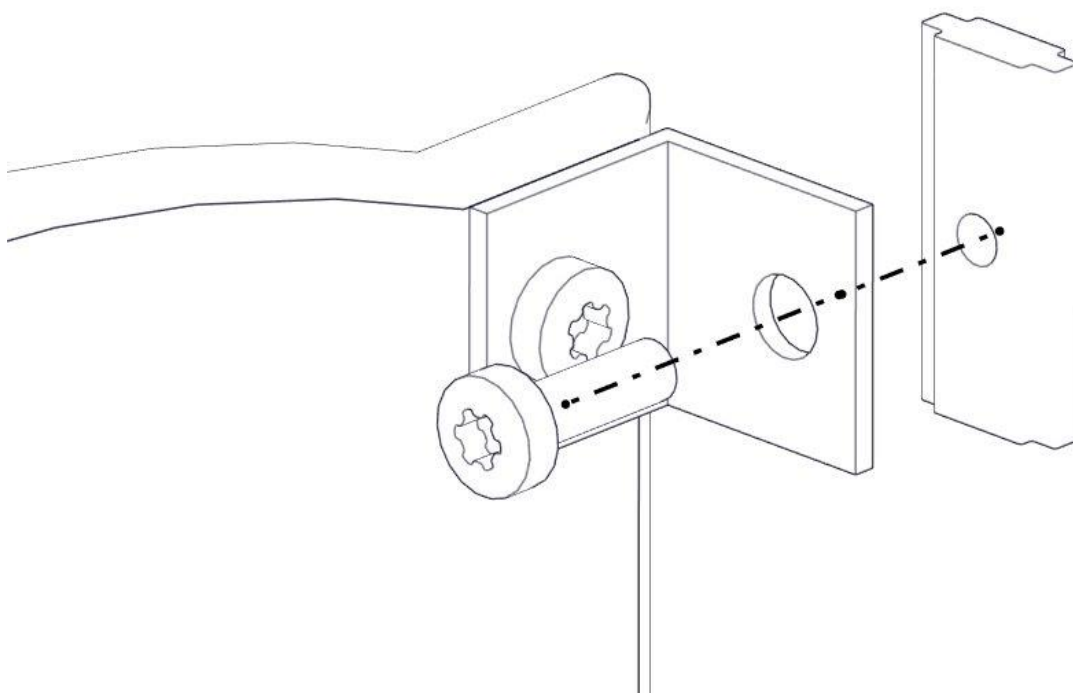

Montering av lekeapparatet / Assembly instructions / Montering av lekredskapet

Se på hovedmontering for posisjon
Look at main assembly for position
Titta på hovudmontering for posisjon

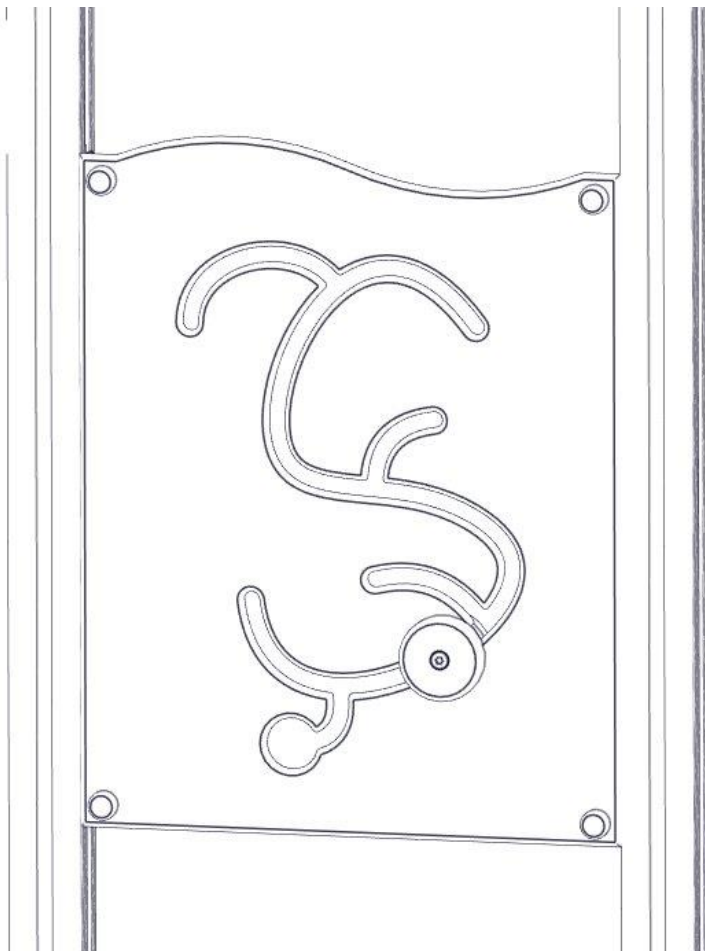



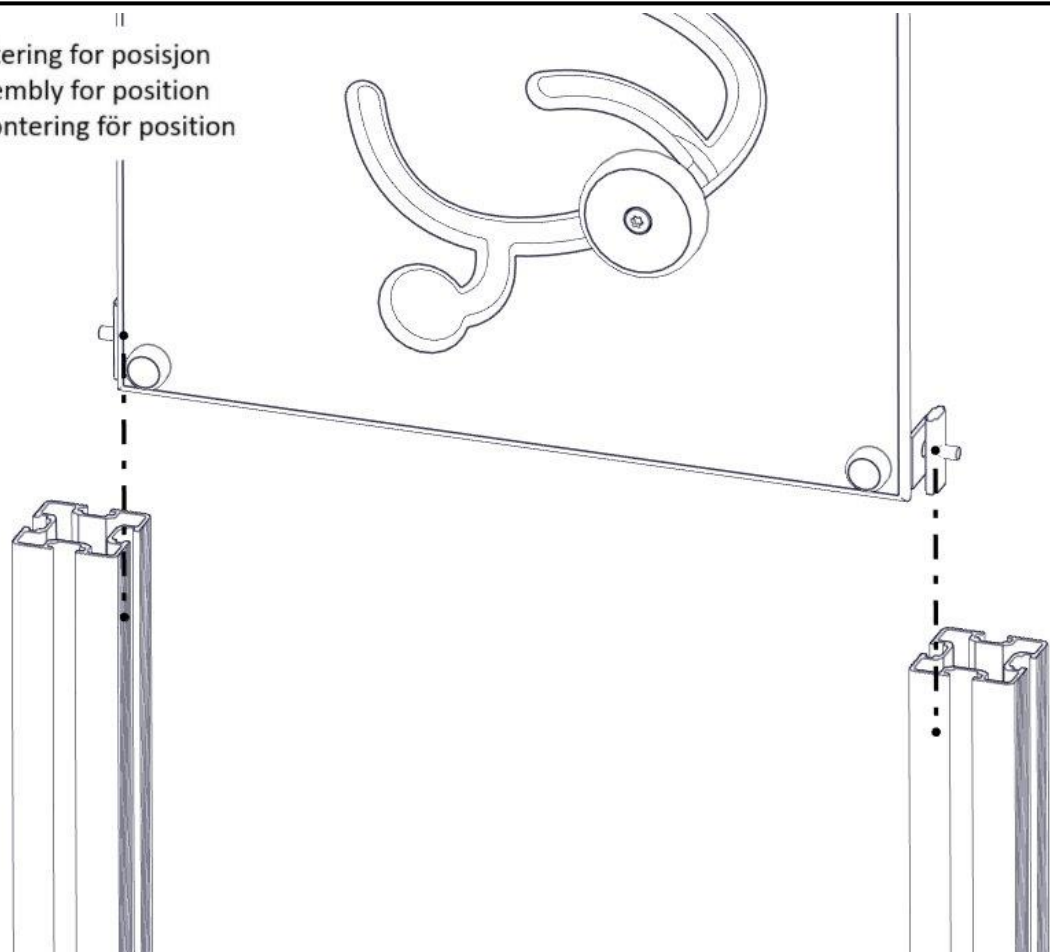



Se på hovedmontering for posisjon
Look at main assembly for position
Titta på hovudmontering for posisjon

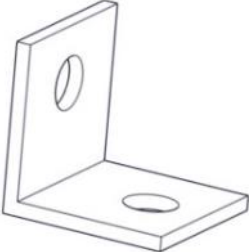

Boltepakker for / Boltpackage for / Bultpaket för

Sign. _____

Vegg 520 x635 m/ spill 07-510-515K	Navn	Artnr/ dimensjon	Ant	Lev
	Vegg Til spill 520 x 635 Trestruktur	07-510-515	1	
	Endedeksel flat M8 Kropp Sort	05-301-033	4	
	Endedeksel flat M8 Hode Sort	05-301-033	4	
	Låsemutter M8	04-040-008	4	
	Vinkel 35 x 35 x 35 x 3 11mm hull	04-070-036	4	
	Torx M8x25	04-000-025	8	

Boltepakker for / Boltpackage for / Bultpaket för

Sign. _____.

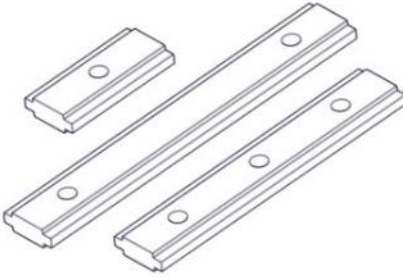
Vegg 520 x635 m/ spill 07-510-515K	Navn	Artnr/ dimensjon	Ant	Lev
	Brikke 50 1xM8	04-060-050	4	