

**N****Monteringsanvisning****EN****Assembly Instructions****S****Monteringsanvisning**

Produkt nr. / Product no. / Produkt nr.

**07-510-616K****Gul**

Ord. nr. \_\_\_\_\_

Dato. \_\_\_\_\_



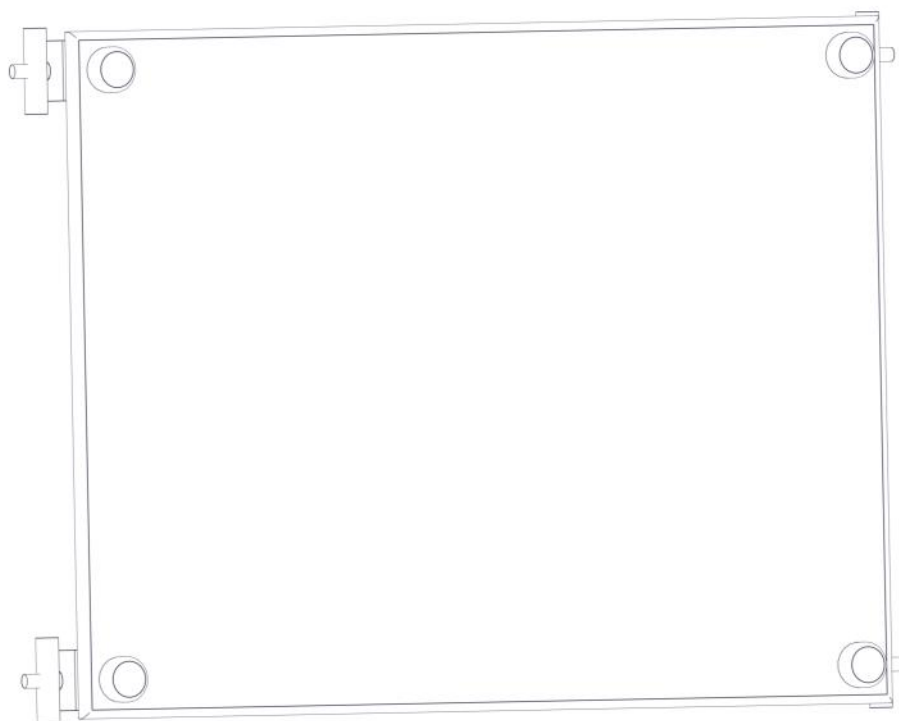

Sign. \_\_\_\_\_



Søve AS  
Grønnvoldveien 290  
3830 Ulefoss - Norway  
Tlf: +47 35 94 65 65  
[www.sove.no](http://www.sove.no)

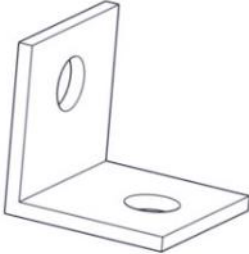

Søve AB  
EA Rosengrensgatan 32  
421 31 Västra Frölunda  
Phone: +46 (0)31 773 97 00  
[www.sove.se](http://www.sove.se)

<b>Boltepakker for / Boltpackage for / Bultpaket för</b>		Sign. _____		
<b>Vegg 520 x 400 standard 07-510-616K</b>	<b>Navn</b>	<b>Artnr/ dimensjon</b>	<b>Ant</b>	<b>Lev</b>
	Vegg standard 520 x 400 Gul	07-510-616	1	
	Endedeksel flat M8 kropp Sort	05-301-033	4	
	Endedeksel flat M8 hode Sort	05-301-033	4	
	Vinkel 35 x 35 x 35 x 3 11mm hull	04-070-036	4	
	Torx M8x25	04-000-025	4	
	Torx M8x30	04-000-030	4	
	Låsemutter M8	04-040-008	4	

**Boltepakker for / Boltpackage for / Bultpaket för**

Sign. \_\_\_\_\_.

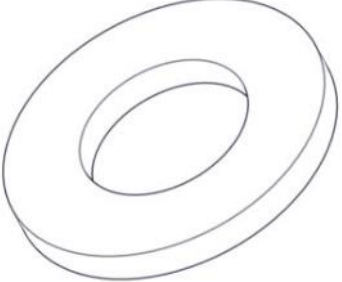
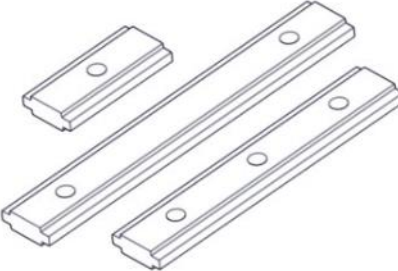
Vegg 520 x 400 standard 07-510-616K	Navn	Artnr/ dimensjon	Ant	Lev
	Skive M8	04-050-008	8	
	Brikke 50 1xM8	04-060-050	4	

## Montering av lekeapparatet / Assembly instructions / Montering av lekredskapet

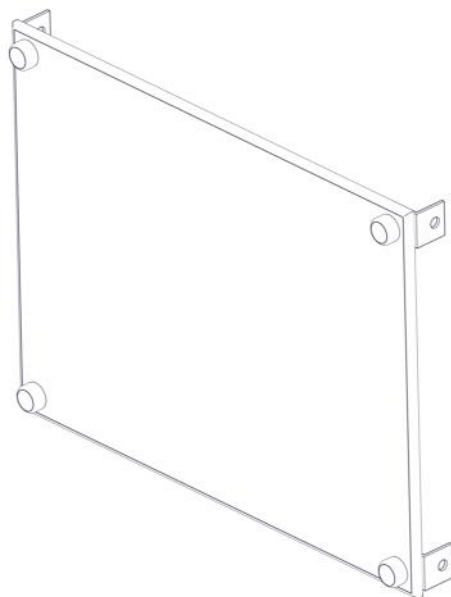

PartName	Artnr	Antall
Endedeksel flat M8 sort hode	05-301-033	4
Endedeksel flat M8 sort kropp	05-301-033	4
Låsemutter M8	04-040-008	4
Skive M8	04-050-008	8

PartName	Artnr	Antall
Torx M8x30	04-000-030	4
Vegg 520x400	07-510-616	1
Vinkel 35x35x35x3 11mm hull	04-070-036	4

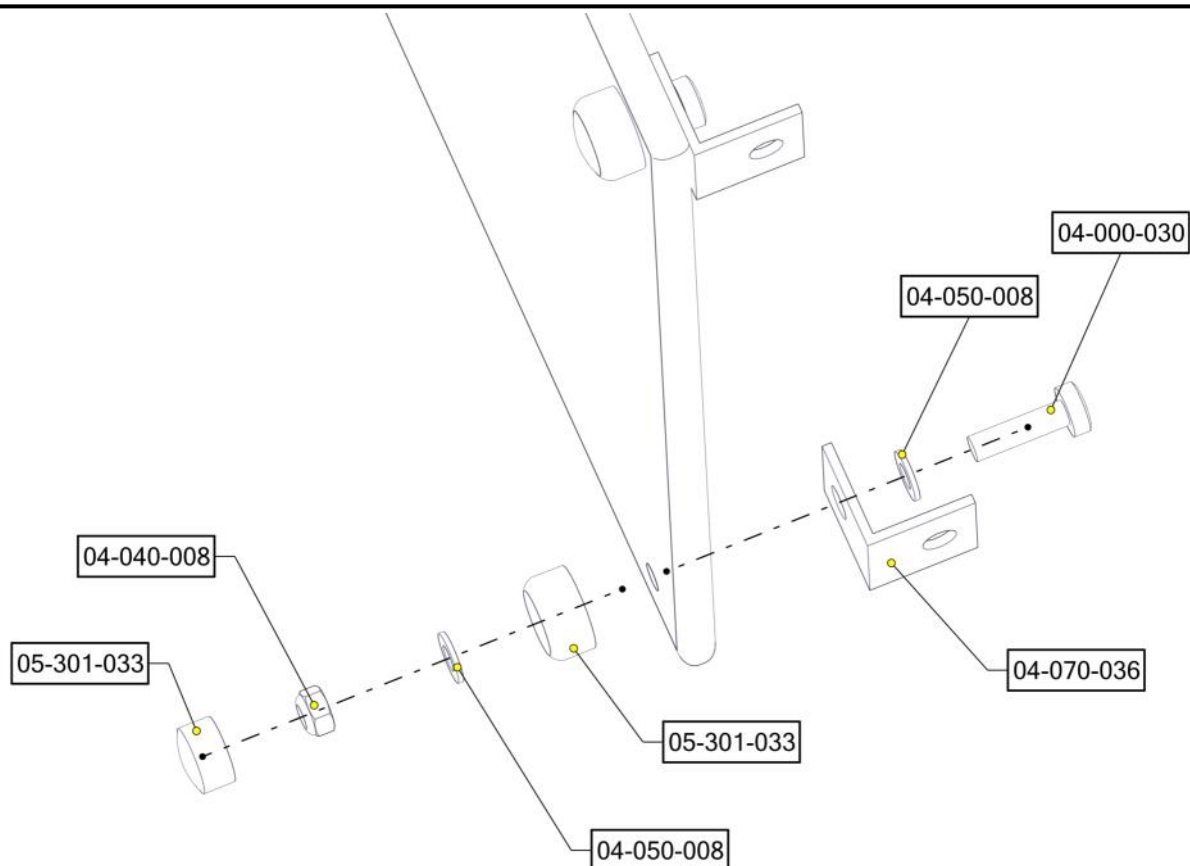

## Montering av lekeapparatet / Assembly instructions / Montering av lekredskapet

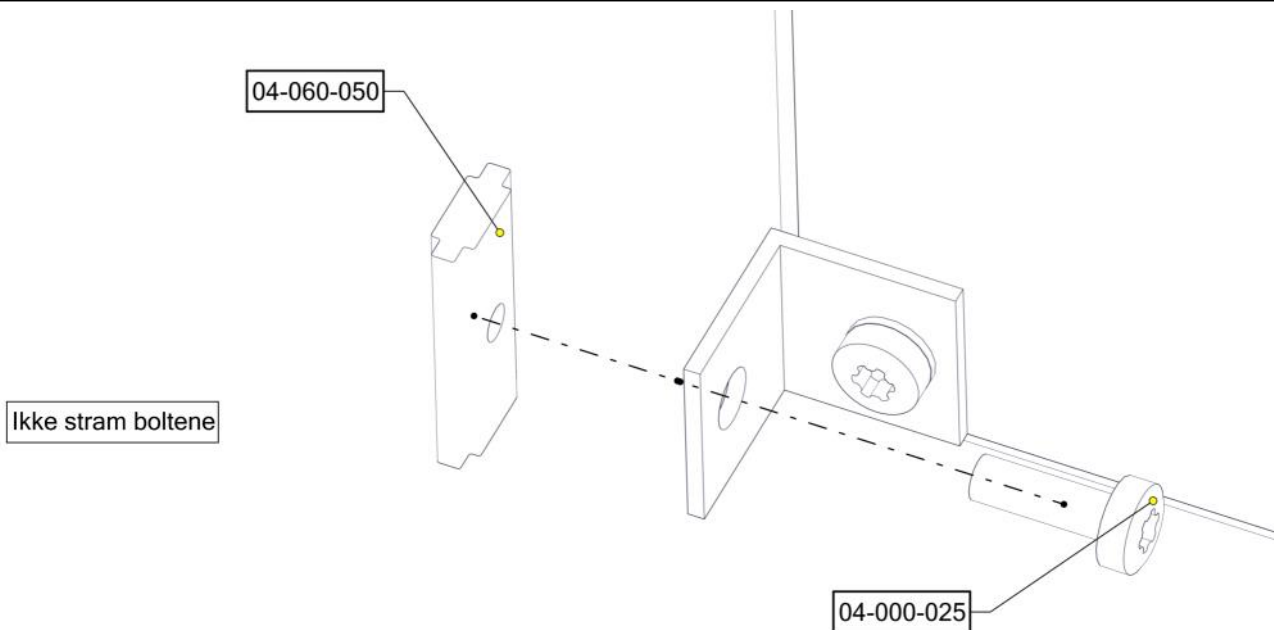





PartName	Artnr	Antall
Brikke 50 1XM8	04-060-050	4
Torx M8x25	04-000-025	4



Se på hovedmontering for posisjon  
 Look at main assembly for position  
 Titta på hovudmontering för position

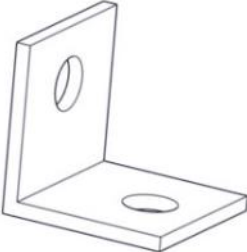

<b>Boltepakker for / Boltpackage for / Bultpaket för</b>		Sign. _____		
<b>Vegg 520 x 400 standard 07-510-616K</b>	<b>Navn</b>	<b>Artnr/ dimensjon</b>	<b>Ant</b>	<b>Lev</b>
	Vegg standard 520 x 400 Gul	07-510-616	1	
	Endedeksel flat M8 kropp Sort	05-301-033	4	
	Endedeksel flat M8 hode Sort	05-301-033	4	
	Vinkel 35 x 35 x 35 x 3 11mm hull	04-070-036	4	
	Torx M8x25	04-000-025	4	
	Torx M8x30	04-000-030	4	
	Låsemutter M8	04-040-008	4	

**Boltepakker for / Boltpackage for / Bultpaket för**

Sign. \_\_\_\_\_.

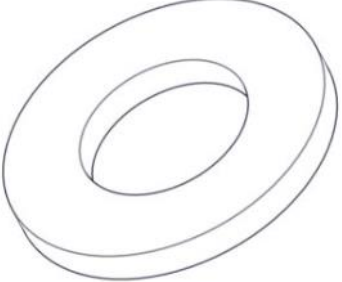
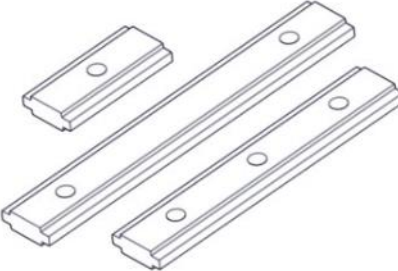
Vegg 520 x 400 standard 07-510-616K	Navn	Artnr/ dimensjon	Ant	Lev
	Skive M8	04-050-008	8	
	Brikke 50 1xM8	04-060-050	4	