

N**Monteringsanvisning****EN****Assembly Instructions****S****Monteringsanvisning**

Produkt nr. / Product no. / Produkt nr.

07-520-843K**Gul**

Ord. nr. _____

Dato. _____

Sign. _____

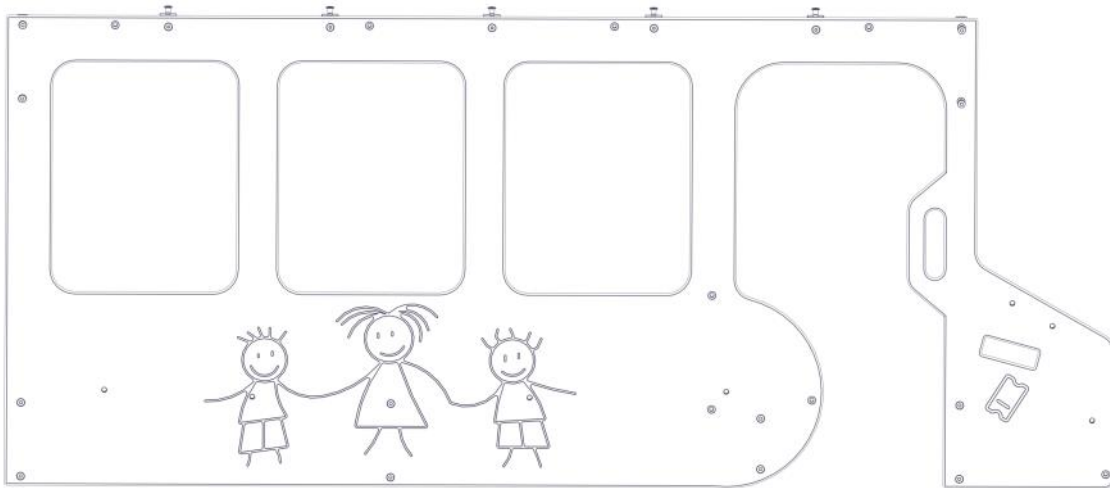
**søve**



Søve AS
Grønnvoldveien 290
3830 Ulefoss - Norway
Tlf: +47 35 94 65 65
www.sove.no



Søve AB
EA Rosengrensgatan 32
421 31 Västra Frölunda
Phone: +46 (0)31 773 97 00
www.sove.se

Boltepakker for / Boltpackage for / Bultpaket för

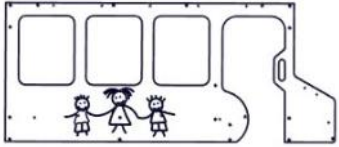
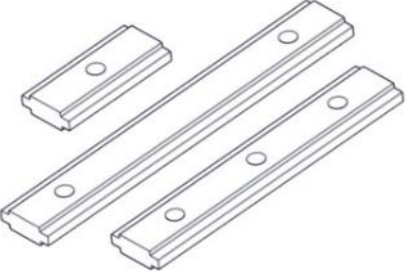
Sign. _____

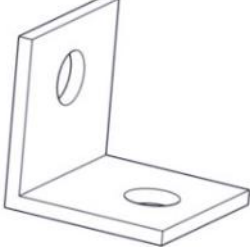
Side kort, buss 07-520-843K, Gul	Navn	Artnr/ dimensjon	Ant	Lev
	Side kort, buss HPL Gul	07-520-843	1	
	Brikke 200 2xM8 Brikke 150 2xM8	04-060-200 04-060-151	5 1	
	Torx M8x12 Torx M8x30	04-000-012 04-000-030	10 12	
	Møbelknapp M8x11	04-030-011	10	
	Vinkel 35x35x35x3 11mm hull	04-070-036	5	

Montering av lekeapparatet / Assembly instructions / Montering av lekredskapet

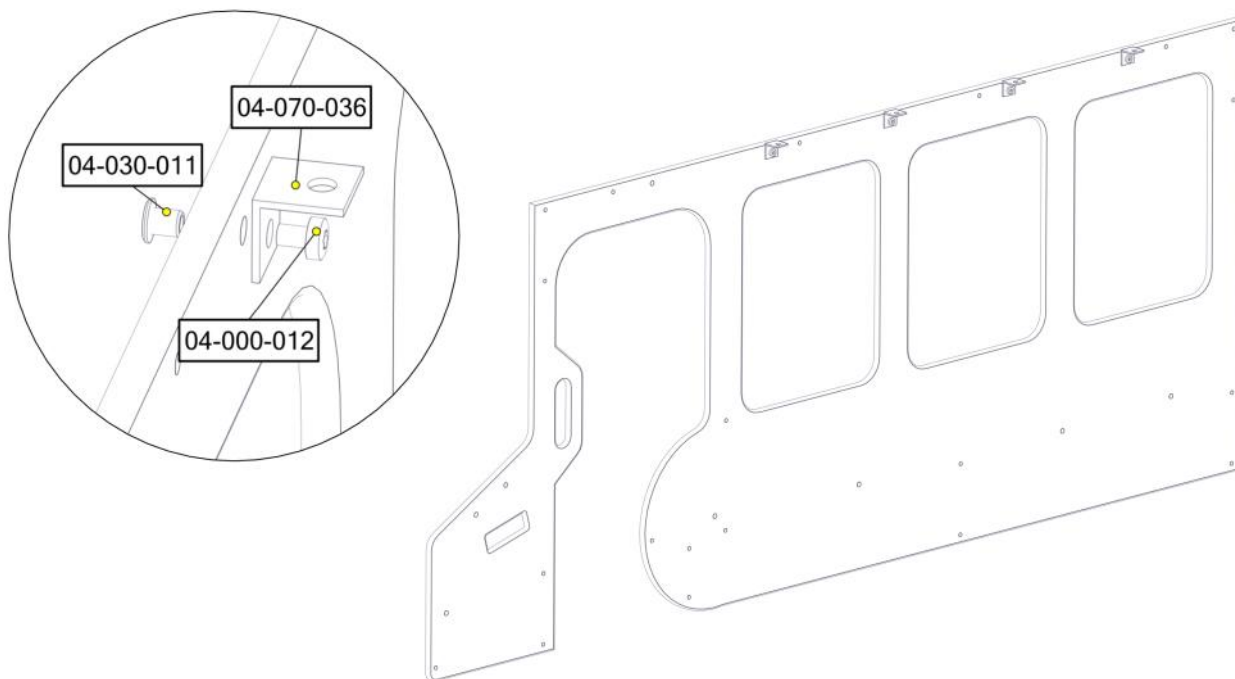

PartName	Artnr	Antall
Torx M8x12	04-000-012	4
Møbelknapp M8x11	04-030-011	4
Side-Left	07-520-843	1

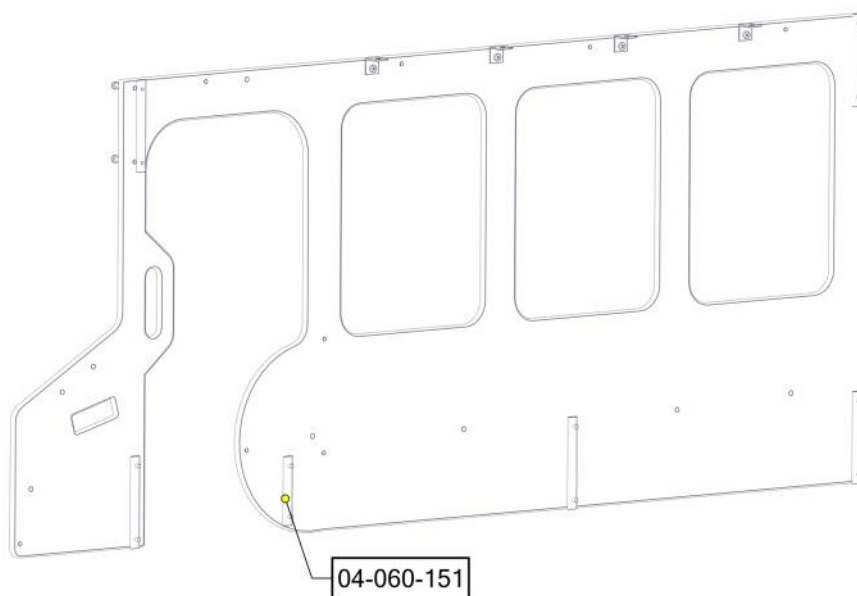

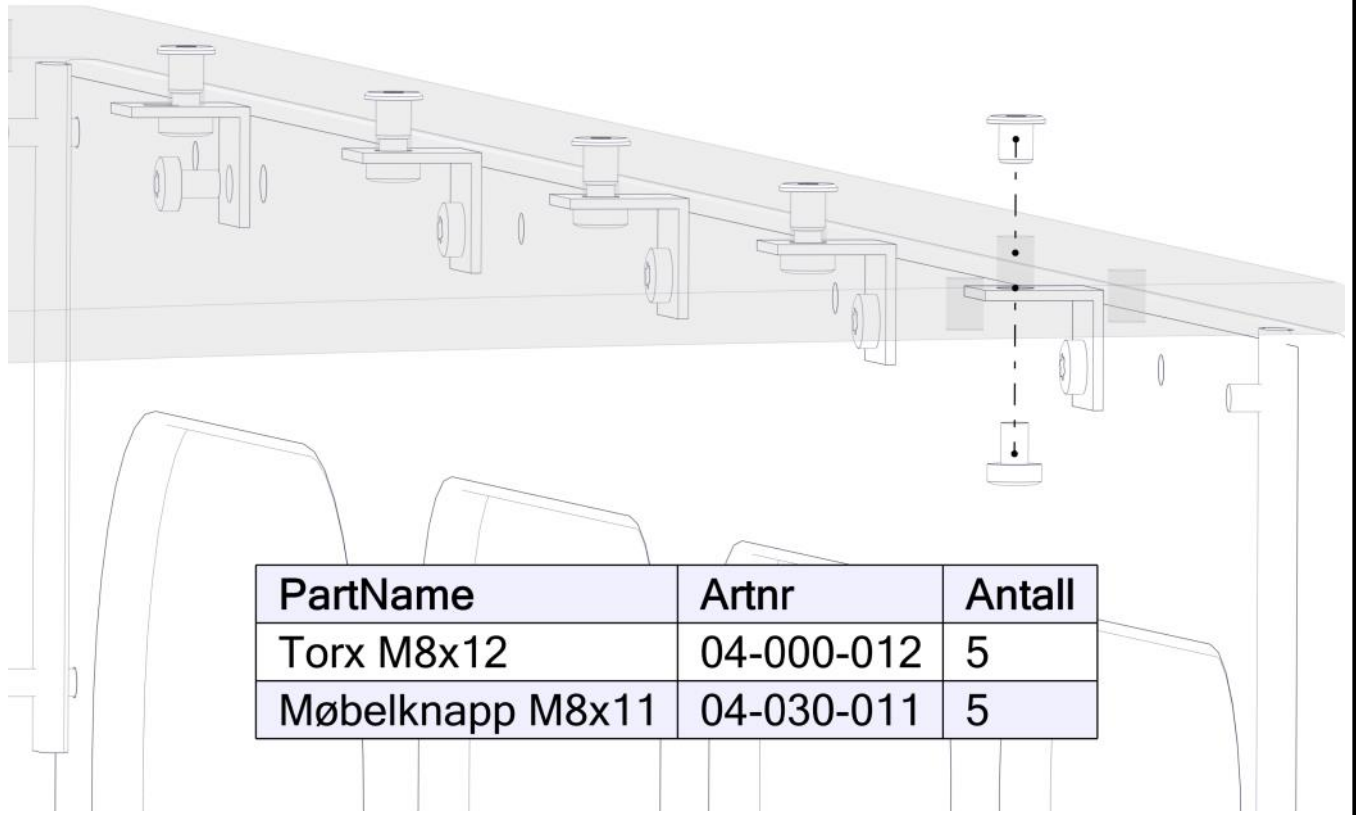

PartName	Artnr	Antall
Torx M8x30	04-000-030	12
Brikke 150 2xM8	04-060-151	1
Brikke 200 2xM8	04-060-200	5

Montering av lekeapparatet / Assembly instructions / Montering av lekredskapet

Boltepakker for / Boltpackage for / Bultpaket för

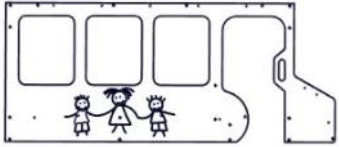
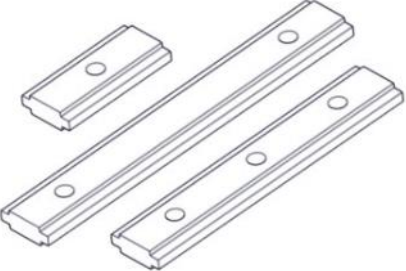
Sign. _____

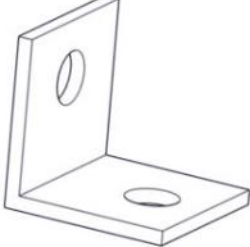
Side kort, buss 07-520-843K, Gul	Navn	Artnr/ dimensjon	Ant	Lev
	Side kort, buss HPL Gul	07-520-843	1	
	Brikke 200 2xM8 Brikke 150 2xM8	04-060-200 04-060-151	5 1	
	Torx M8x12 Torx M8x30	04-000-012 04-000-030	10 12	
	Møbelknapp M8x11	04-030-011	10	
	Vinkel 35x35x35x3 11mm hull	04-070-036	5	