

N**Monteringsanvisning****EN****Assembly Instructions****S****Monteringsanvisning**

Produkt nr. / Product no. / Produkt nr.

08-001-190K**Grå**

Ord. nr. _____

Dato. _____



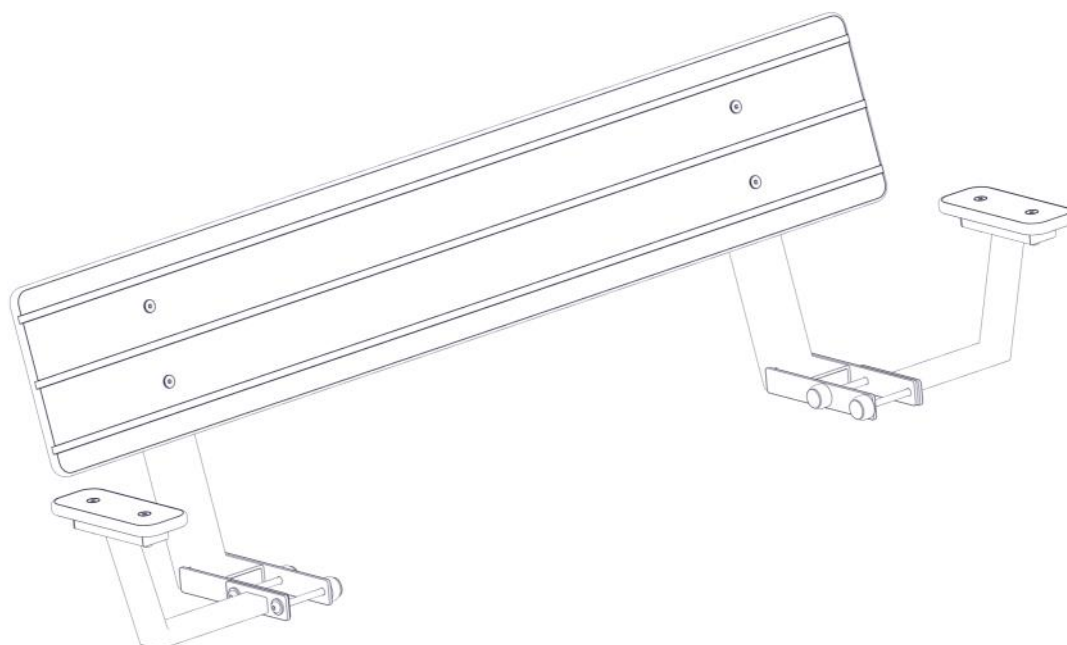

Sign. _____





Søve AS
Grønnvoldveien 290
3830 Ulefoss - Norway
Tlf: +47 35 94 65 65
www.sove.no

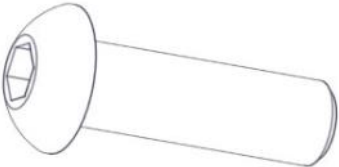
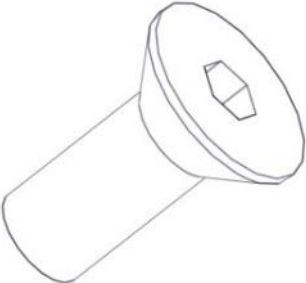

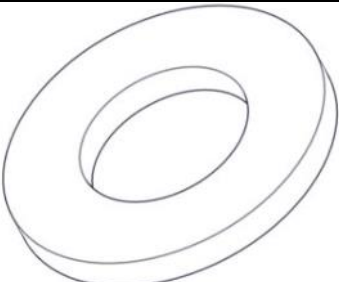

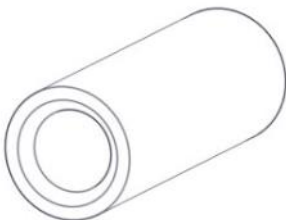
Søve AB
EA Rosengrensgatan 32
421 31 Västra Frölunda
Phone: +46 (0)31 773 97 00
www.sove.se

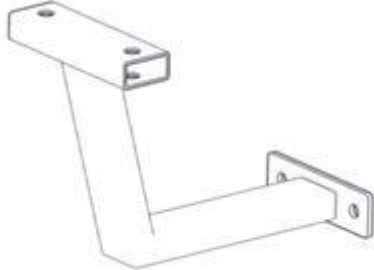
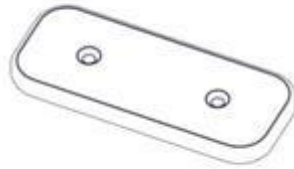
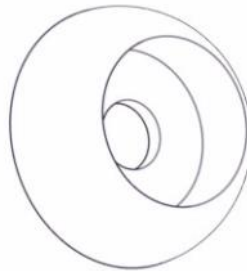
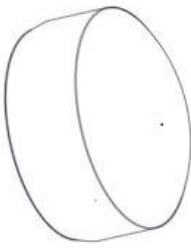
Boltepakker for / Boltpackage for / Bultpaket för		Sign. _____		
Arm og ryggstøtte 08-001-190K	Navn	Artnr/ dimensjon	Ant	Lev
	Benkeplate Grå	08-001-230	1	
	Ryggstøtte benk 81-200 Sort	08-001-180	2	
	Umbrako Linsehode M10x120	04-036-120	4	
	Umbrako Linsehode M10x20	04-036-020	8	
	Umbrako forsenket hode M10x30	04-037-030	4	
	Umbrako forsenket hode M10x25	04-037-025	4	
	Låsemutter M10	04-040-010	4	
	Skive stor M10	04-055-010	16	

Boltepakker for / Boltpackage for / Bultpaket för		Sign. _____.		
Arm og ryggstøtte 08-001-190K	Navn	Artnr/ dimensjon	Ant	Lev
	Hylse gjenge M10 L=40	04-021-011	4	
	Hylse gjenge M10 L=30	04-021-010	4	
	Plast lokk 40x80	04-090-129	2	
	Plast Lokk 25x50	04-090-131	4	
	Armstøtte	08-001-190	2	
	Armstøtte HPL Grå	08-001-290	2	
	Sikkerhetslette M10 hode	05-301-046	4	
	Sikkerhetslett M10 kropp	05-301-047	4	

Boltepakker for / Boltpackage for / Bultpaket för

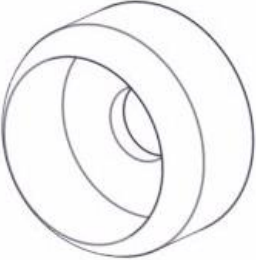
Sign. _____.

Arm og ryggstøtte 08-001-190K	Navn	Artnr/ dimensjon	Ant	Lev
	Endedeksel M10/M12 kropp	05-301-035	4	
	Endedeksel M10/M12 hode	05-301-035	4	

Montering av lekeapparatet / Assembly instructions / Montering av lekredskapet

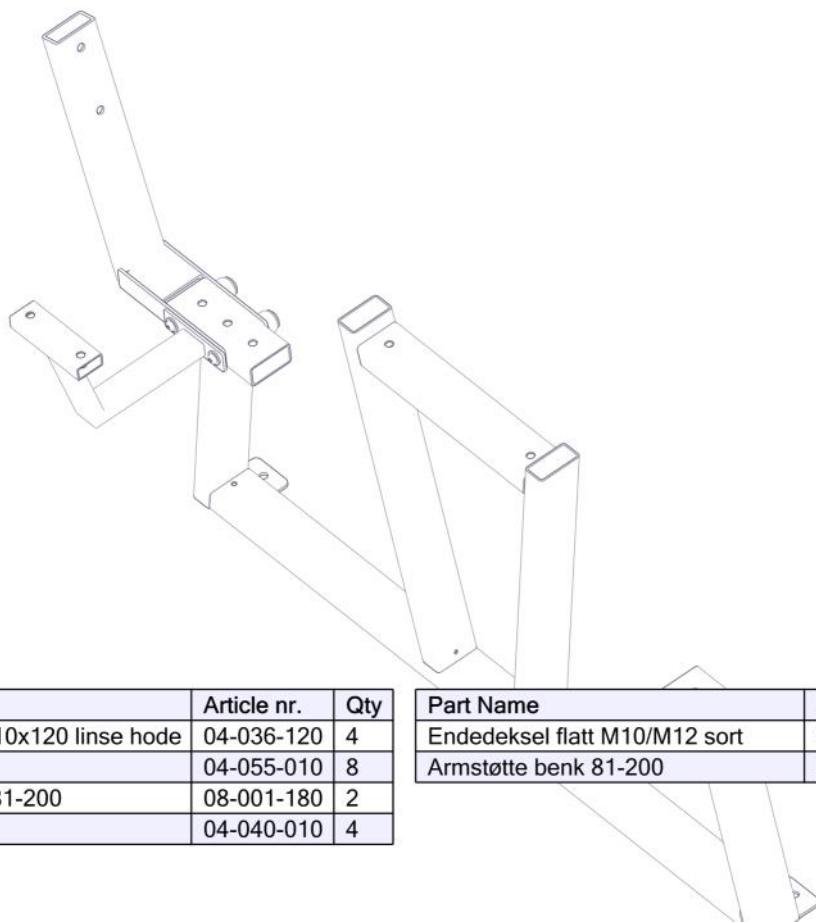

Part Name	Article nr.	Qty
Unbrako skrue M10x120 linse hode	04-036-120	4
Skive M10 stor	04-055-010	8
Ryggstøtte benk 81-200	08-001-180	2
Låsemutter M10	04-040-010	4

Part Name	Article nr.	Qty
Endedeksel flatt M10/M12 sort	05-301-035	8
Armstøtte benk 81-200	07-201-307	2

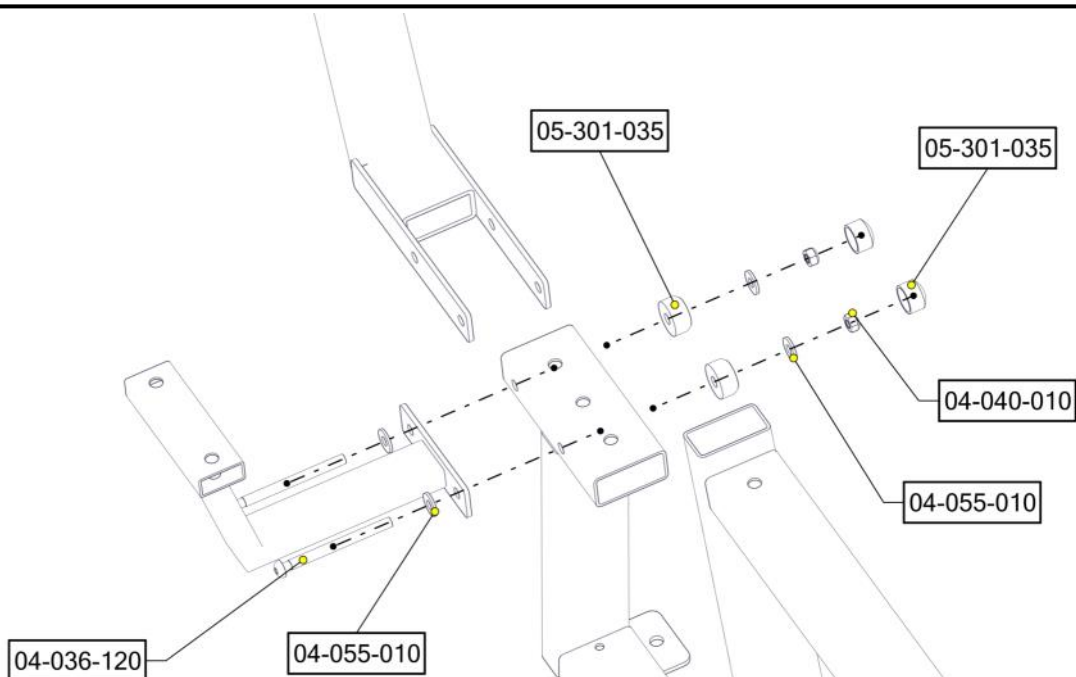

Part Name	Article nr.	Qty
Unbrako skrue M10x120 linse hode	04-036-120	4
Skive M10 stor	04-055-010	8
Ryggstøtte benk 81-200	08-001-180	2
Låsemutter M10	04-040-010	4

Part Name	Article nr.	Qty
Endedeksel flatt M10/M12 sort	05-301-035	8
Armstøtte benk 81-200	07-201-307	2

Montering av lekeapparatet / Assembly instructions / Montering av lekredskapet

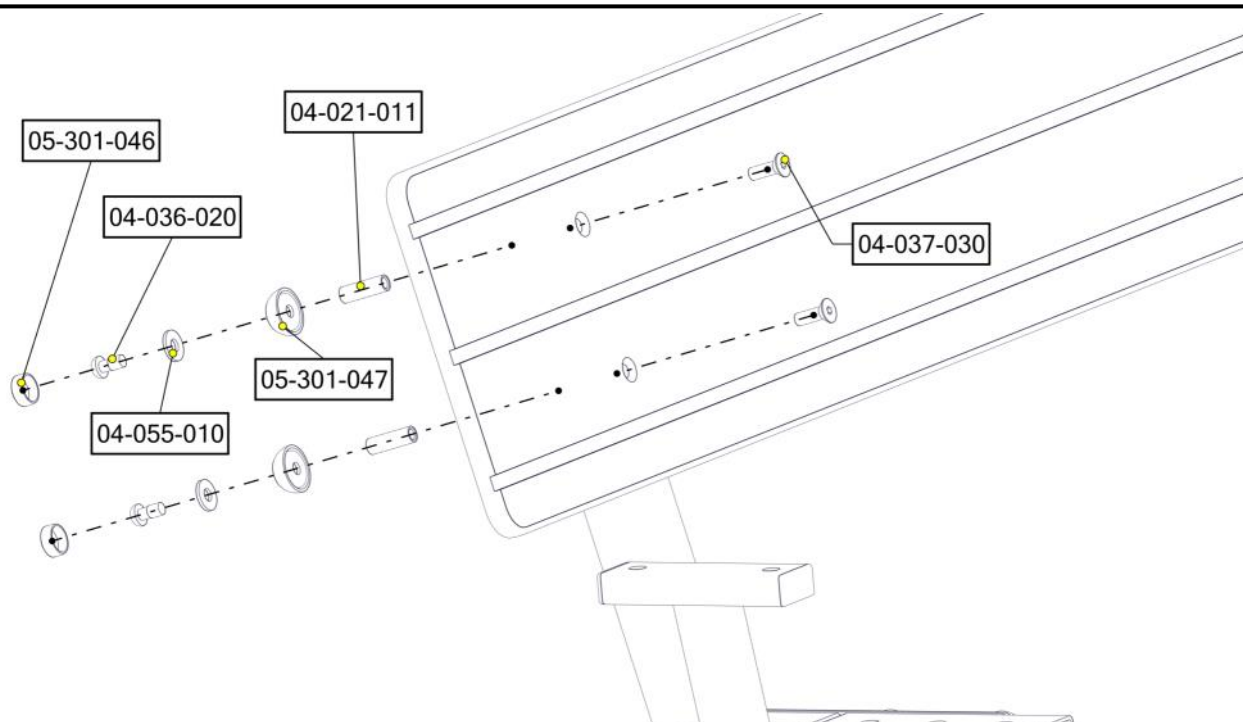
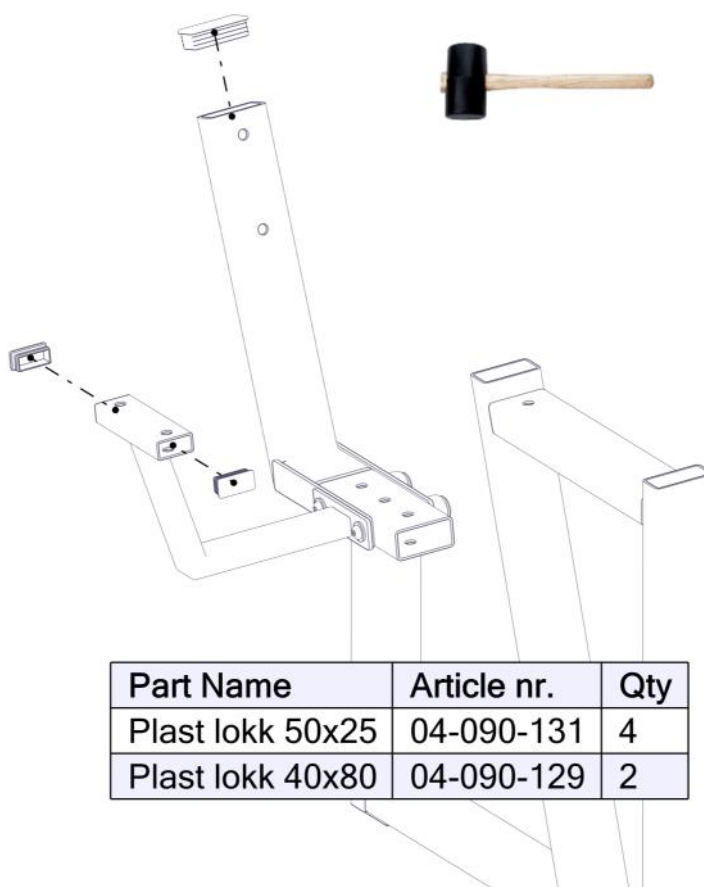

Part Name	Article nr.	Qty
Unbrakoskrue m/nedsenk hode M10x30	04-037-030	4
Unbrako skrue M10x20 linse hode	04-036-020	4
Skive M10 stor	04-055-010	4
Sikkerhetshette kropp 38 svart for M10	05-301-047	4

Part Name	Article nr.	Qty
Sikkerhetshette 25mm svart for M10	05-301-046	4
Hylsegjenge M10 L=40	04-021-011	4
Benkeplate	08-001-230	1

Montering av lekeapparatet / Assembly instructions / Montering av lekredskapet

Se separat delmontering for detaljer
 See separate assembly for details
 Se separata delmontering för detaljer

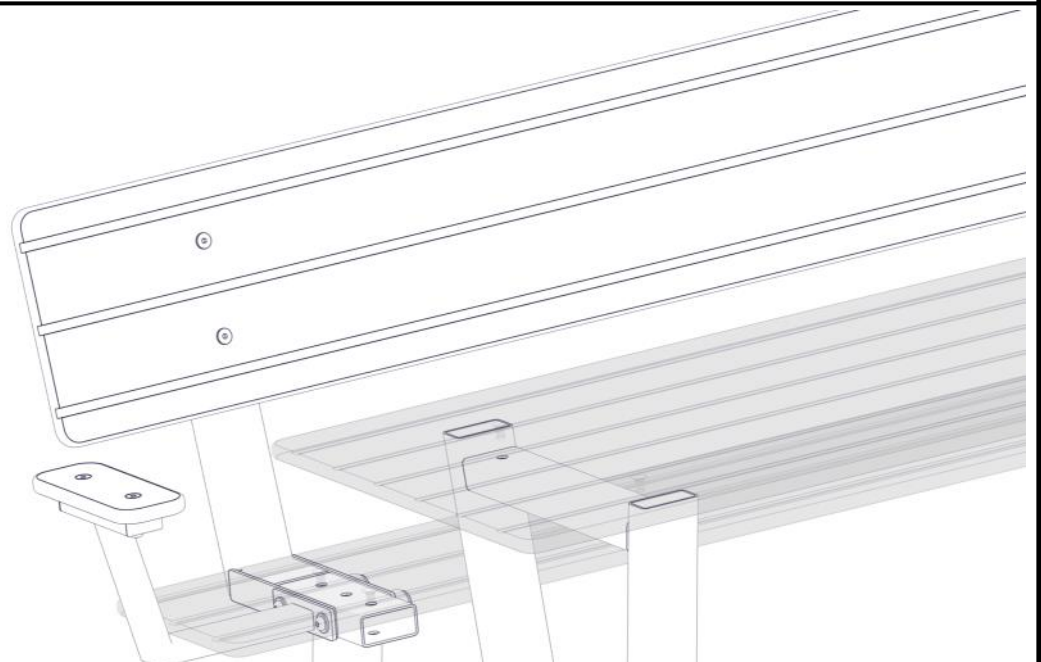
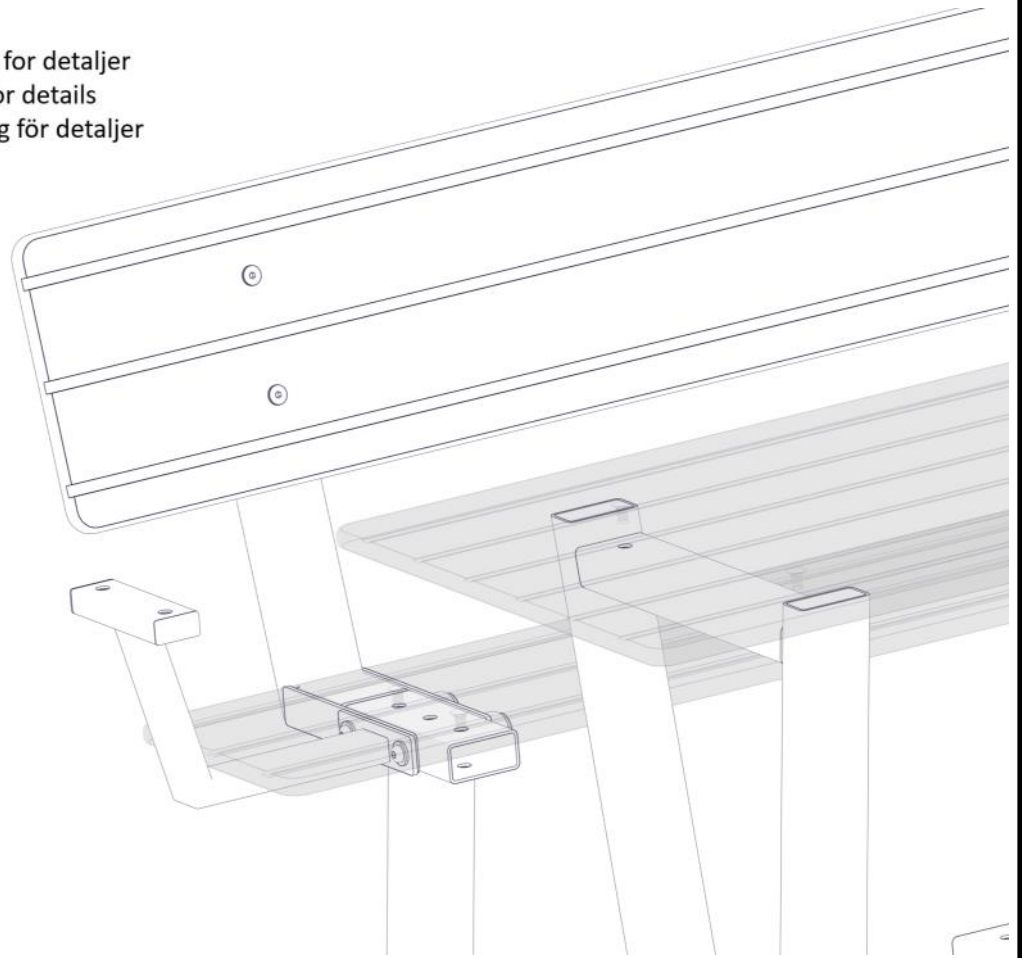





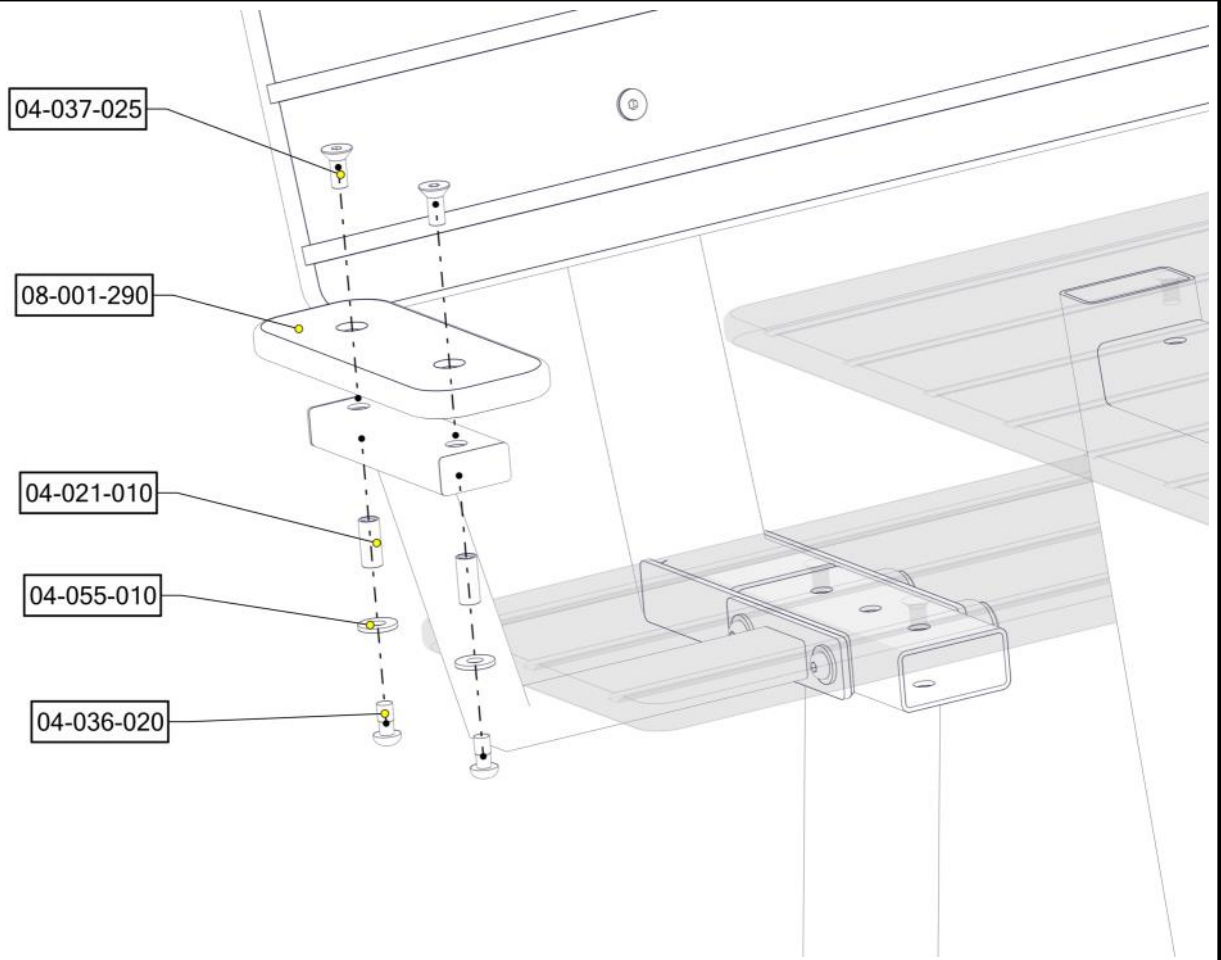

Part Name	Article nr.	Qty
Unbrakoskrue m/nedsenk hode M10x25	04-037-025	4
Unbrako skruer M10x20 linse hode	04-036-020	4
Skive M10 stor	04-055-010	4
Hylsegjenge M10 L=30	04-021-010	4
Armstøtte HPL	08-001-290	2

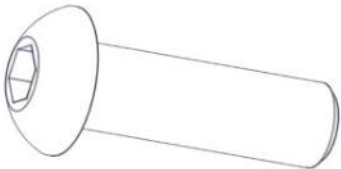
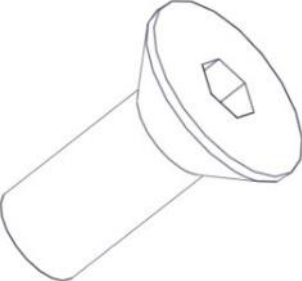

Montering av lekeapparatet / Assembly instructions / Montering av lekredskapet

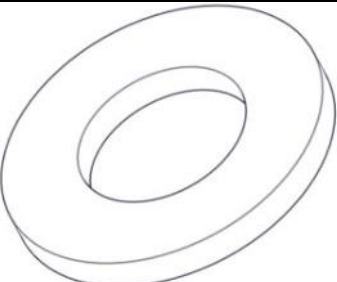

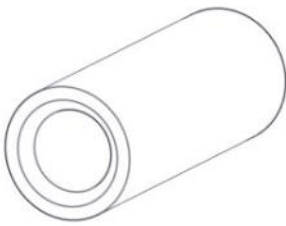

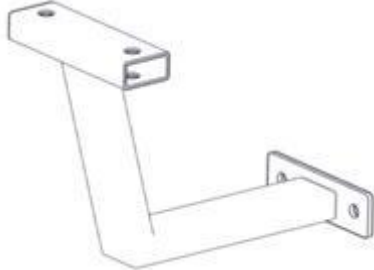
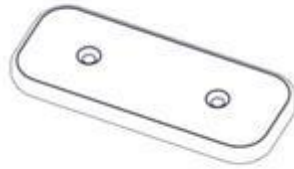
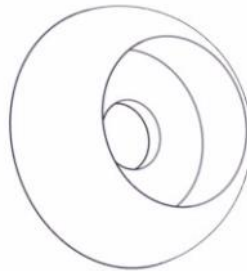
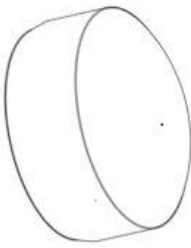
Boltepakker for / Boltpackage for / Bultpaket för		Sign. _____		
Arm og ryggstøtte 08-001-190K	Navn	Artnr/ dimensjon	Ant	Lev
	Benkeplate Grå	08-001-230	1	
	Ryggstøtte benk 81-200 Sort	08-001-180	2	
	Umbrako Linsehode M10x120	04-036-120	4	
	Umbrako Linsehode M10x20	04-036-020	8	
	Umbrako forsenket hode M10x30	04-037-030	4	
	Umbrako forsenket hode M10x25	04-037-025	4	
	Låsemutter M10	04-040-010	4	
	Skive stor M10	04-055-010	16	

Boltepakker for / Boltpackage for / Bultpaket för		Sign. _____.		
Arm og ryggstøtte 08-001-190K	Navn	Artnr/ dimensjon	Ant	Lev
	Hylse gjenge M10 L=40	04-021-011	4	
	Hylse gjenge M10 L=30	04-021-010	4	
	Plast lokk 40x80	04-090-129	2	
	Plast Lokk 25x50	04-090-131	4	
	Armstøtte	08-001-190	2	
	Armstøtte HPL Grå	08-001-290	2	
	Sikkerhetslette M10 hode	05-301-046	4	
	Sikkerhetslett M10 kropp	05-301-047	4	

Boltepakker for / Boltpackage for / Bultpaket för

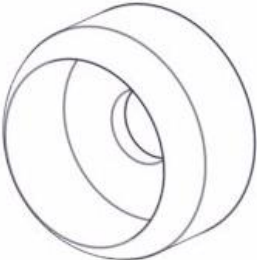
Sign. _____.

Arm og ryggstøtte 08-001-190K	Navn	Artnr/ dimensjon	Ant	Lev
	Endedeksel M10/M12 kropp	05-301-035	4	
	Endedeksel M10/M12 hode	05-301-035	4	