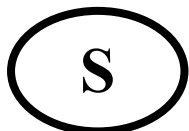

**Monteringsanvisning****Assembly Instructions****Monteringsanvisning**

Produkt nr. / Product no. / Produkt nr.

**08-001-283K**

Sort

Ord. nr. \_\_\_\_\_

Dato. \_\_\_\_\_

Sign. \_\_\_\_\_

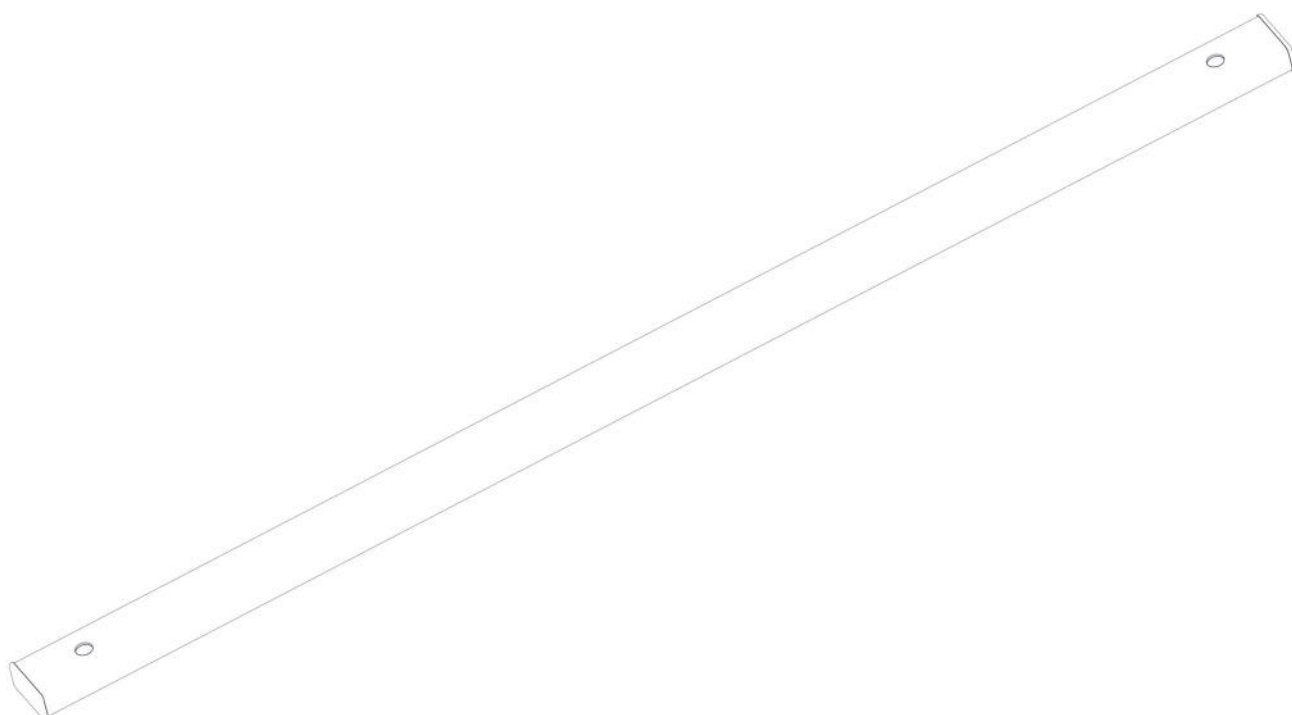
**søve**

Søve AS  
Grønnvoldveien 290  
3830 Ulefoss - Norway  
Tlf: +47 35 94 65 65  
[www.sove.no](http://www.sove.no)

**søve**

Søve AB  
EA Rosengrensgatan 32  
421 31 Västra Frölunda  
Phone: +46 (0)31 773 97 00  
[www.sove.se](http://www.sove.se)

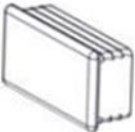

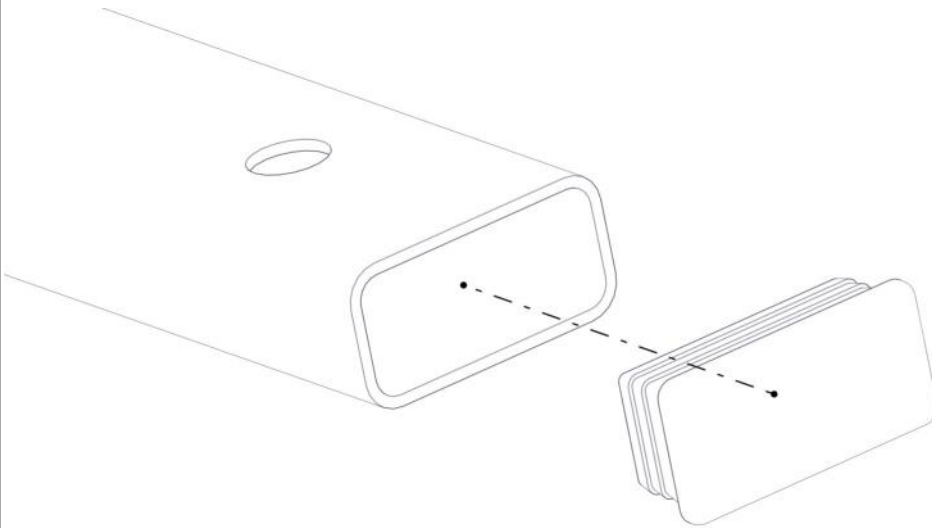
| <b>Boltepakker for / Boltpackage for / Bultpaket för</b>                          |   | Sign. _____.           |            |            |
|---|---|------------------------|------------|------------|
| <b>Parkmøbel- UnderBord-<br/>Frame, low , sort<br/>08-001-283K</b>                | <b>Navn</b>   | <b>Artnr/dimensjon</b> | <b>Ant</b> | <b>Lev</b> |
|  | Parkmøbel-<br>UnderBordFrame<br>LOW<br>Sort<br>L=1100 | 08-001-283             | 1          |            |
|  | Plasthette til 50x25<br>firkantør                     | 04-090-131             | 2          |            |
|   |   |                        |            |            |
|   |   |                        |            |            |
|   |   |                        |            |            |
|   |   |                        |            |            |

**Montering av lekeapparatet / Assembly instructions / Montering av lekredskapet**

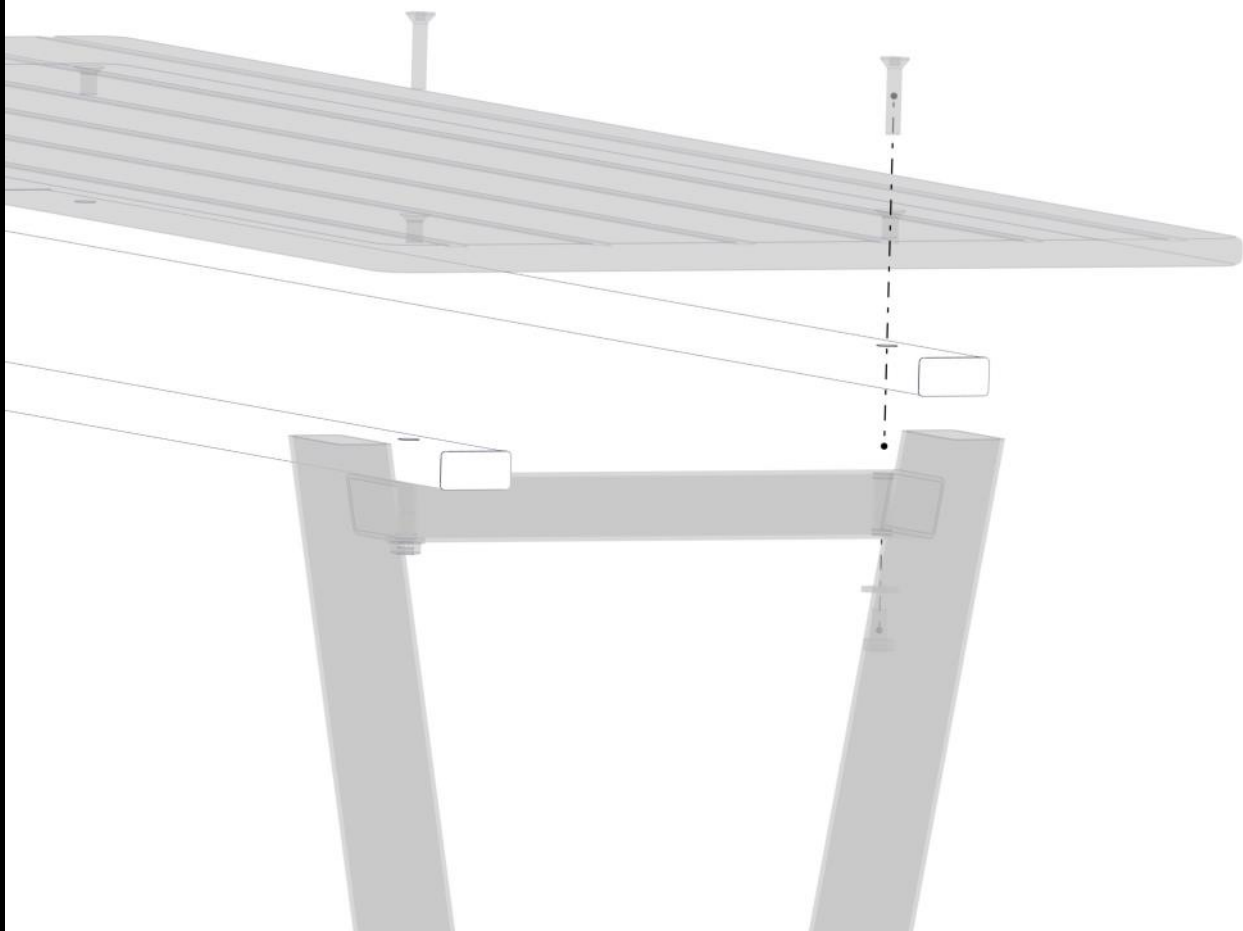
| Part Name          | Article nr. | Qty |
|--------------------|-------------|-----|
| Plast lokk 50x25   | 04-090-131  | 2   |
| UnderBordFrame-Low | 08-001-283  | 1   |





| <b>Boltepakker for / Boltpackage for / Bultpaket för</b>                          |   | Sign. _____.           |            |            |
|---|---|------------------------|------------|------------|
| <b>Parkmøbel- UnderBord-<br/>Frame, Low , sort<br/>08-001-283K</b>                | <b>Navn</b>   | <b>Artnr/dimensjon</b> | <b>Ant</b> | <b>Lev</b> |
|  | Parkmøbel-<br>UnderBordFrame<br>LOW<br>Sort<br>L=1100 | 08-001-283             | 1          |            |
|  | Plasthette til 50x25<br>firkantrør                    | 04-090-131             | 2          |            |
|   |   |                        |            |            |
|   |   |                        |            |            |
|   |   |                        |            |            |
|   |   |                        |            |            |