

N

Monteringsanvisning

EN

Assembly Instructions

S

Monteringsanvisning

Produkt nr. / Product no. / Produkt nr.

08-001-431K**Lysegrønn**

Ord. nr. _____

Dato. _____

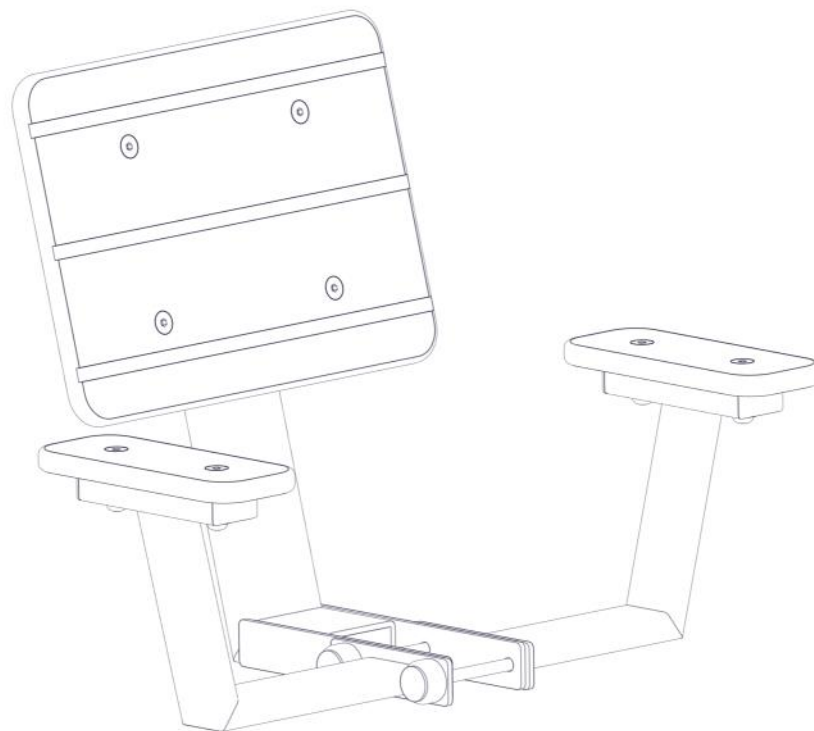

Sign. _____



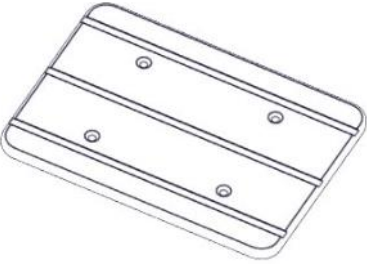
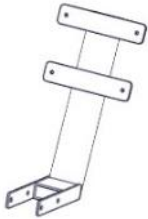
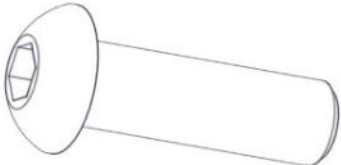
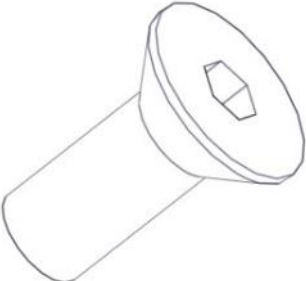

**sove**

Søve AS
Grønnvoldveien 290
3830 Ulefoss - Norway
Tlf: +47 35 94 65 65
www.sove.no

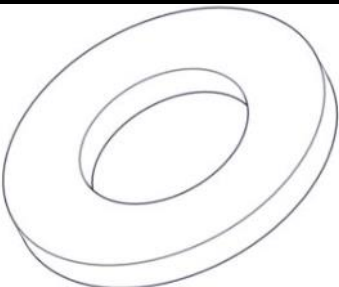
**sove**

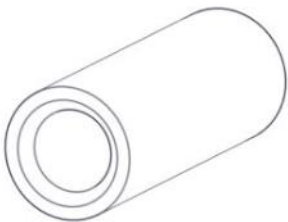

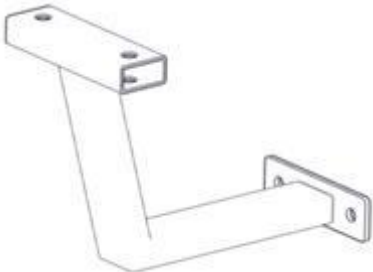
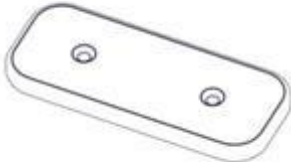
Søve AB
EA Rosengrensgatan 32
421 31 Västra Frölunda
Phone: +46 (0)31 773 97 00
www.sove.se

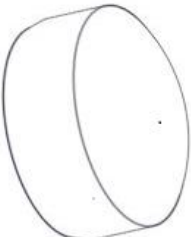
Boltepakker for / Boltpackage for / Bultpaket för		Sign. _____		
Arm og ryggstøtte, stol 08-001-431K, Lysegrønn	Navn	Artnr/ dimensjon	Ant	Lev
	Parkmøbler stol Sete Lysegrønn	08-001-411	1	
	Ryggstøtte stol 81-200 Sort	08-001-404	1	
	Umbrako Linsehode M10x120	04-036-120	2	
	Umbrako Linsehode M10x20	04-037-020	4	
	Umbrako forsenket hode M10x40	04-037-040	4	
	Umbrako forsenket hode M10x25	04-037-025	4	
	Låsemutter M10	04-040-010	6	
	Skive stor M10	04-055-010	6	
	Skive stor M10 polyfix	04-055-036	6	

Boltepakker for / Boltpackage for / Bultpaket för		Sign. _____.		
Arm og ryggstøtte 08-001-431K, Lysegrønn	Navn	Artnr/ dimensjon	Ant	Lev
	Hylse gjenge M10 L=30	04-021-010	4	
	Plast lokk 40x80	04-090-129	1	
	Plast Lokk 25x50	04-090-131	4	
	Armstøtte	08-001-190	2	
	Armstøtte HPL Lysegrønn	08-001-291	2	
	Sikkerhetslette M10 kropp	05-301-046	4	
	Sikkerhetslette M10	05-301-047	4	

Boltepakker for / Boltpackage for / Bultpaket för

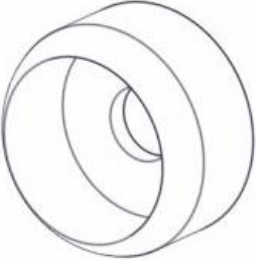
Sign. _____.

Arm og ryggstøtte 08-001-430K	Navn	Artnr/ dimensjon	Ant	Lev
	Endedeksel M10/M12	05-301-035	2	
	Endedeksel M10/M12	05-301-035	2	

Montering av lekeapparatet / Assembly instructions / Montering av lekredskapet

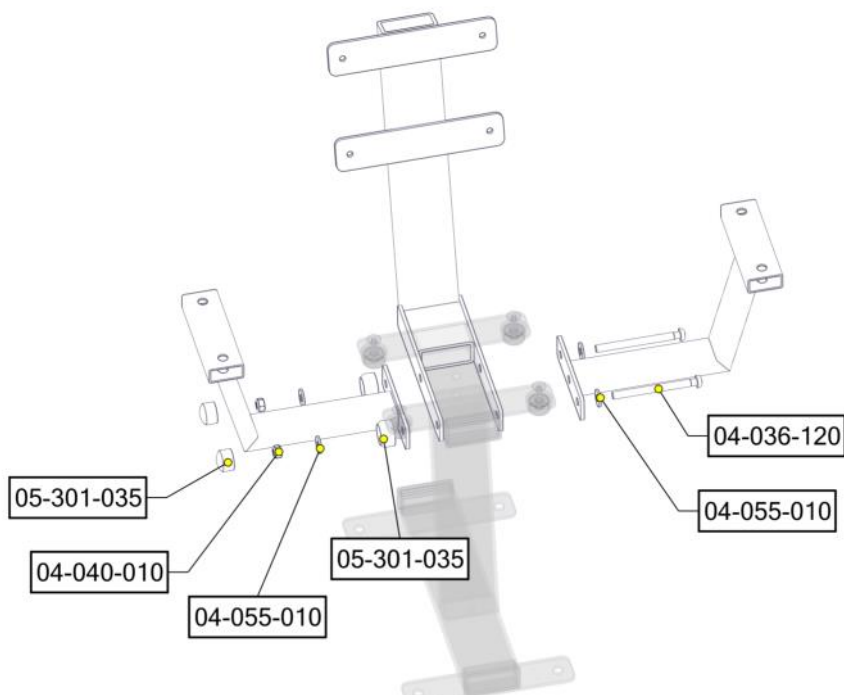

PartName	Artnr	Antall	PartName	Artnr	Antall
Unbrako skrue M10x120 linse hode	04-036-120	2	Endedeksel flatt M10/M12 sort hode	05-301-035	2
Låsemutter M10	04-040-010	2	Armstøtte benk 81-200	07-201-307	2
Skive M10 stor	04-055-010	4	Ryggstøtte Stol 81-200	07-201-404	1
Endedeksel flatt M10/M12 sort kropp	05-301-035	2			

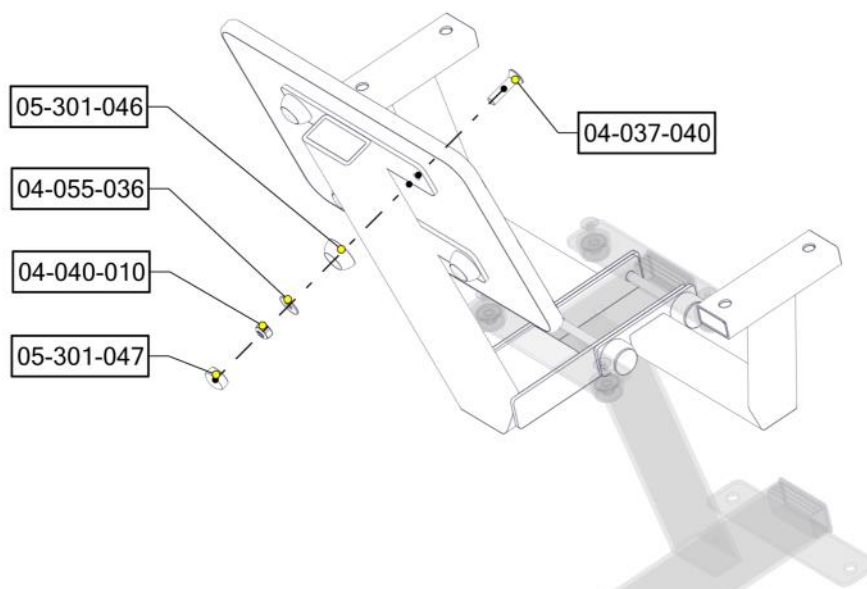

PartName	Artnr	Antall
Unbrakoskrue m/nedsenk hode M10x40	04-037-040	4
Låsemutter M10	04-040-010	4
Skive M8 stor	04-055-036	4
Sikkerhetshette kropp 38 svart for M10	05-301-046	4
Sikkerhetshette 25mm svart for M10	05-301-047	4
Parkmøbler, stol sete	08-001-411	1

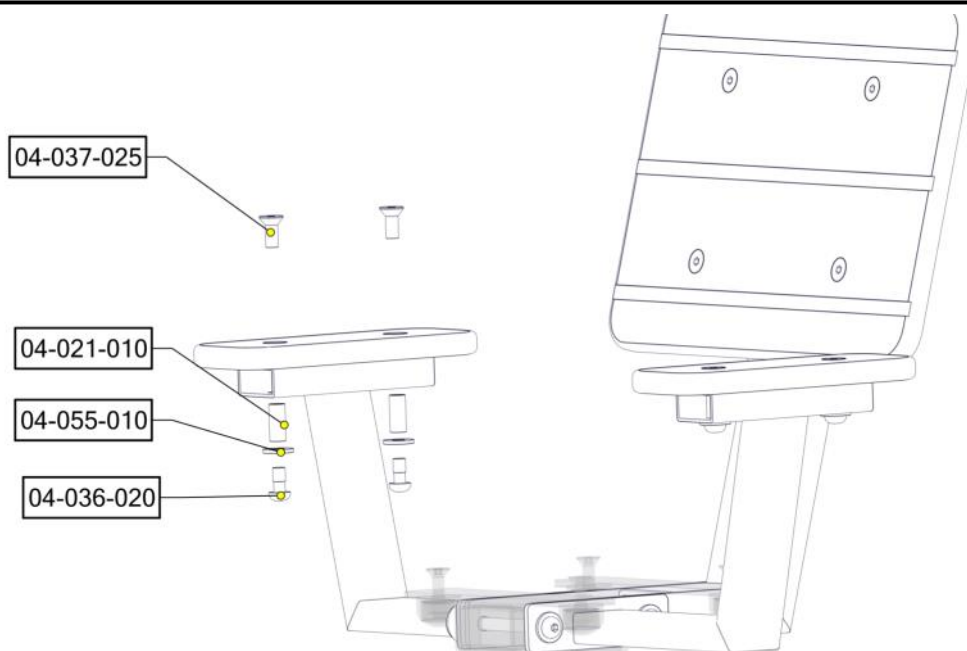

Montering av lekeapparatet / Assembly instructions / Montering av lekredskapet



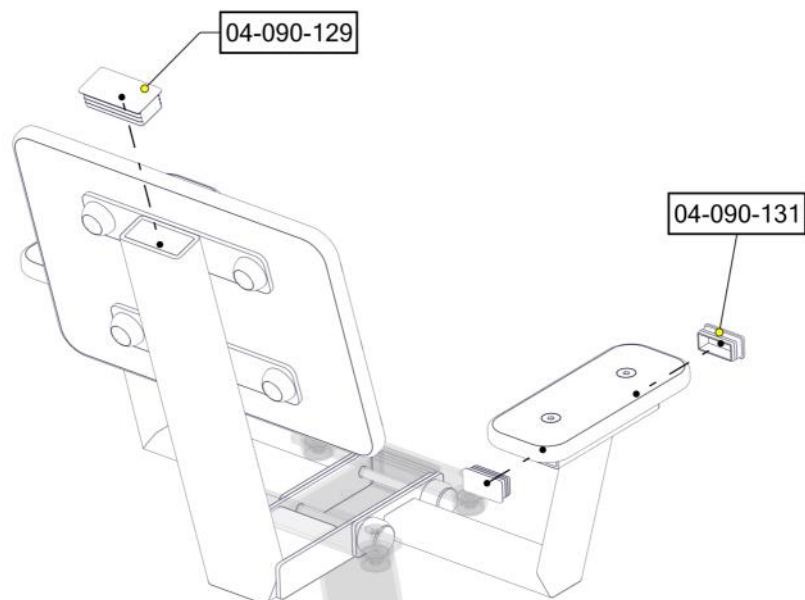

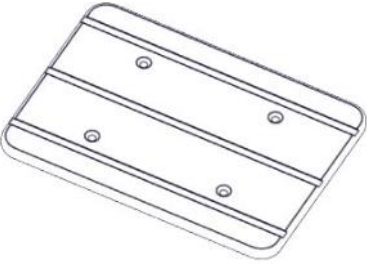
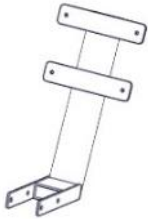
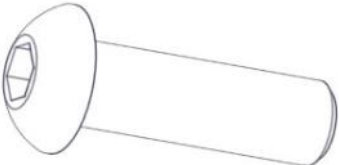
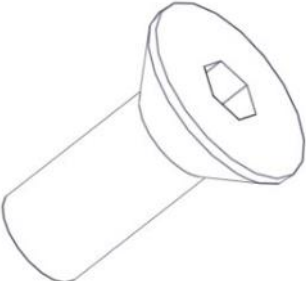

PartName	Artnr	Antall
Hylsegjenge M10 L=30	04-021-010	4
Unbrako skrue M10x20 linse hode	04-036-020	4
Unbrakoskrue m/nedsenk hode M10x25	04-037-025	4
Skive M10 stor	04-055-010	4
Armstøtte HPL	08-001-291	2

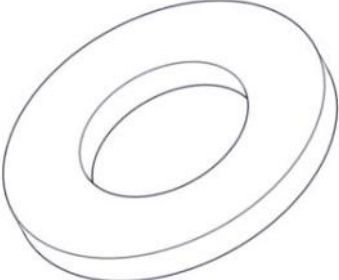

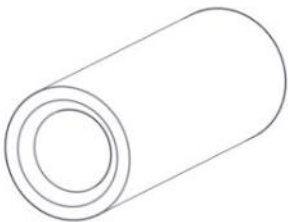

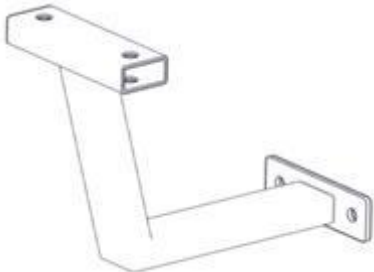
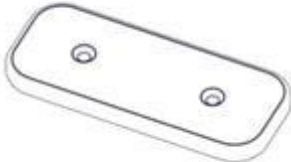
PartName	Artnr	Antall
Plast lokk 40x80	04-090-129	1
Plast lokk 50x25	04-090-131	4

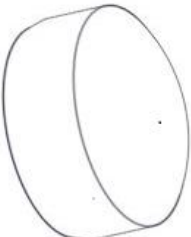
Boltepakker for / Boltpackage for / Bultpaket för		Sign. _____		
Arm og ryggstøtte, stol 08-001-431K, Lysegrønn	Navn	Artnr/ dimensjon	Ant	Lev
	Parkmøbler stol Sete Lysegrønn	08-001-411	1	
	Ryggstøtte stol 81-200 Sort	08-001-404	1	
	Umbrako Linsehode M10x120	04-036-120	2	
	Umbrako Linsehode M10x20	04-037-020	4	
	Umbrako forsenket hode M10x40	04-037-040	4	
	Umbrako forsenket hode M10x25	04-037-025	4	
	Låsemutter M10	04-040-010	6	
	Skive stor M10	04-055-010	6	
	Skive stor M10 polyfix	04-055-036	6	

Boltepakker for / Boltpackage for / Bultpaket för		Sign. _____.		
Arm og ryggstøtte 08-001-431K, Lysegrønn	Navn	Artnr/ dimensjon	Ant	Lev
	Hylse gjenge M10 L=30	04-021-010	4	
	Plast lokk 40x80	04-090-129	1	
	Plast Lokk 25x50	04-090-131	4	
	Armstøtte	08-001-190	2	
	Armstøtte HPL Lysegrønn	08-001-291	2	
	Sikkerhetslette M10 kropp	05-301-046	4	
	Sikkerhetslette M10	05-301-047	4	

Boltepakker for / Boltpackage for / Bultpaket för

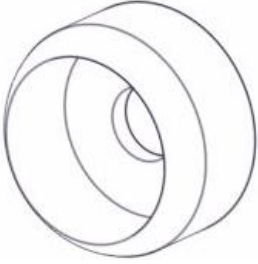
Sign. _____.

Arm og ryggstøtte 08-001-430K	Navn	Artnr/ dimensjon	Ant	Lev
	Endedeksel M10/M12	05-301-035	2	
	Endedeksel M10/M12	05-301-035	2	