

N**Monteringsanvisning****EN****Assembly Instructions****S****Monteringsanvisning**

Produkt nr. / Product no. / Produkt nr.

11-145-150

Ordr. nr. _____

Dato. _____

Sign. _____

**søve**

Søve AS
Grønnvoldveien 290
3830 Ulefoss - Norway
Tlf: +47 35 94 65 65

**søve**

Søve AB
EA Rosengrensgatan 32
421 31 Västra Frölunda
Phone: +46 (0)31 773 97 00
www.sove.se

Monteringstips / Assembly Advice / Monteringsstips

N

- Les monteringsanvisningen nøye før montering.
- Monter elementene i rekkefølgen som vist.
- Boltene bør ikke skrues for hardt til før alt er montert, vatret og loddet. Skru så boltene til.
- NB! Ved bruk av drill, kan boltene ryke.
- På grunn av at solen kan gjøre rutsjeplatene veldig varme, bør rutsjebanens utløp vende mot nord-øst eller nord-vest.
- Er lekeutstyret plassert i naturlige ferdselstraséer må området sikres mot gjennomgang.
- Innspringningshinder bør vurderes rundt lekeapparater hvor det er stor bevegelse, f.eks. ved huskestativ.
- Det bør være fritt innsyn til lekeutstyr som er beregnet for barn under 3 år.

NB! Under monteringsarbeidet må utstyr, som ikke er forankret forsvarlig i bakken, sikres slik at det ikke velte.

Området må avstenges under montering av apparatene med sperrebånd eller lignende.

EN

- Read the instruction carefully before assembling the play unit..
- Assemble the components in the sequence shown in these instructions.
- Fixings must not be fully tightened during assembly. Before casting the foundations, the structure must be level and plumb, at which point all fixings are tightened.
- PS! If use of drill, the bolts may be wrecked.
- Avoid positioning the slide facing due south because of overheating – ideal positions are facing north-east or north-west.
- Secure the construction-area to prevent people from walking through it.
- Consider installing barriers around play-equipment which gives rise to a lot of activity – i.e.swings.
- Ensure that clear vision is possible across the play area so that supervision is possible from any position, particularly where children under 3 years of age will be playing.

NB! During assembly of the equipment, ensure that all structures are securely propped, especially when left overnight. Also ensure that equipment is supported whilst concrete foundations are setting and enclose the area securely to prevent access.

Monteringstips / Assembly Advice / Monteringsstips











S

- Läs monteringsanvisningen noga före montering.
 - Montera delarna i den ordningen som anvisas
 - Skruvarna bör inte skruvas för hårt tills allt är monterat, i våg och lodat.
- OBS! Används elektrisk skruvdragare, kan bulten gå sönder. Härddra därför manuellt!
- Solen kan göra att rutchbanan blir väldigt varm. Banans nedfart rekommenderas att vändas i norrlig riktning
 - Om lekplatsen placeras vid en gångväg mm bör området säkras mot genomfart av gående och cyklister.
 - Insprängningshinder bör placeras runt lekutrustning med stor rörelse, t ex, gungställning.
 - Det bör vara fri insyn till lekutrustning beräknat till barn under 3 år.

OBS! Under monteringsarbete bör utrustningen som inte ska förankras i marken, ställs så att den inte kan välta.

Området måste spärras när lekutrustningen byggs upp, med avspärrningsband eller liknande.

Nødvendig verktøy / Tools required / Nödvändiga verktyg

<p>(N)</p> <p>(EN)</p> <p>(S)</p>	<p>(A)</p> 	<p>(B)</p>  <p>Torx Nr 45 High quality</p>	<p>(C)</p> <p>5 mm 6 mm</p> 	<p>(D)</p> 	<p>(E)</p> 
		<p>Metermål Metric measure Tumstock</p> 	<p>16 V</p> 	<p>Merkebånd Mark ribbon Märkeband</p> 	<p>13 + 17mm</p> 

Nødvendig antall personer / Number of persons required / Rekommenderad antal personer





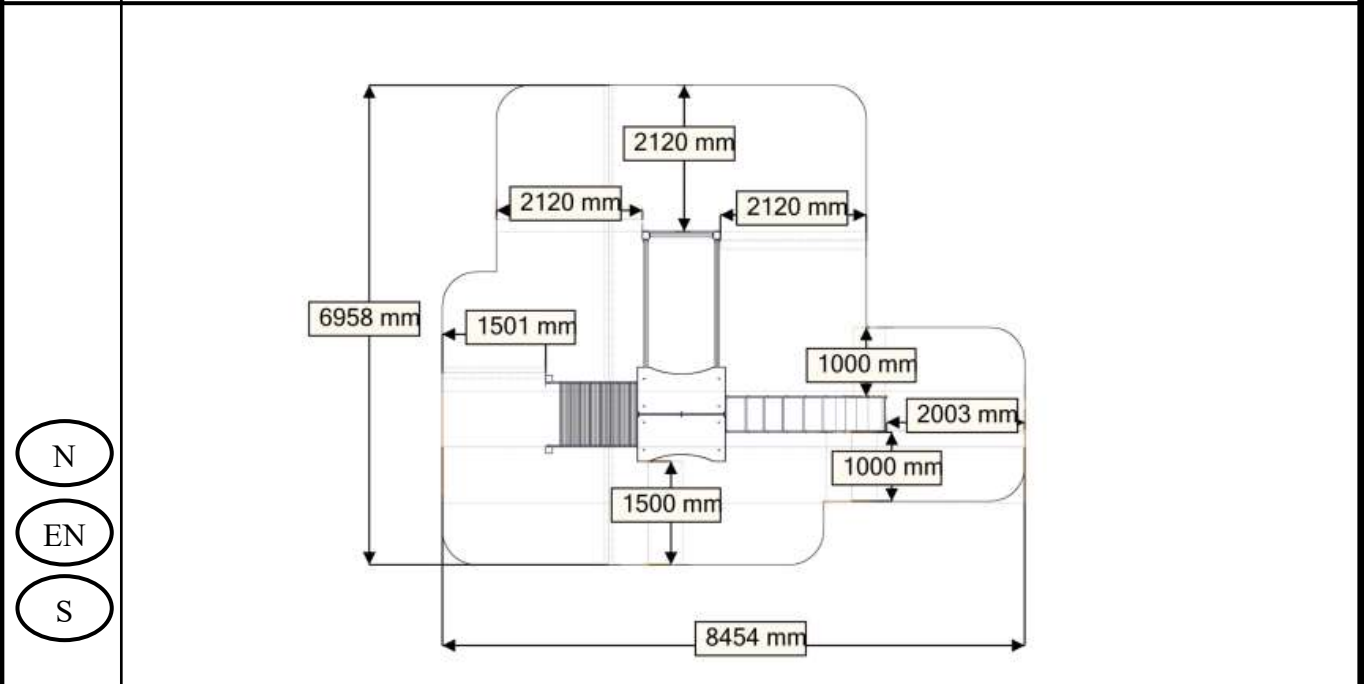











Anbefalt arealbehov ved montering / Recommended working space / Rekommenderad arealbehov vid montering











Boltepakker for / Boltpackage for / Bultpaket för

Sign. _____

Stolpe 95x95	Ant= 1	Artikkel	Artikkelnr.	Ant	Lev
		VK95 L=3235 600-2635 (4)	00-400-009	4	
		Endelokk (1)	00-400-998	4	
Portal 01-400-220	Ant= 1	Artikkel	Artikkelnr.	Ant	Lev
		Frontplate (2)	01-126-003	2	
		Side plate H (1) Side plate V (1)	01-126-001 01-126-002	1 1	
		Sperrerør (1)	01-126-004	1	
		Stolpe VK95 (2) L=640	01-126-005	2	
		Stolpende (2)	00-400-998	2	
		Torx M8x12(2) Torx M8x16 (6) Torx M8x35 (16) Torx M8x45 (2)	04-000-012 04-000-016 04-000-035 04-000-045	2 6 16 2	
		Brikke 120 3T (8)	04-060-120	8	
		Vinkel (2) 35x35x3 11mm hull	04-070-036	2	
		Møbelknapp (6) M8-13-17	04-030-011	8	
		Hylesmutter (2) M8 12-38	04-018-060	2	
		Skive M8 (4)	04-050-008	4	
		Plast plug 9-11 mm (4)	04-090-002	4	

















Boltepakker for / Boltpackage for / Bultpaket för

Sign. _____.

Trapp 1400 01-129-084	Ant= 1	Artikkel	Artikkelnr.	Ant	Lev
		Trapp 1400	01-129-084	1	
		Trapp vange (2) 2152x195x15	01-129-004	2	
		Trapp vange (2) 2152x145x15	01-129-005	2	
		Stolpe 95x95 (2) L=1300	01-129-006	2	
		Torx M8x35 (24)	04-000-035	24	
		Brikke 120_3T (12)	04-060-120	12	
		Endelokk (2)	00-400-998	2	
Produktmerke	Ant= 1	Navn	Artnr/dimensjon	Ant	Lev
		Produktmerking Hos Søve	25-200-090	1	











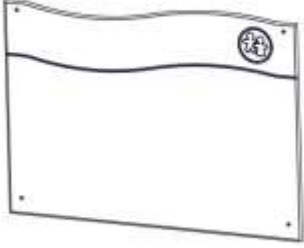
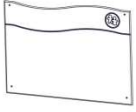

Boltepakker for / Boltpackage for / Bultpaket för

Sign. _____

Sprosse 01-400-108	Ant= 4	Artikkel	Artikkelnr.	Ant	Lev
		Sprosse (1) 1160x145x15	01-400-108	4	
		Torx M8x35 (4)	04-000-035	16	
		Brikke 150_3T (2) På stolpe	04-060-150	0	
Sprosse ribbevegg	Ant= 1	Navn	Artnr/dimensjon	Ant	Lev
		Sprosse (1) 1160x145x15	01-400-102	1	
		Torx M8x35 (4)	04-000-035	4	
		Brikke 150_3T (2) På stolpe	04-000-150	0	
Ribbevegg	Ant= 1	Navn	Artnr/dimensjon	Ant	Lev
		Stolpe med HPL 600-2435 = 3035	00-400-016	1	
		Stolpe med HPL 600-2435 = 3035	00-400-017	1	
		Torx M8x25 (4)	04-000-025	4	
		Brikke 120_3T (2)	04-060-120	2	
		Sperrerør med beslag L=940	00-400-150	1	
		Ribbevegg rør L=940	00-400-149	5	
		Stolp ende (1)	00-400-998	2	













Boltepakker for / Boltpackage for / Bultpaket för

Sign. _____

Vegg 940x686x12 01-125-002	Ant= 4	Artikkel	Artikkelnr.	Ant	Lev
		Vegg 940x686x12 (1)	01-125-002	4	
		Brikke 50_1T(4)	04-060-050	16	
		Torx M8x25(8)	04-000-025	32	
		Vinkel 50x50x50x4 (4)	04-075-050	16	
		Låsemutter M8(4)	04-040-008	16	
Tak 01-128-000	Ant= 1	Artikkel	Artikkelnr.	Ant	Lev
		Tak 1280x960x12 (2)	01-128-001	2	
		Gavel 1216x668x12 (2)	01-128-002	2	
		Brikke 50_1T (4)	04-060-050	4	
		Torx M8x12(22) Torx M8x35(4)	04-000-012 04-000-035	22 4	
		Vinkel 35x35x35x3 (11)	04-070-036	11	
		Møbelknapp M8_13_17(22)	04-030-011	22	
	Skive M8 822)	04-050-008	22		

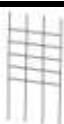











Boltepakker for / Boltpackage for / Bultpaket för

Sign. _____

Ligger N-nett	Ant= 1	Artikkel	Artikkelnr.	Ant	Lev
		Ligger N-nett 4 hull (1) L=1980	00-400-801	1	
		Torx M8x25 (4)	04-000-025	4	
		Brikke 160-2T	04-060-160 1 montert på stolpe	1	
Ligger 00-400-799	Ant= 1	Artikkel	Artikkelnr.	Ant	Lev
		Ligger (1) L=1980	00-400-799	1	
		Torx M8x25 (4)	04-000-025	4	
		Brikke 160-2T (2)	04-060-160 1 montert på stolpe	1	
N-nett 05-156-003	Ant= 1	Navn	Artnr/dimensjon	Ant	Lev
		N- nett (1)	05-156-003	1	
		Torx M8x25(4)	04-000-025	4	
		Fundamentskive(4) 2H 80	00-003-106	4	
		Skive M8(8)	04-050-008	8	
		Låsemutter M8(8)	04-040-008	8	







Boltepakker for / Boltpackage for / Bultpaket för

Sign. _____

Rutsjebane 1400 40-142-101	Ant= 1	Artikkel	Artikkelnr.	Ant	Lev
		Systembane 1400	40-142-101	1	
		Brikke160 3T(2)	04-060-160	2	
		Torx M8x35(8)	04-000-035	8	
		Torx M8x45(2)	04-000-045	2	
		Fundamentskive(2) 2H 80	00-003-106	2	
		Skive M8(2)	04-050-008	6	
		Låsemutter M8(2)	04-040-008	6	
		Stålforankering(2)	00-100-312	2	
	Plast plug 9-11 mm (4)	04-090-002	4		
Gulv 1160x1160x15	Ant= 1	Artikkel	Artikkelnr.	Ant	Lev
		Gulv (1)	00-400-300	1	
		Plast plug 9-11 mm (16)	04-090-002	16	
		Plug spor (8)	00-400-980	8	



Boltepakker for / Boltpackage for / Bultpaket för

Sign. _____.

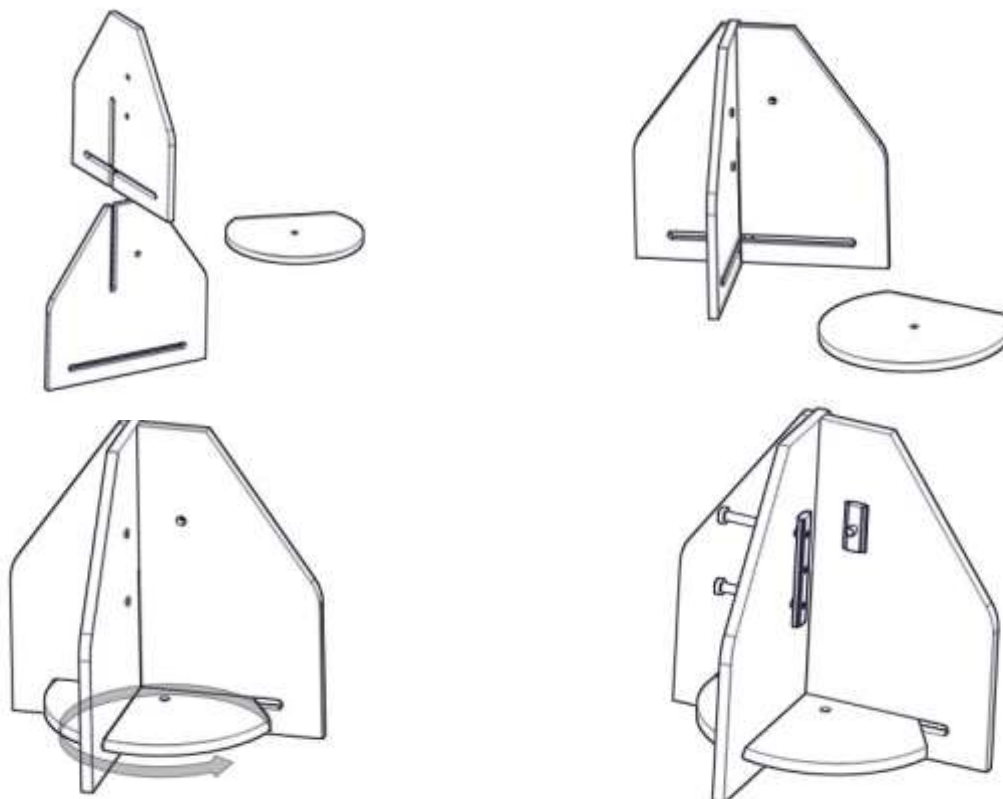

Fundament	Ant= 8	Artikkel	Artikkelnr.	Ant	Lev
		Fundament plate(1)	00-003-100	8	
		Fundamentdel1 (1)	00-003-101	8	
		Fundament del2 (1)	00-003-102	8	
		Torx M8x35(3)	04-000-035	24	
		Brikke 120 3T (1) Brikke 501T(1)	04-060-120 04-060-050	8 8	
		Skive M8 Stor(3)	04-055-008	24	



Fundamentering med betong / Foundation concrete / Förankring med betong

(N)	Støtsand		(N)	(UK)	(S)
(EN)	Safer surface		Bakkenivå	Ground level	Marknivå
(S)	Stridsan		 Ref NS-EN 177		
(N)	Komprimert masse.	betong			
(EN)	Compressed mass.	concrete			
(S)	Komprimerad massa.	betong			

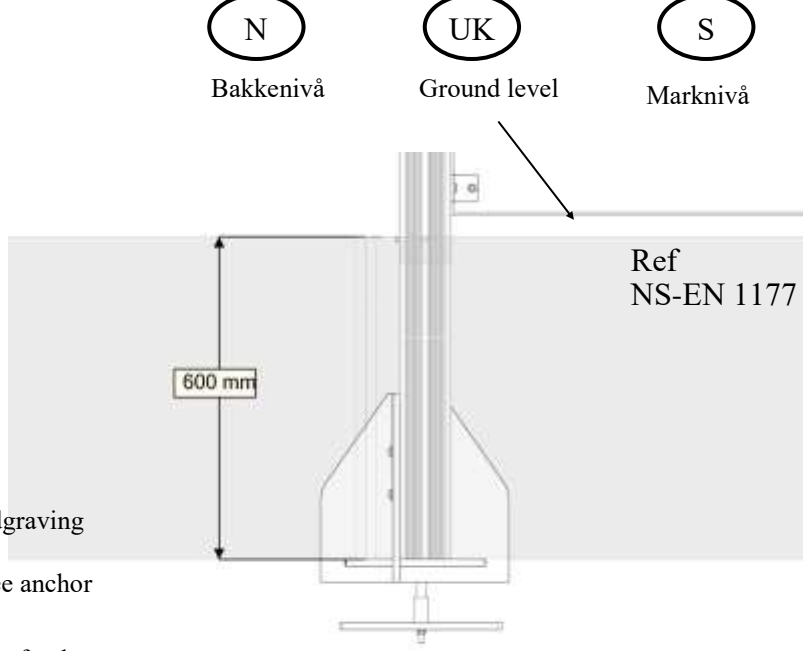
Fundamentering uten betong / Foundation without concrete / Förankring utan betong

(N)	Støtsand		(N)	(UK)	(S)
(EN)	Safer surface		Bakkenivå	Ground level	Marknivå
(S)	Stridsan		 Ref NS-EN 1177		
(N)	Komprimert masse	Støpefri nedgraving			
(EN)	Compressed mass	Concrete-free anchor			
(S)	Komprimerad massa	Nedgrävningfundament			

(N)	Alle mål er oppgitt i millimeter
(EN)	Scale measured in mm
(S)	Alla mått är i millimeter.

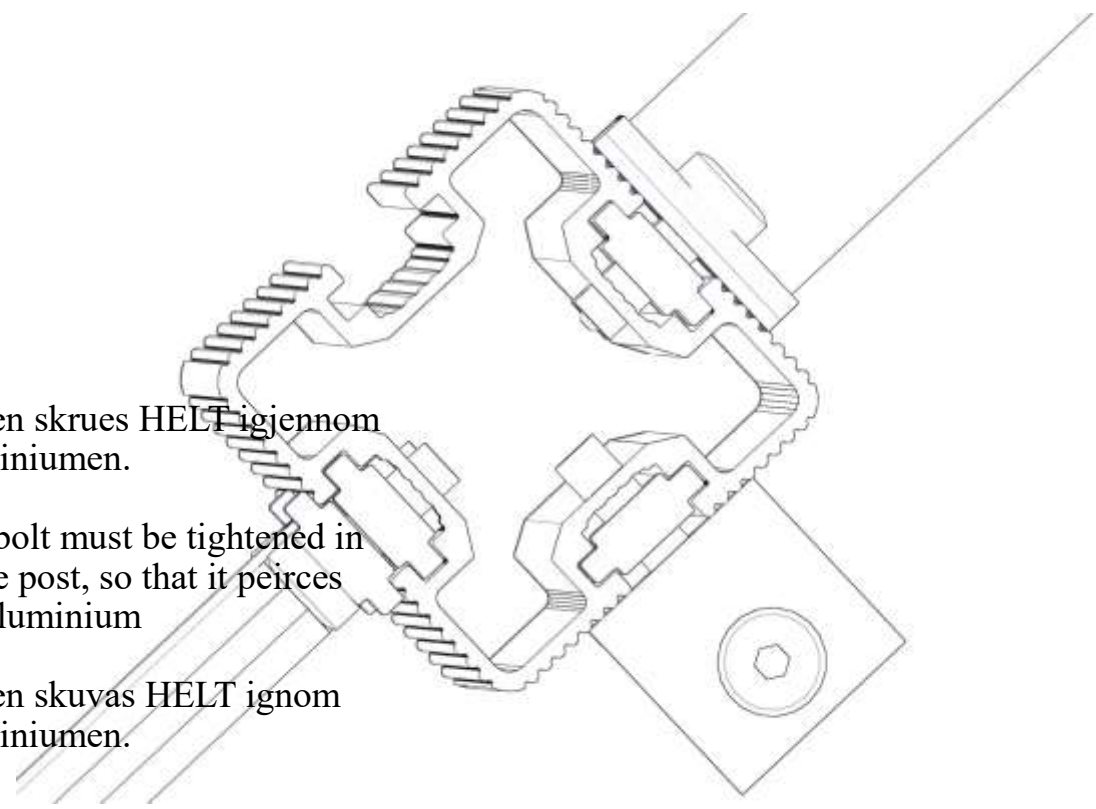
<p data-bbox="124 1556 220 1624">N</p> <p data-bbox="124 1691 220 1758">EN</p> <p data-bbox="124 1848 220 1915">S</p>	 <p data-bbox="239 1579 702 1668">Bolten skrues HELT igjennom aluminiumen.</p> <p data-bbox="239 1691 686 1825">The bolt must be tightened in to the post, so that it peirces the aluminium</p> <p data-bbox="239 1848 662 1937">Bulten skuyas HELT ignom aluminiumen.</p>

Fallhøyder / Free height of fall / Fallhöjder

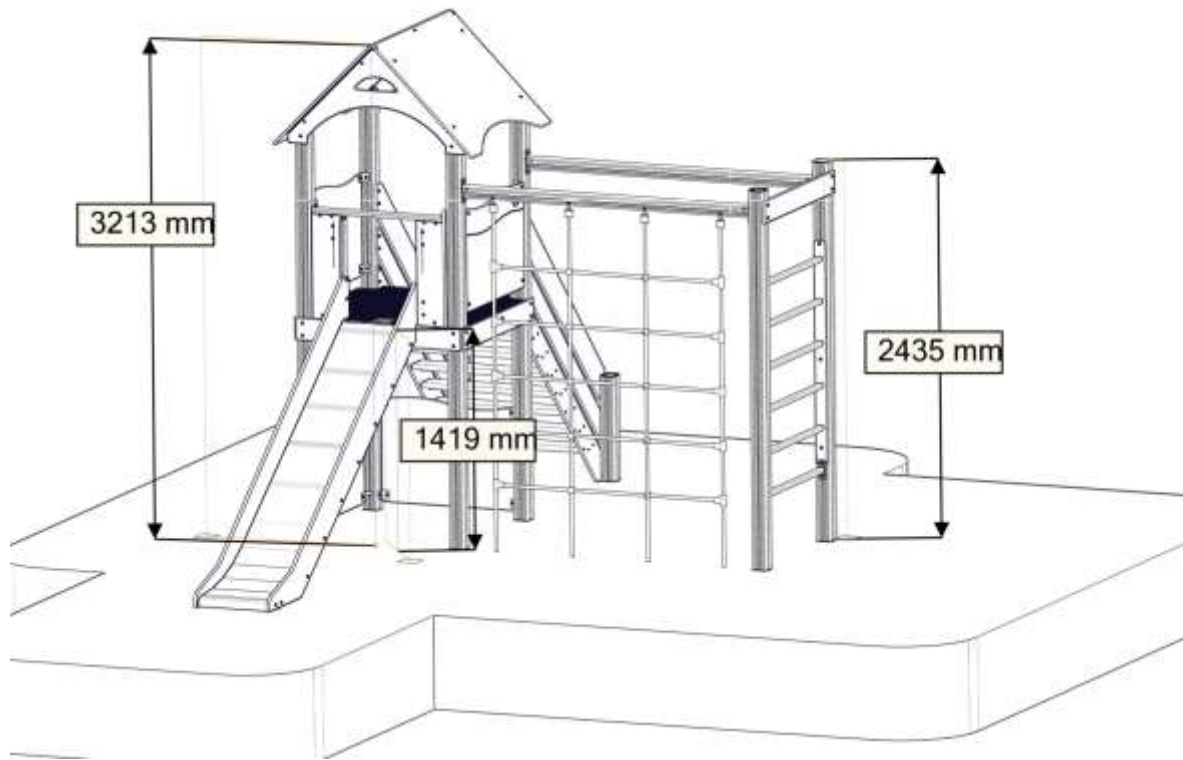

Sikkerhetszone / Safety zone / Säkerhetszon

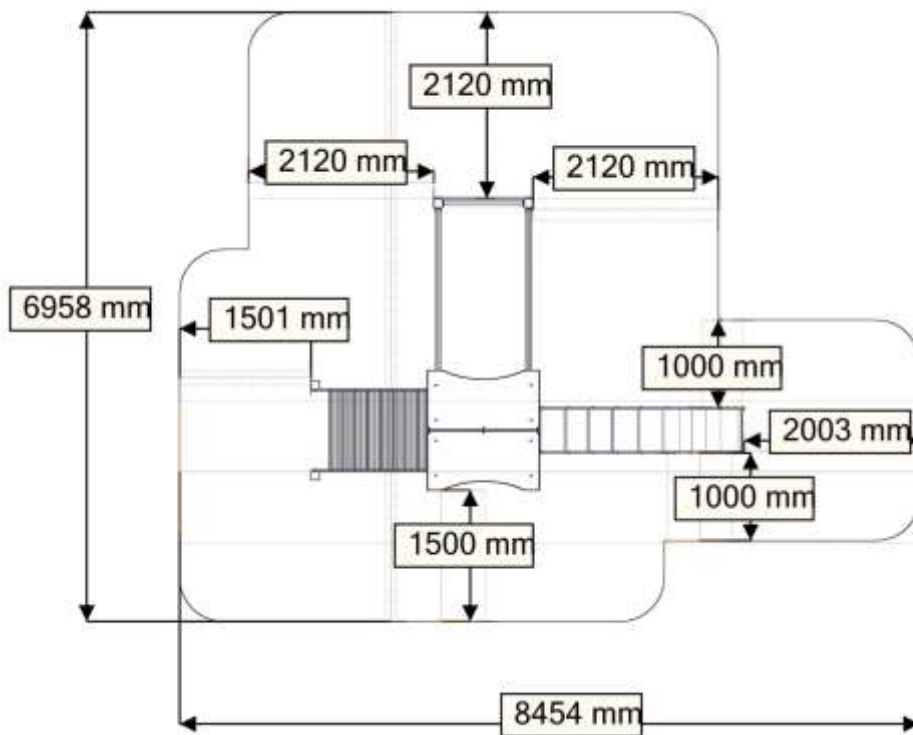

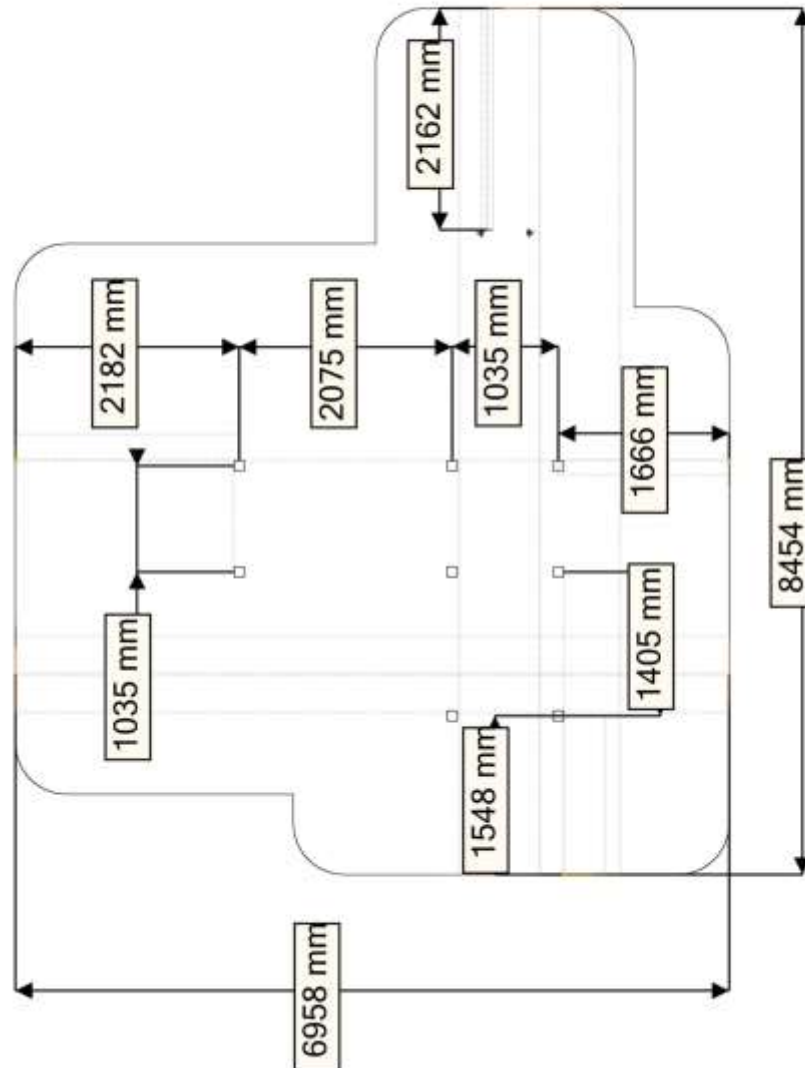
Plassering av forankringer / Ground plan / Placering av förankringar

N

Alle mål er oppgitt i millimeter

UK

Scale measured in mm

S

Alla mått är i millimeter.

Montering av lekeapparatet / Assembly instructions / Montering av lekredskapet

4x

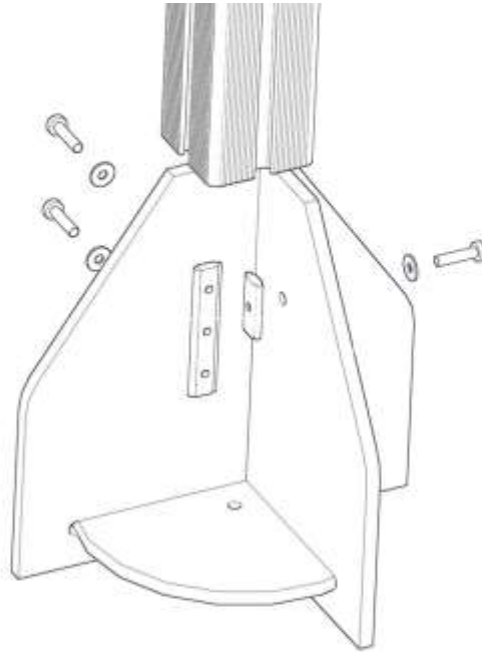

Name	SW Configuration	Artnr (config)	Qty
brikke_SFA5116-1	120_3T	04-060-120	1
brikke_SFA5116-2	50_1T	04-060-050	1
Fun_VK95_a-1	Default	00-003-101	1
Fun_VK95_b-1	Default	00-003-100	1
Fun_VK95_c-1	Default	00-003-102	1

Name	SW Configuration	Artnr (config)	Qty
Skive-	M8_stor	04-055-008	3
TorxM8-	TXM8x35	04-000-035	3
VK95_SFA5117_A-1	600-2635	00-400-009	1

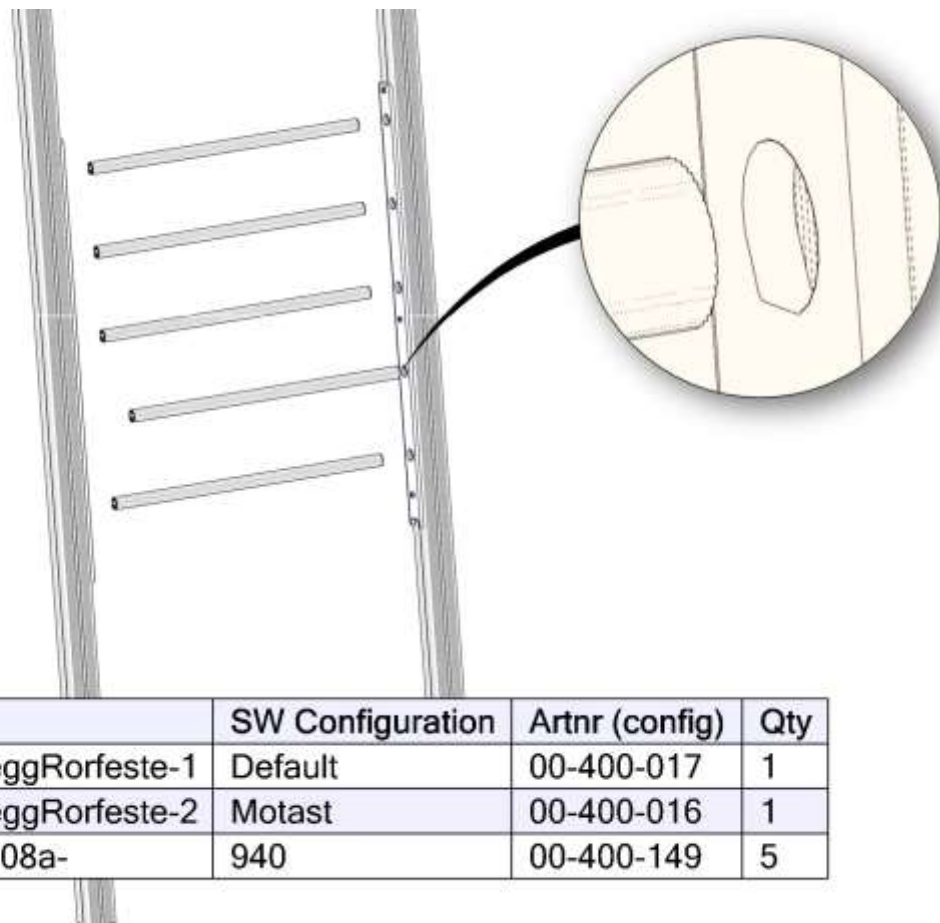

Name	SW Configuration	Artnr (config)	Qty
RibbeveggRorfeste-1	Default	00-400-017	1
RibbeveggRorfeste-2	Motast	00-400-016	1
SFA_5108a-	940	00-400-149	5

Montering av lekeapparatet / Assembly instructions / Montering av lekredskapet

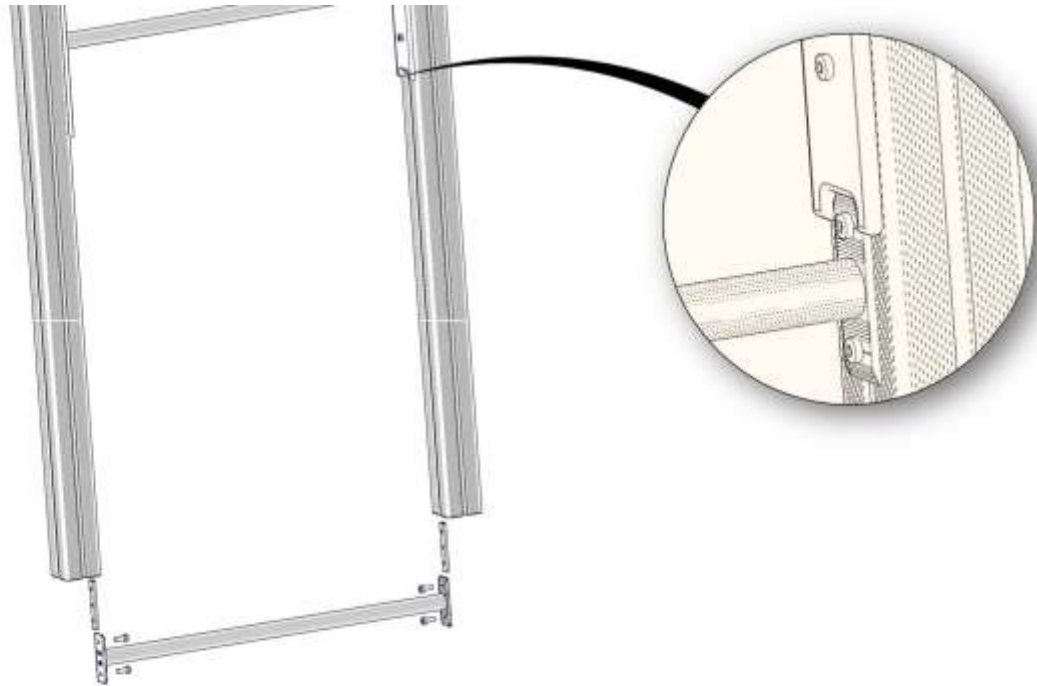

Name	SW Configuration	Artnr (config)	Qty
brikke_SFA5116-1	120_3T	04-060-120	2
Sperror_SFA5110-1	940-12	07-150-062	1
TorxM8-	TXM8x25	04-000-025	4

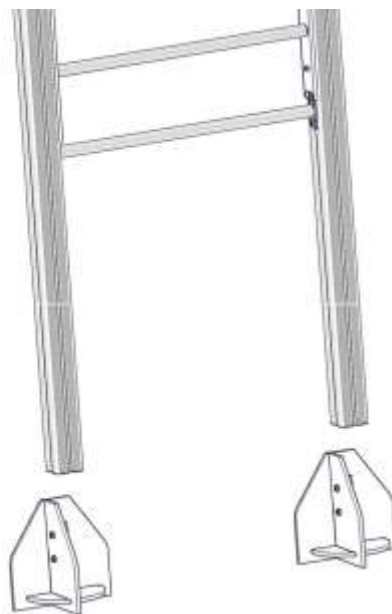

Name	SW Configuration	Artnr (config)	Qty
brikke_SFA5116-1	120_3T	04-060-120	2
brikke_SFA5116-2	50_1T	04-060-050	2
Fun_VK95_a-1	Default	00-003-101	2
Fun_VK95_b-1	Default	00-003-100	2

Name	SW Configuration	Artnr (config)	Qty
Fun_VK95_c-1	Default	00-003-102	2
Skive-	M8_stor	04-055-008	6
TorxM8-	TXM8x35	04-000-035	6

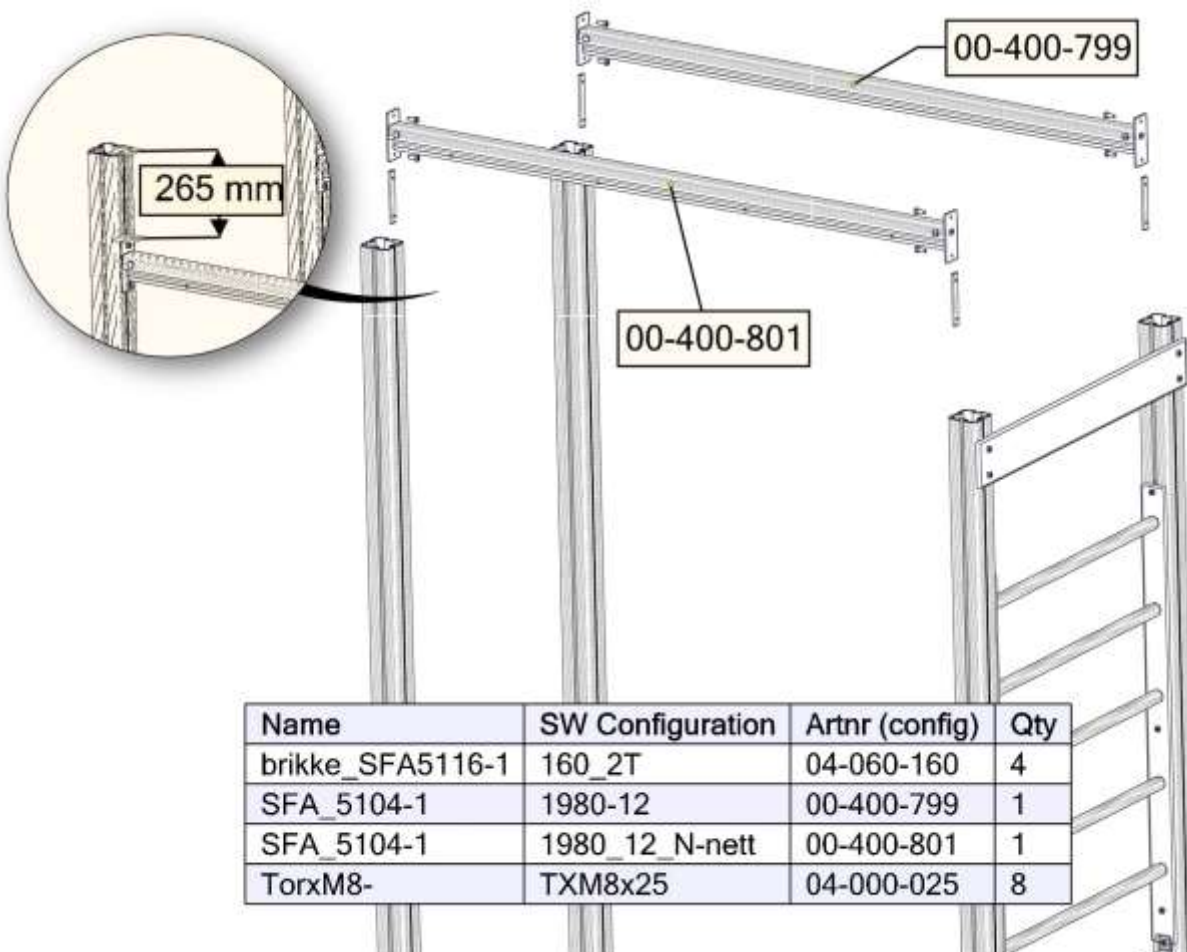
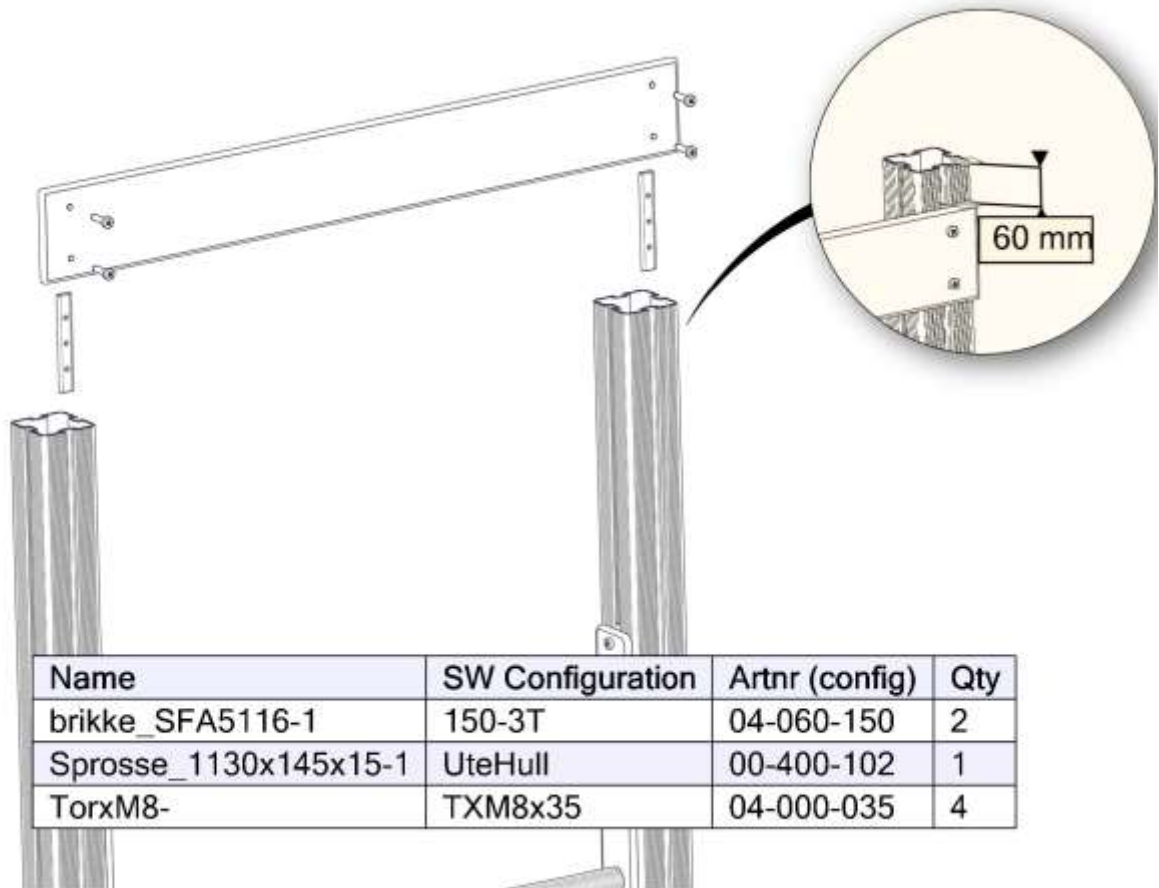

På montert hos Søve

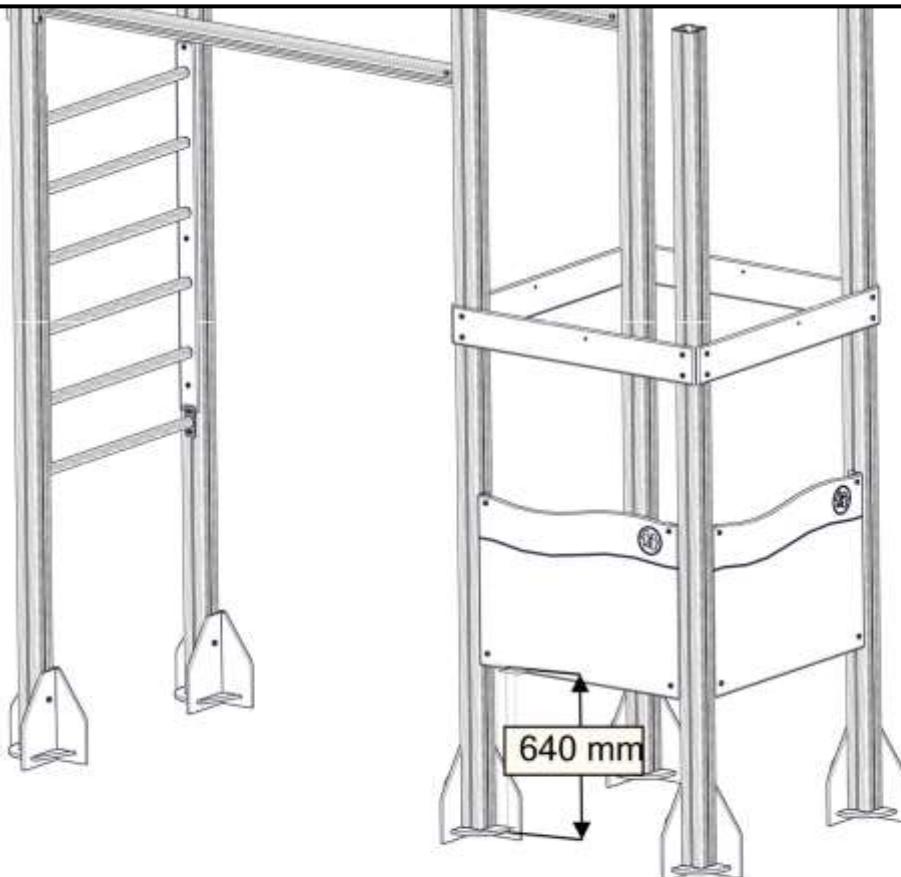
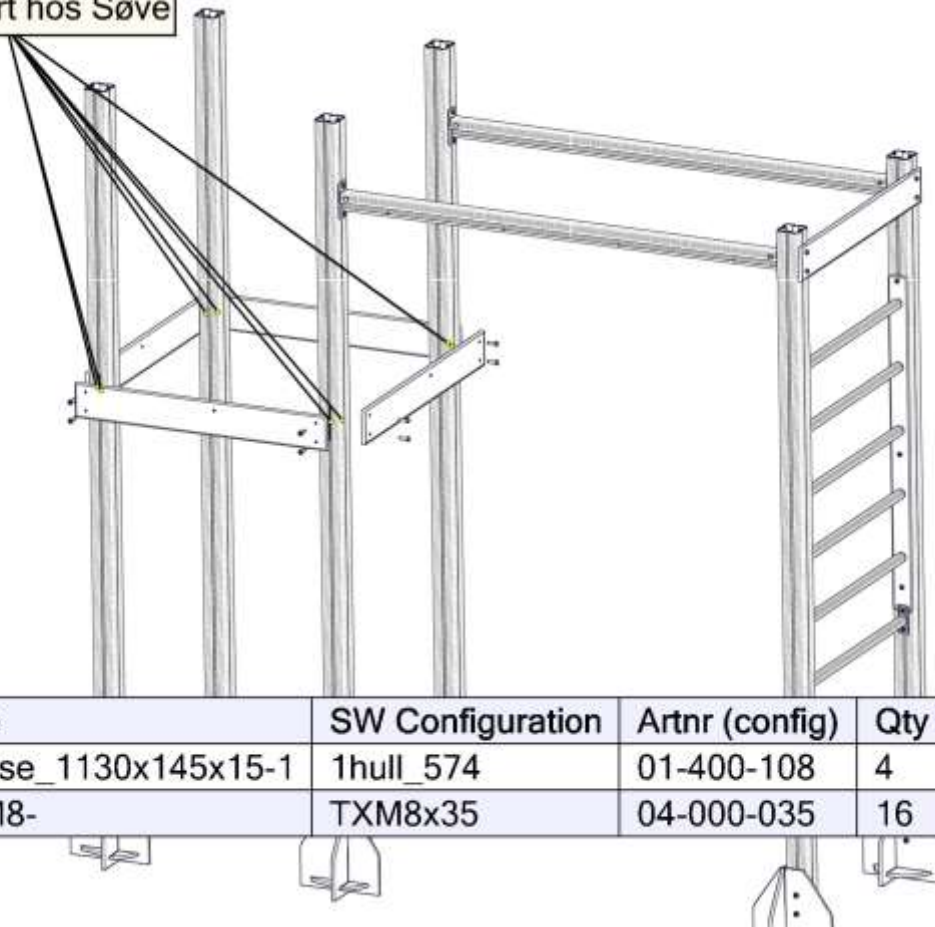

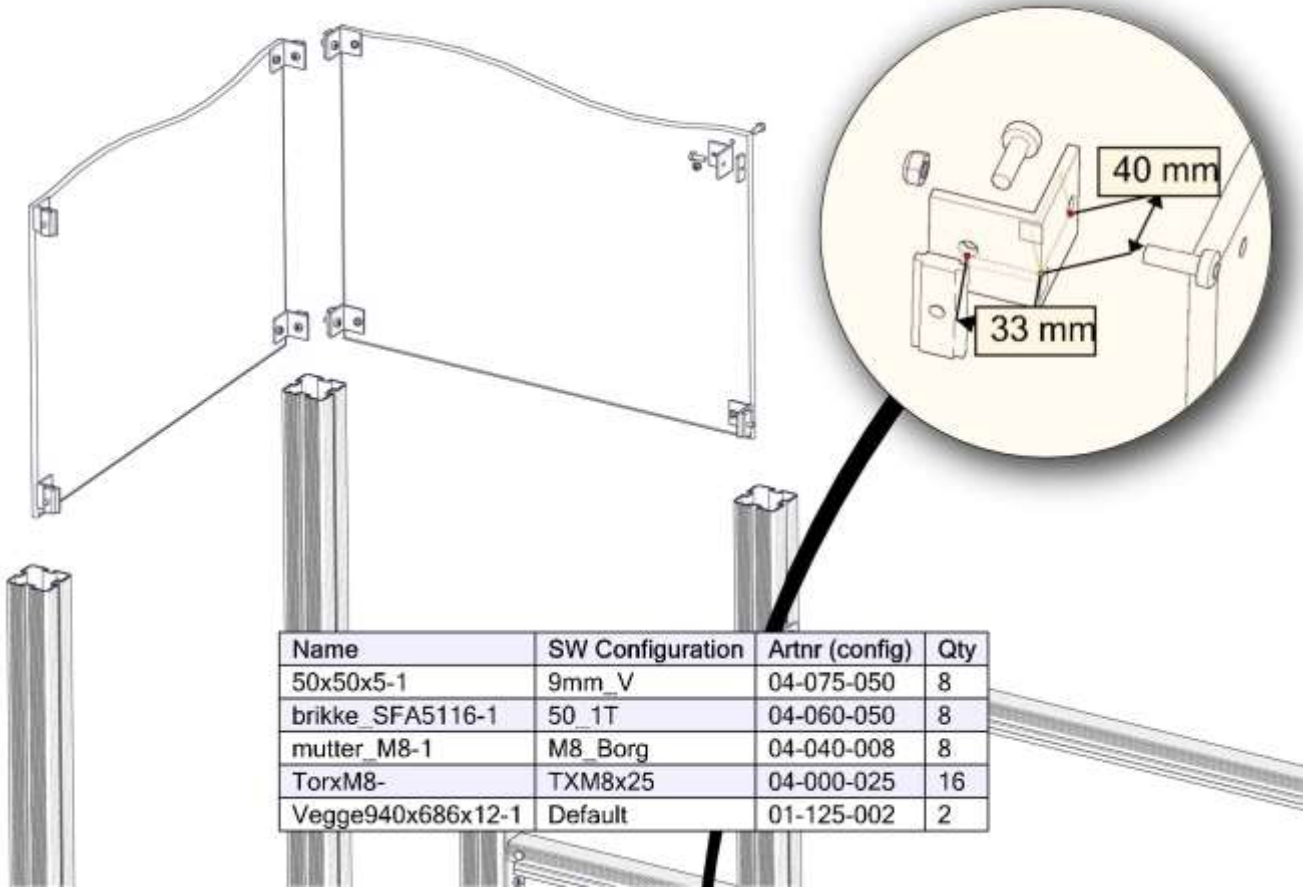

Culvet festes IKKE med vinkler
 The floor is not connected
 Golvet fästes inte med vinkler

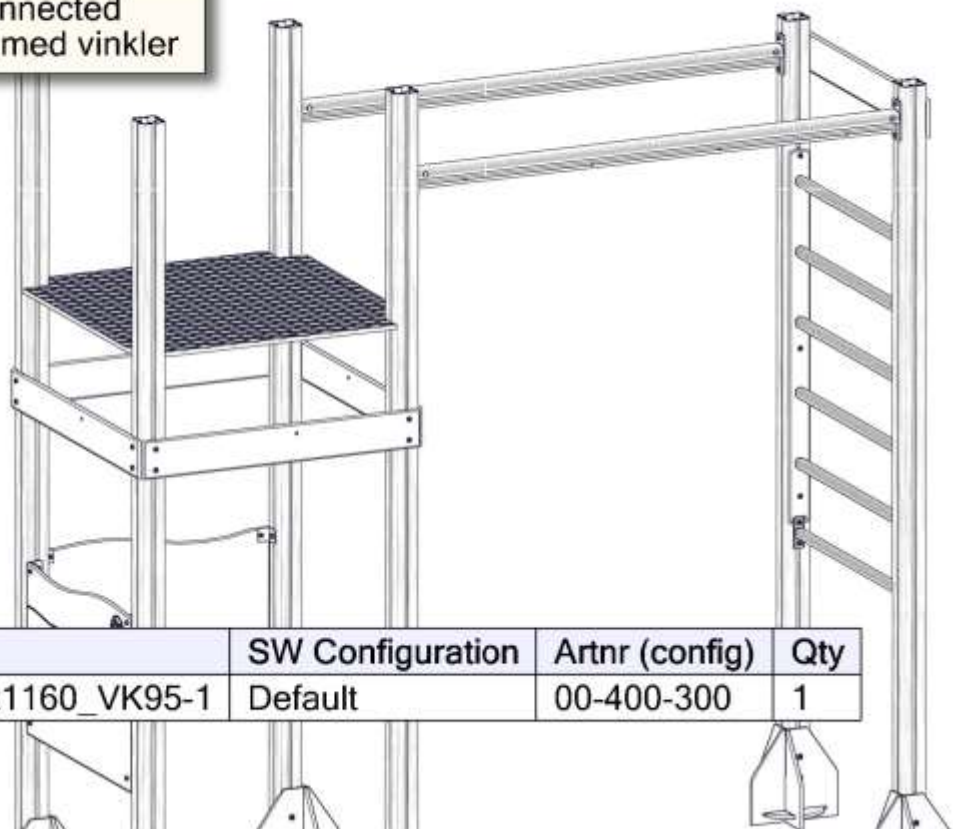

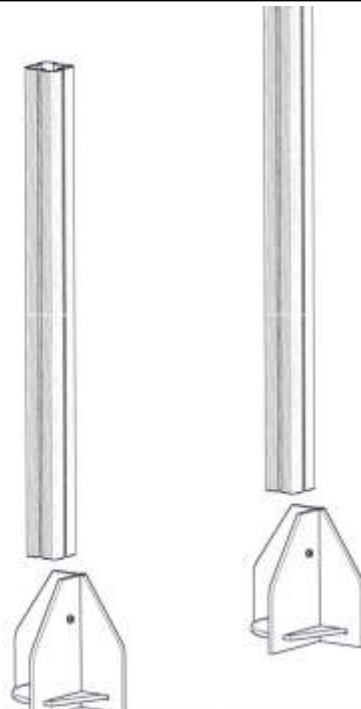
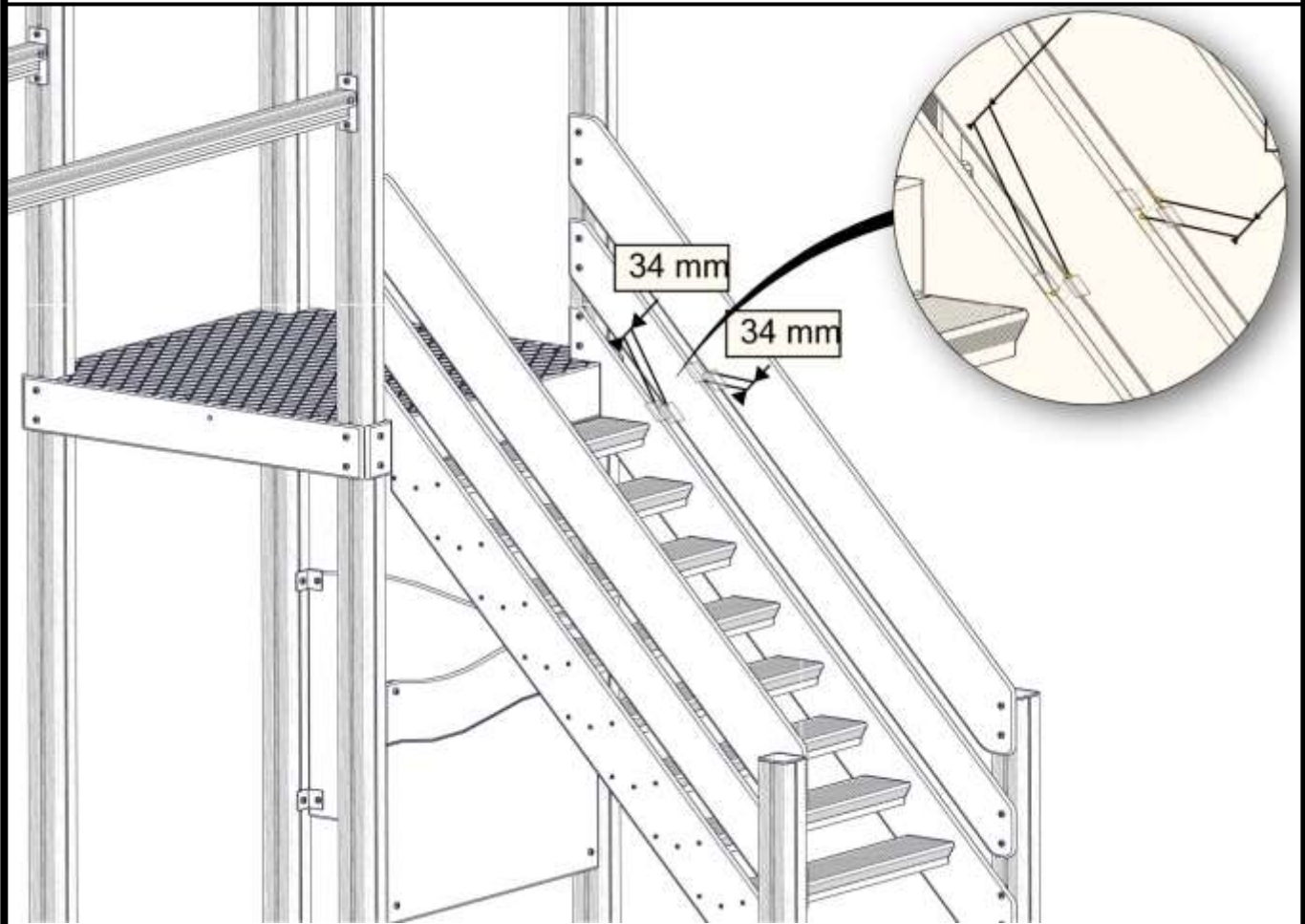

Name	SW Configuration	Artnr (config)	Qty
brikke_SFA5116-1	120_3T	04-060-120	2
brikke_SFA5116-2	50_1T	04-060-050	2
Fun_VK95 a-1	Default	00-003-101	2
Fun_VK95 b-1	Default	00-003-100	2
Fun_VK95 c-1	Default	00-003-102	2

Name	SW Configuration	Artnr (config)	Qty
Skive-	M8_stor	04-055-008	6
TorxM8-	TXM8x35	04-000-035	6
VK95_SFA5117_A-1	600-700	01-129-006	2

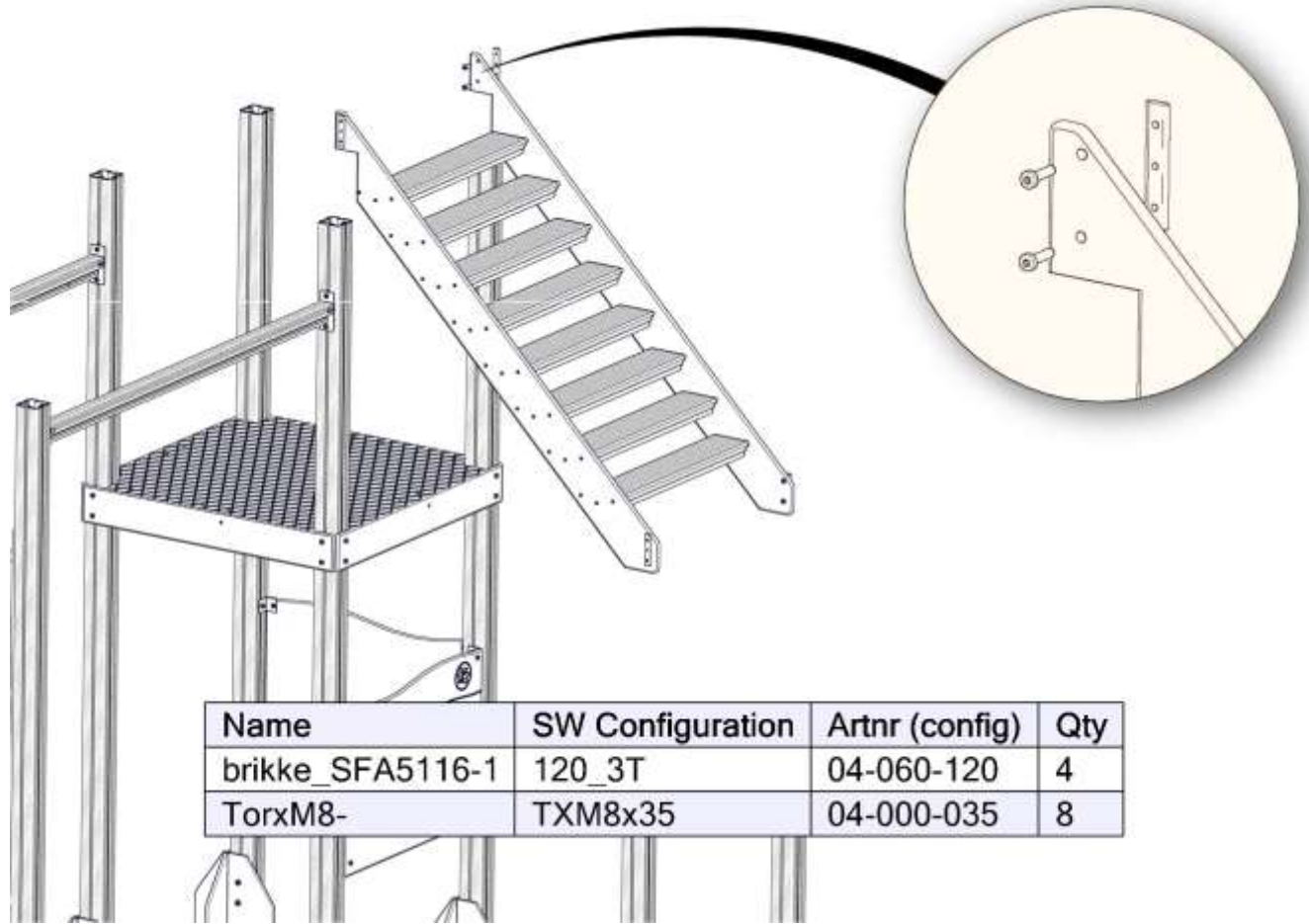

Name	SW Configuration	Artnr (config)	Qty
brikke_SFA5116-1	120_3T	04-060-120	4
TorxM8-	TXM8x35	04-000-035	8

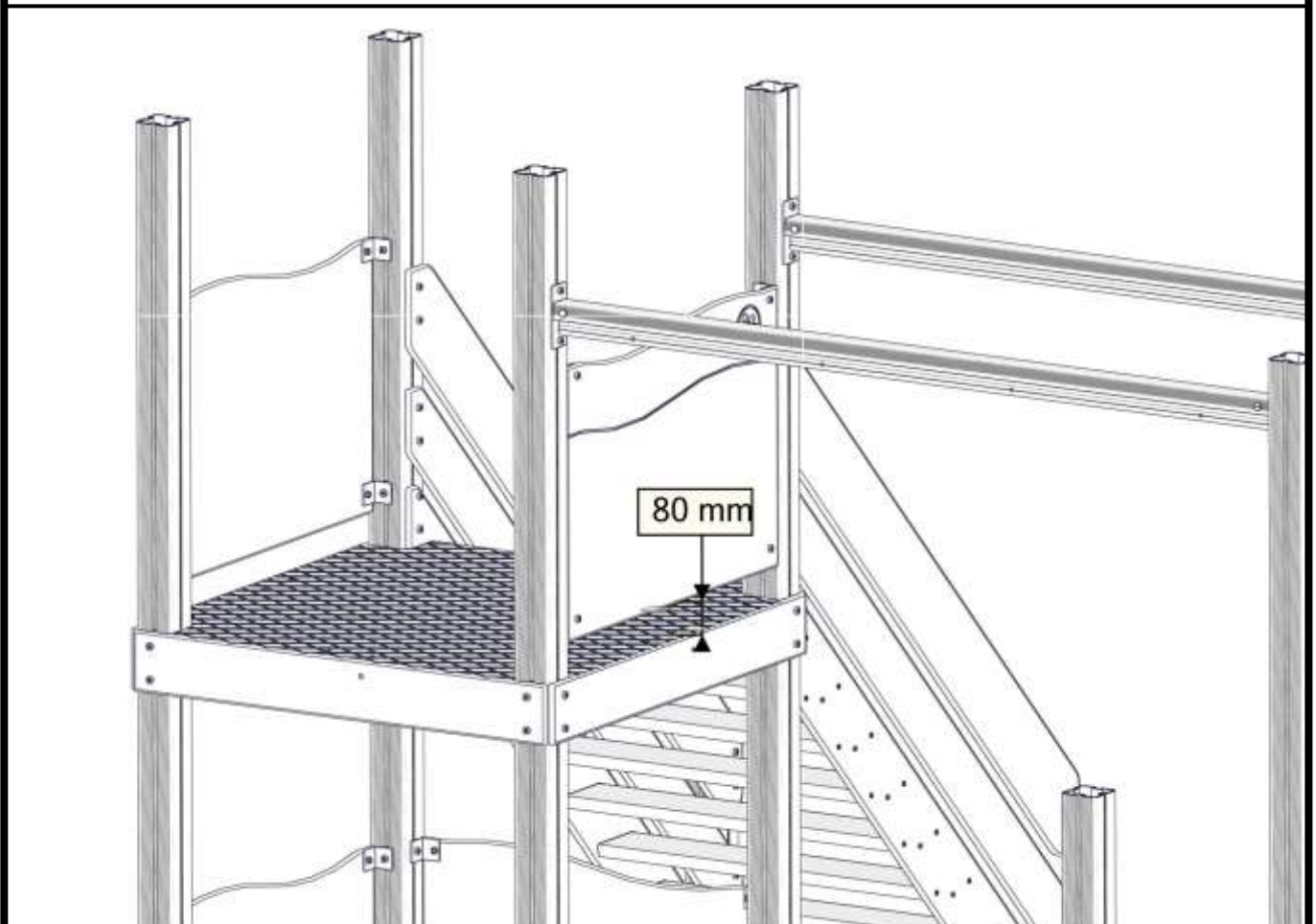
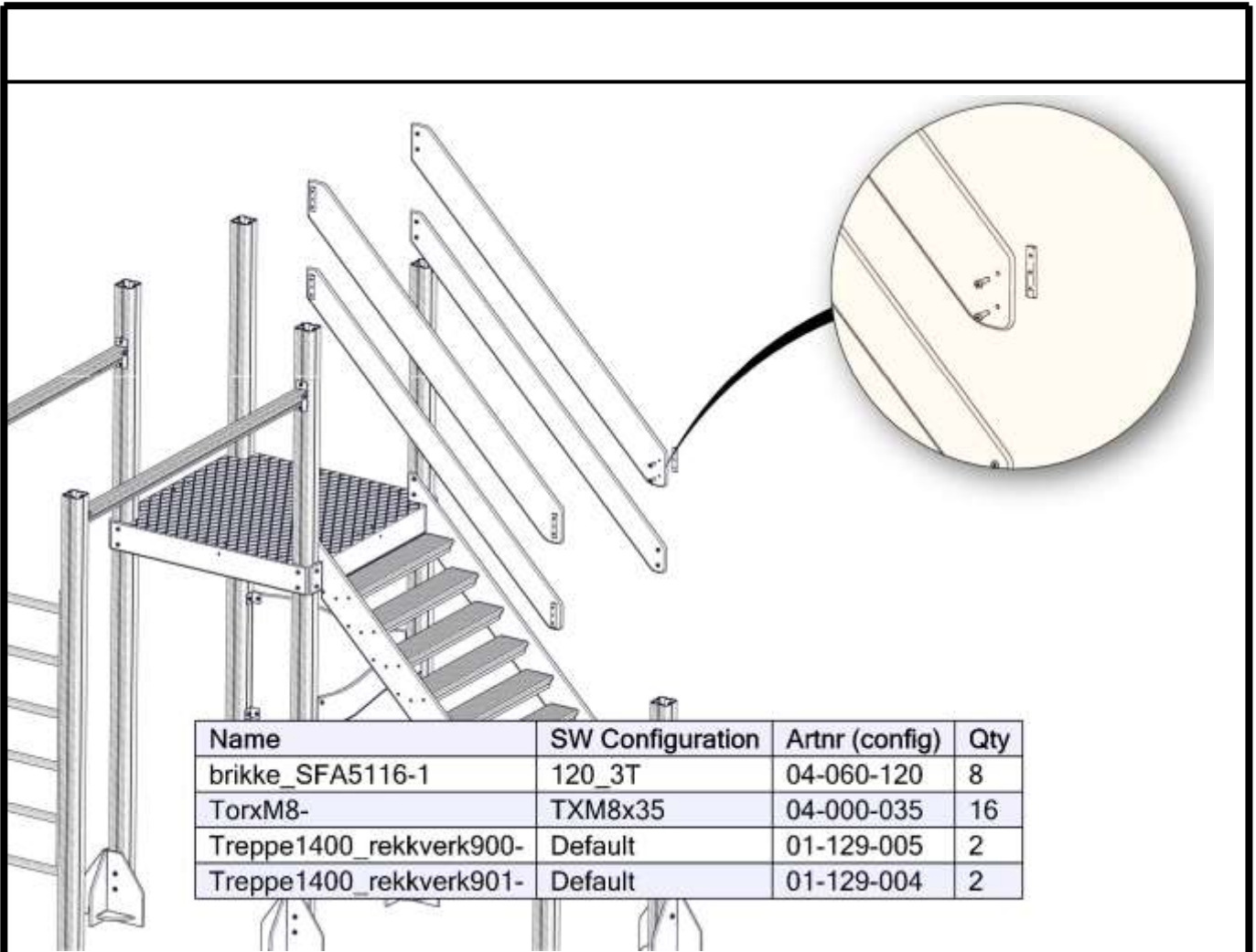

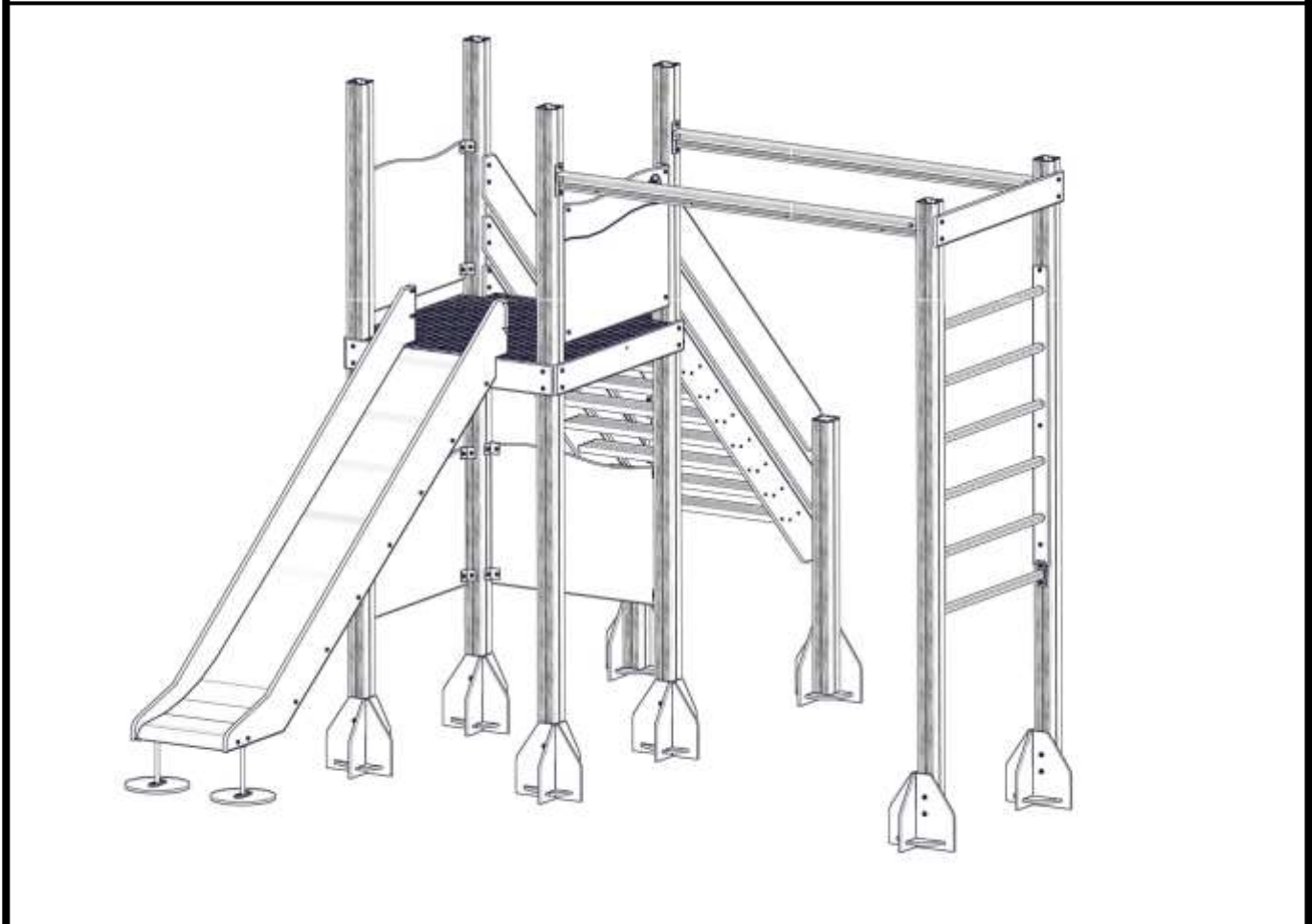
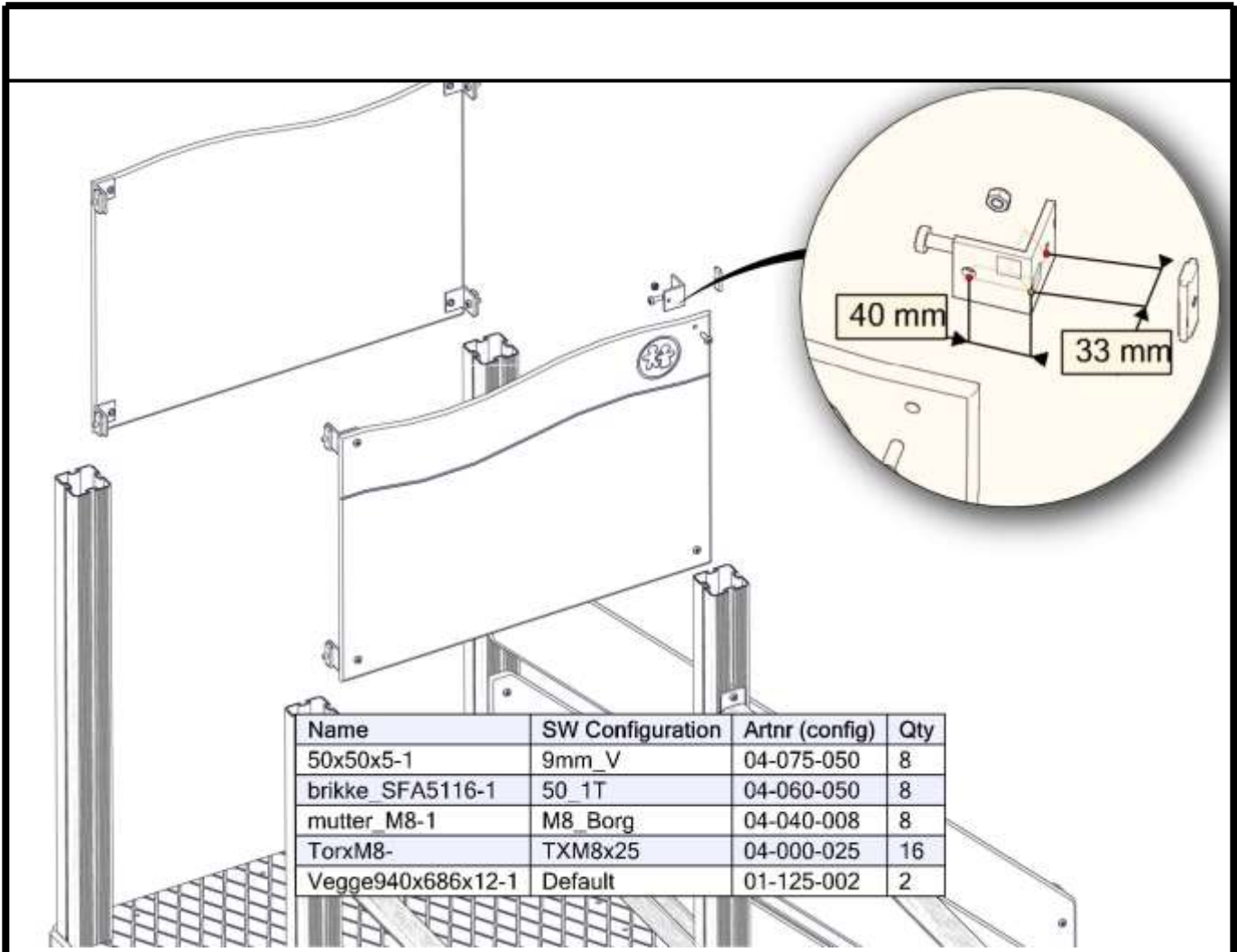

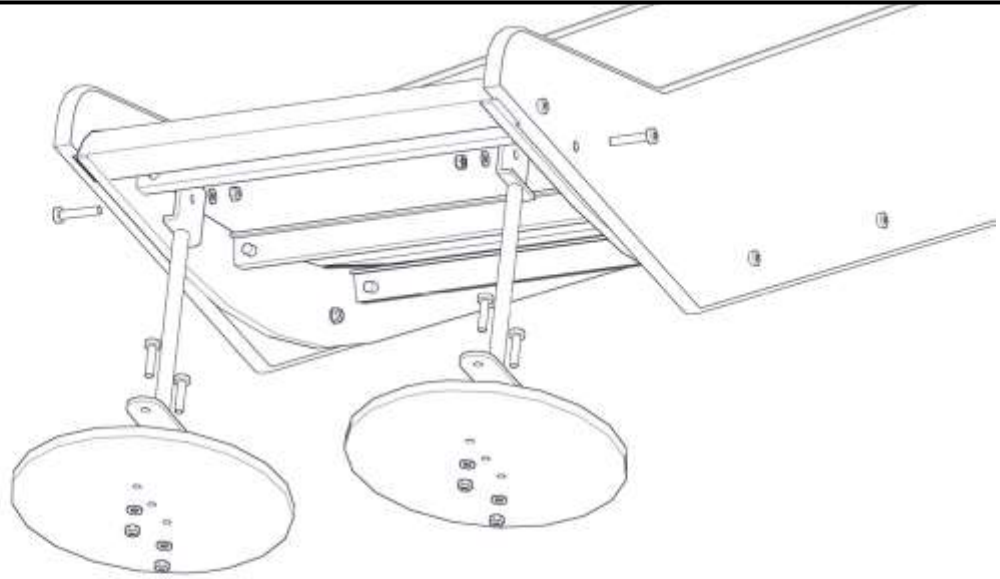

Name	SW Configuration	Artnr (config)	Qty
Fundament platte 2H-1	Hoh80	00-003-106	2
mutter M8-	M8 Borg	04-040-008	6
Skive-	M8	04-050-008	6
Stalforankring-1	liten	00-100-312	2
TorxM8-	TXM8x35	04-000-035	4
TorxM8-1	TXM8x45	04-000-045	2

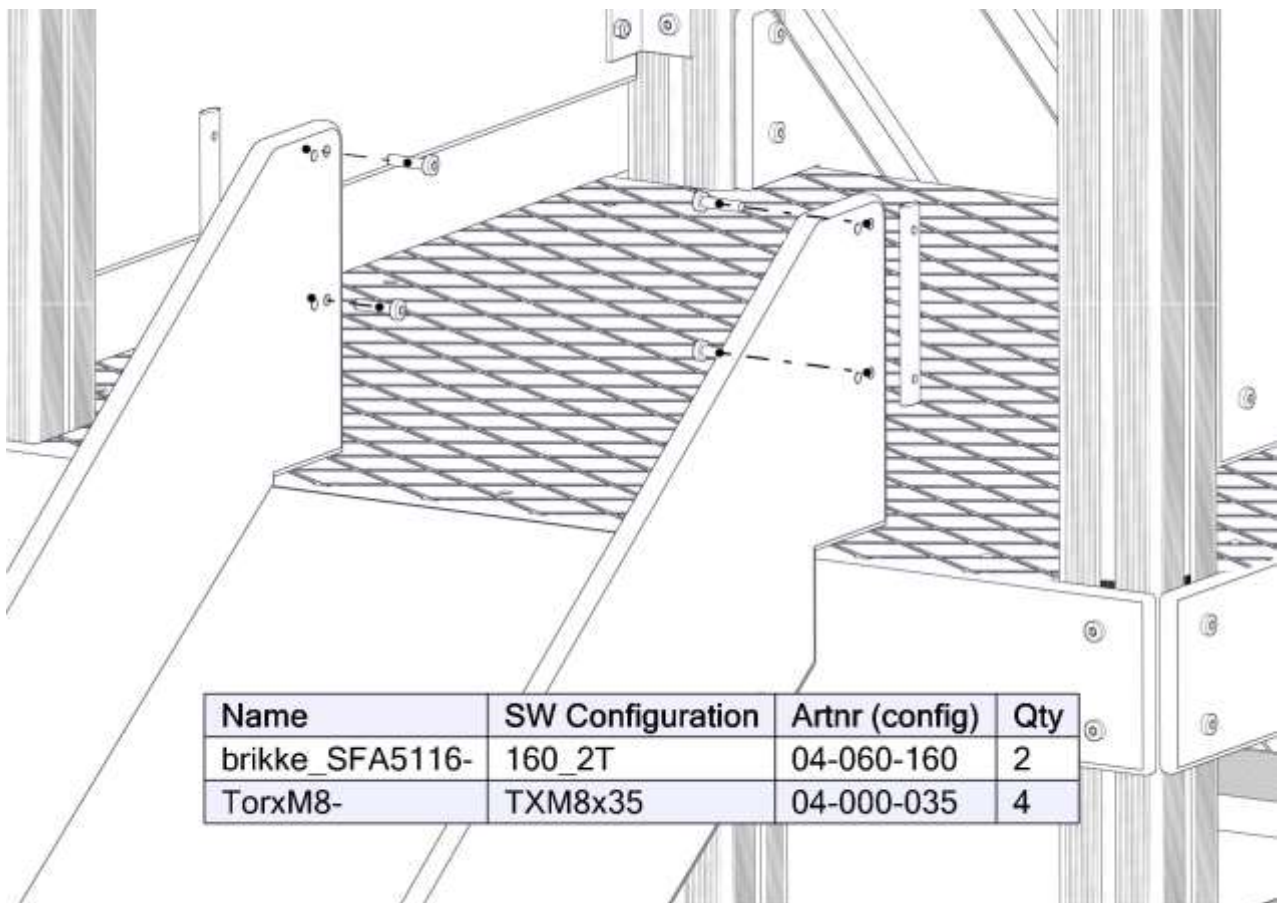

Name	SW Configuration	Artnr (config)	Qty
brikke_SFA5116-	160_2T	04-060-160	2
TorxM8-	TXM8x35	04-000-035	4

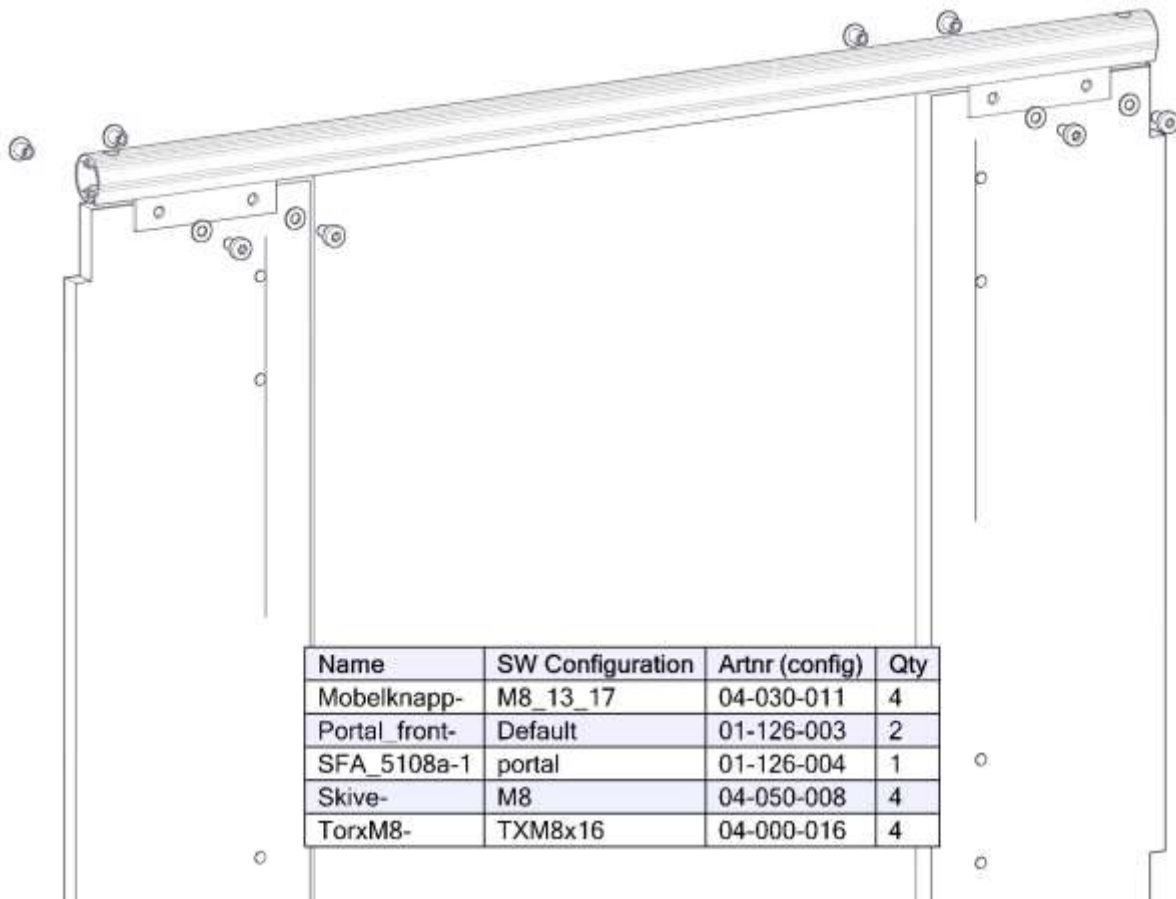
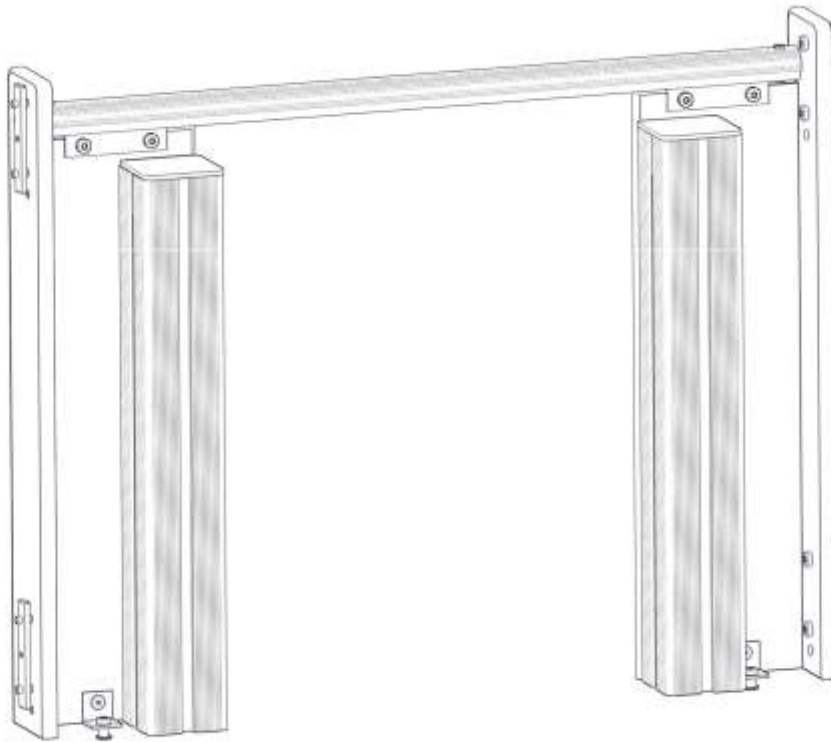

Name	SW Configuration	Artnr (config)	Qty
Mobelknapp-	M8_13_17	04-030-011	4
Portal front-	Default	01-126-003	2
SFA_5108a-1	portal	01-126-004	1
Skive-	M8	04-050-008	4
TorxM8-	TXM8x16	04-000-016	4

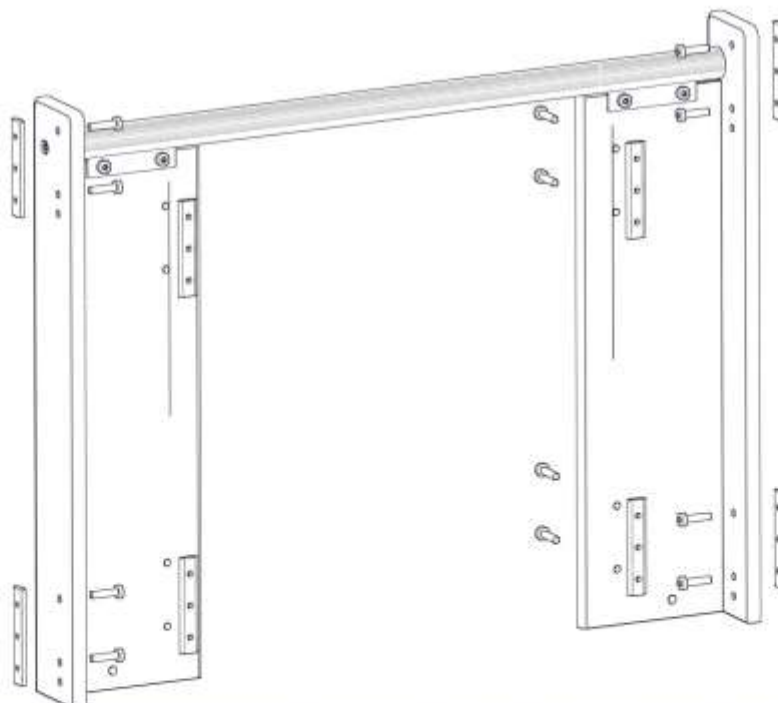
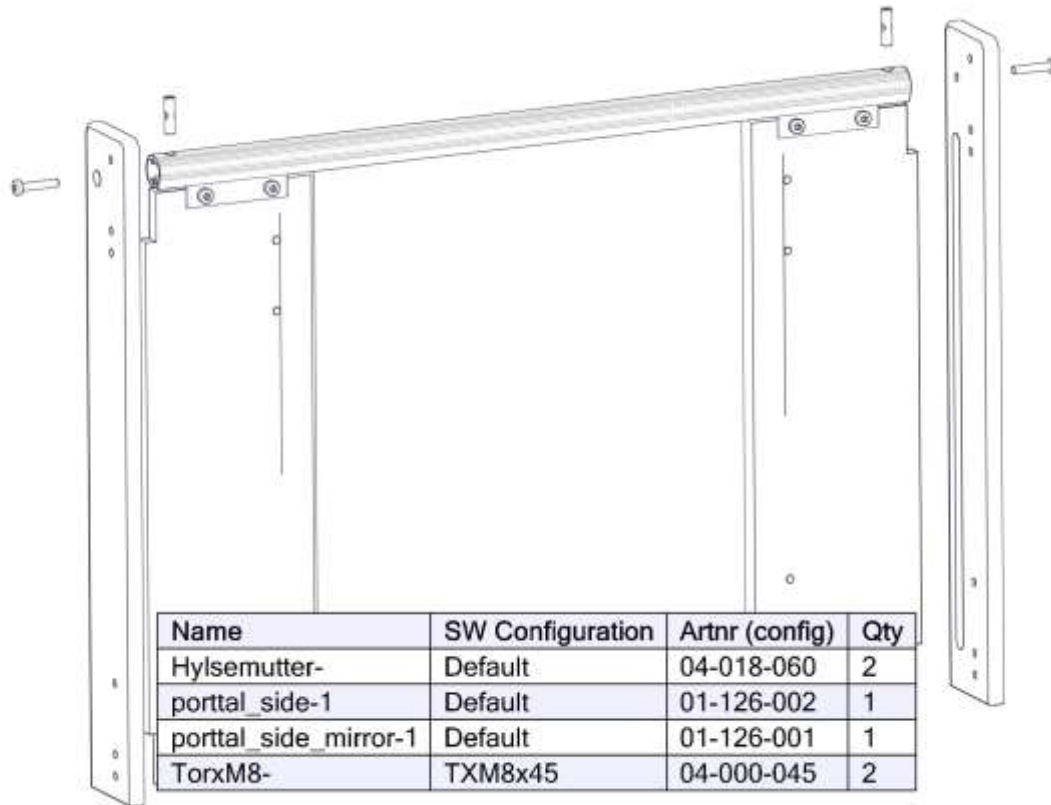

Name	SW Configuration	Artnr (config)	Qty
brikke_SFA5116-1	120_3T	04-060-120	8
TorxM8-	TXM8x35	04-000-035	16

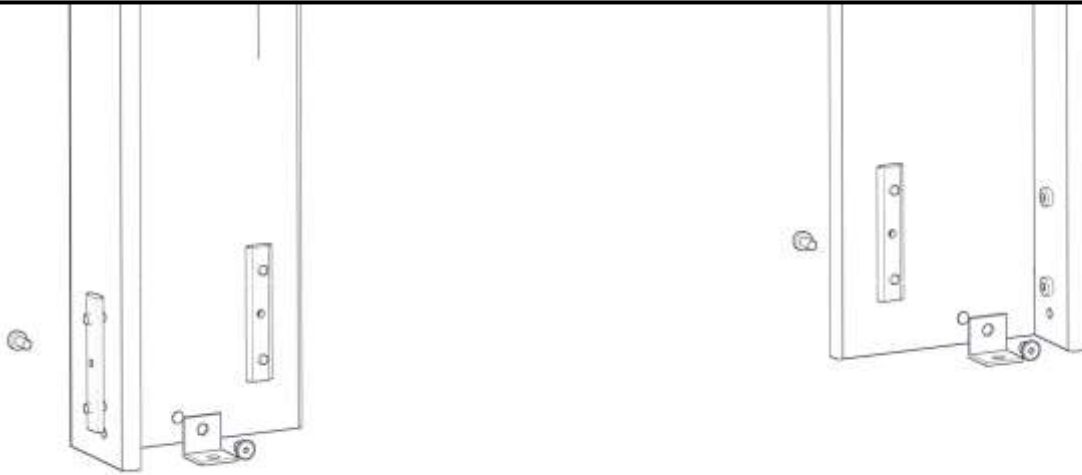

Name	SW Configuration	Artnr (config)	Qty
35x35x3-	11mm	04-070-036	2
Mobelknapp-	M8_13_17	04-030-011	2
TorxM8-	TXM8x16	04-000-016	2

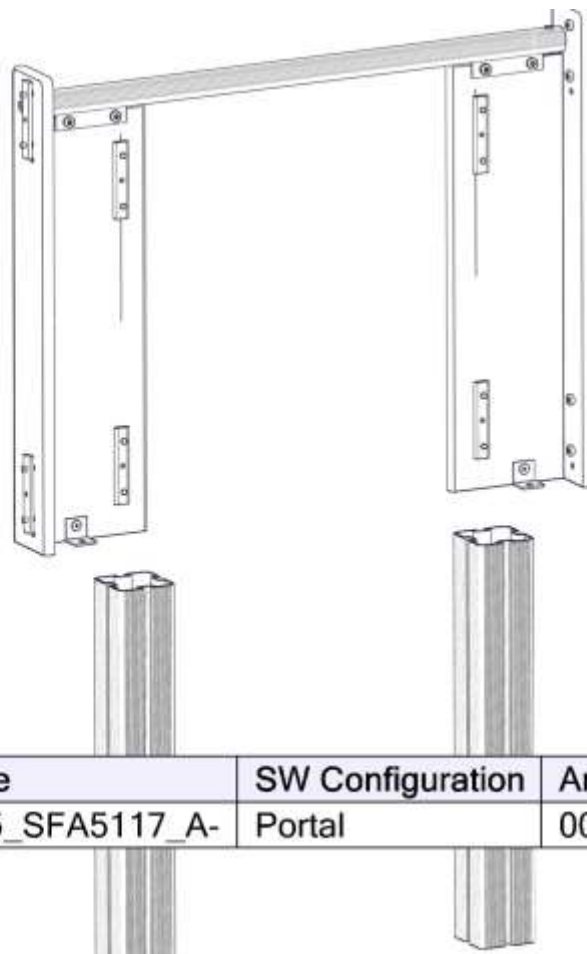

Name	SW Configuration	Artnr (config)	Qty
VK95_SFA5117_A-	Portal	00-400-009	2

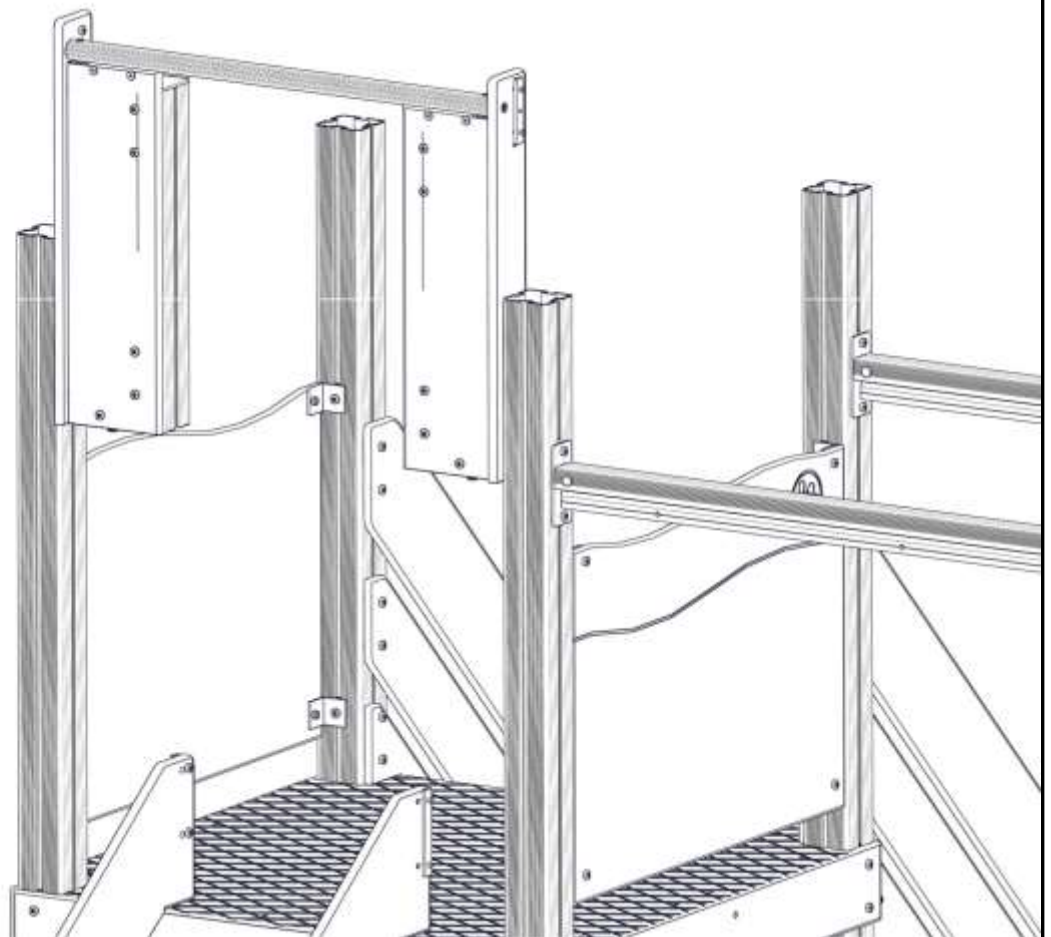
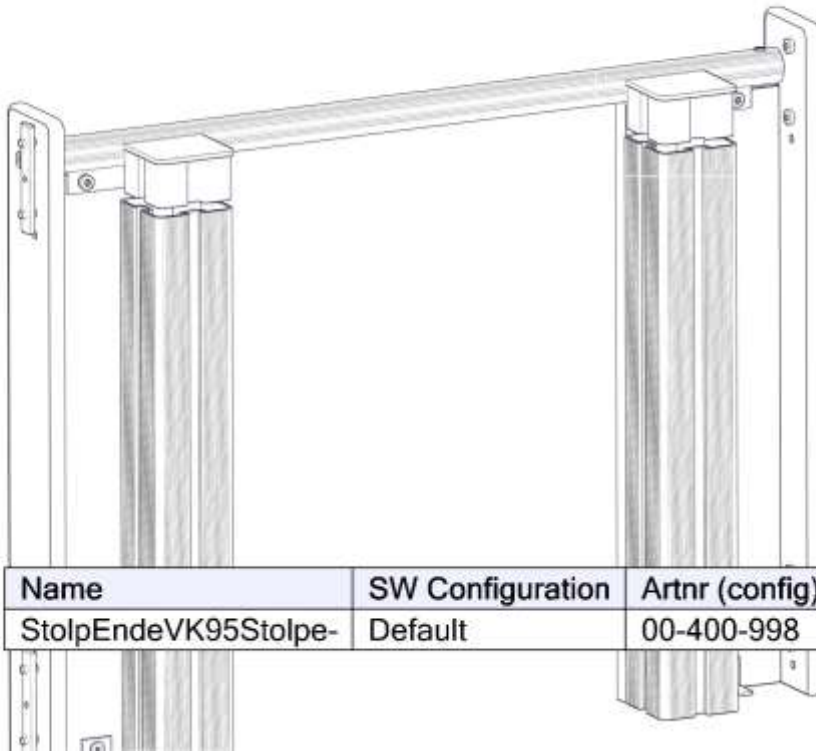

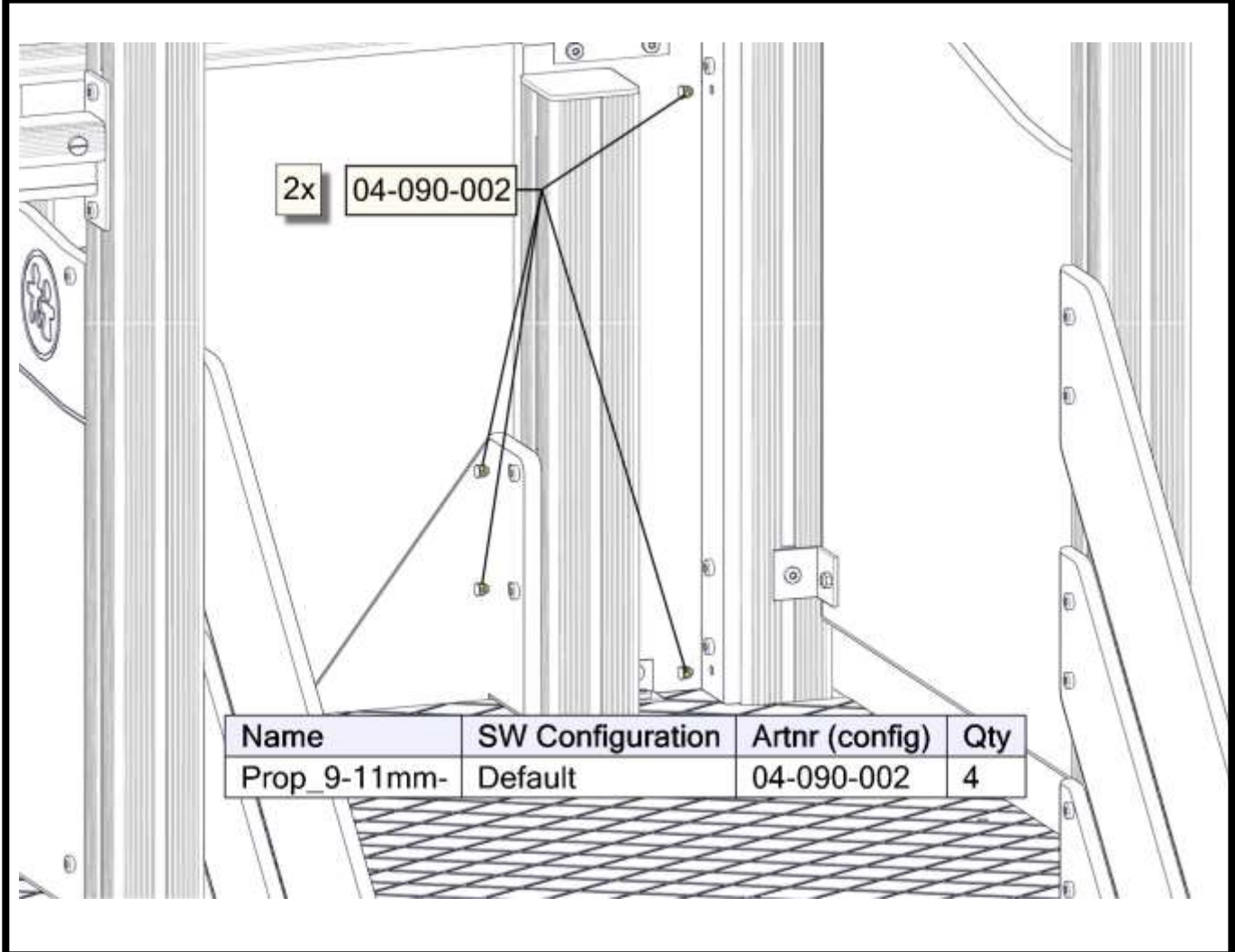
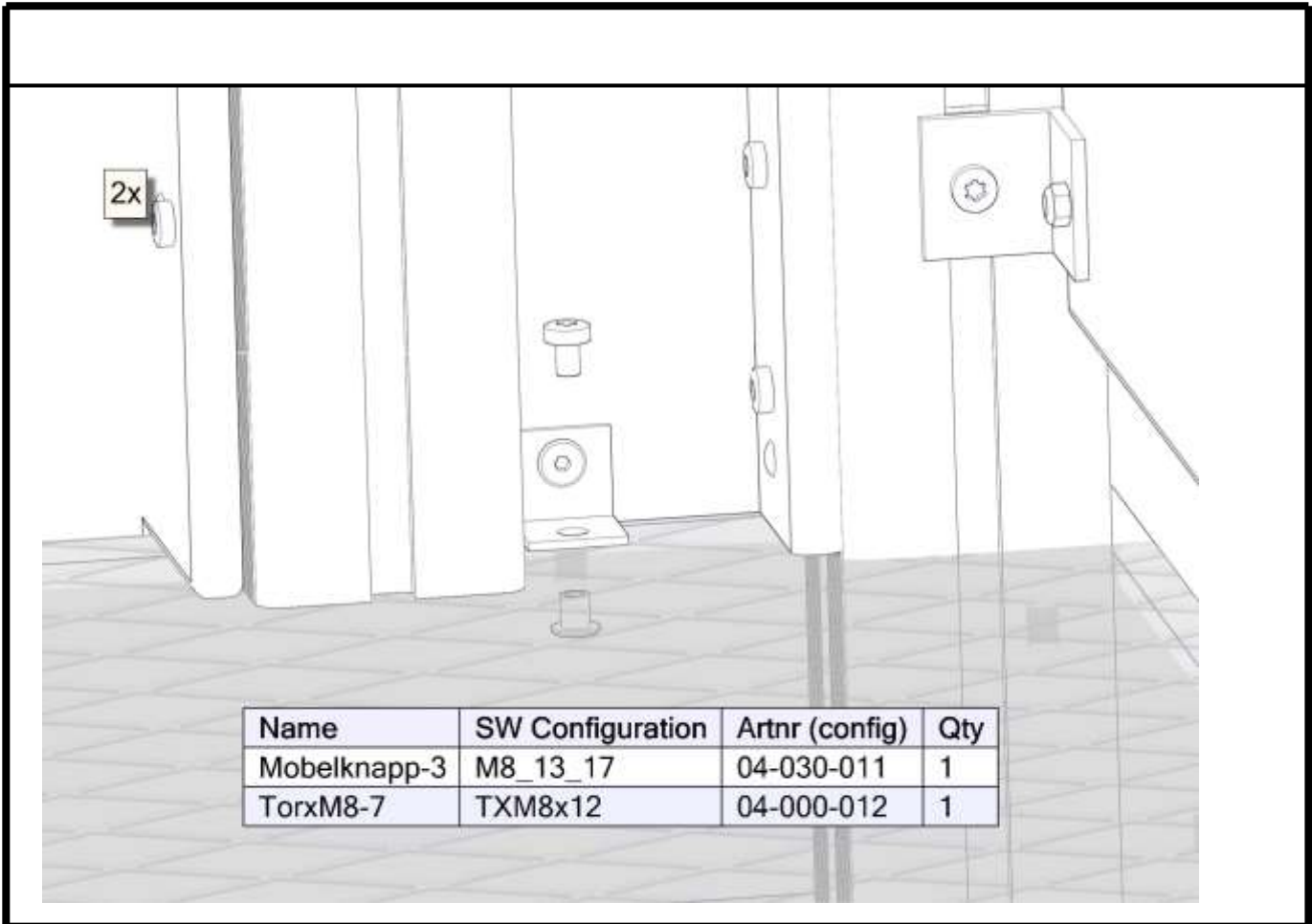

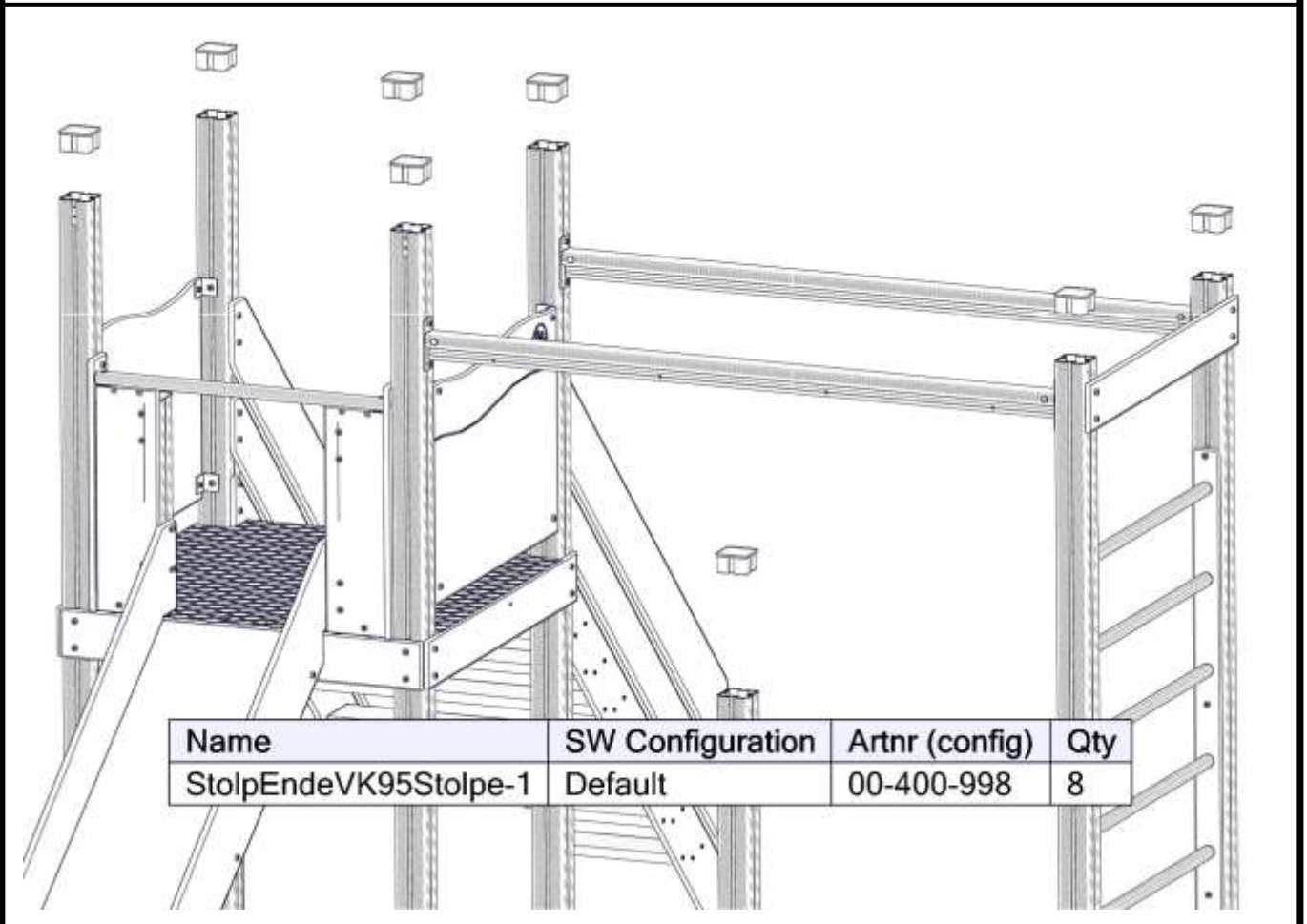
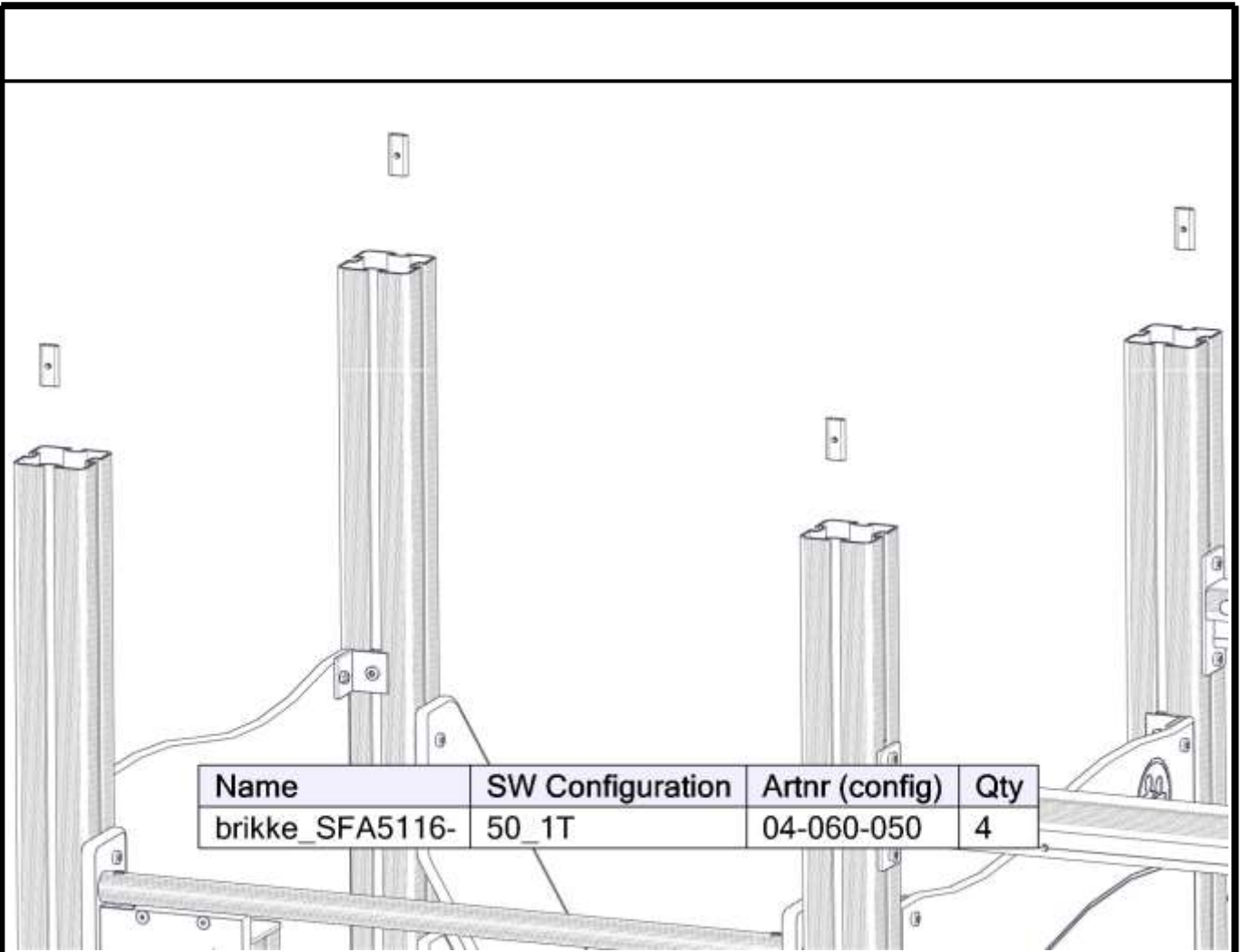

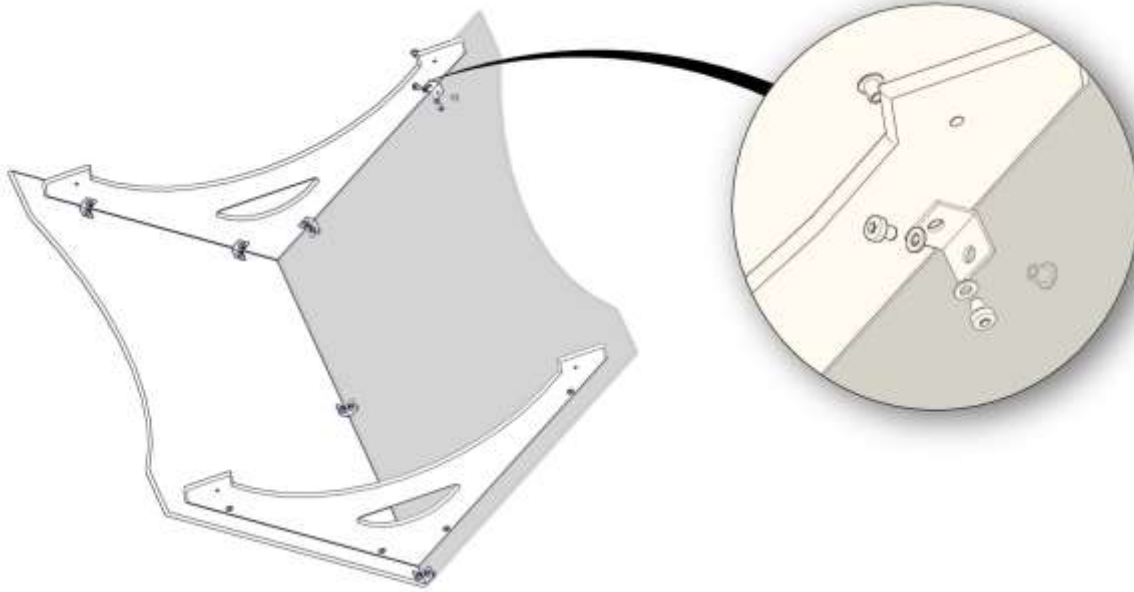

Name	SW Configuration	Artnr (config)	Qty
35x35x3-1	11mm	04-070-036	11
Mobelknapp-	M8 13 17	04-030-011	22
Skive-	M8	04-050-008	22
takGavelplate-	Default	01-128-002	2

Name	SW Configuration	Artnr (config)	Qty
TakPlate-	Default	01-128-001	2
TorxM8-	TXM8x12	04-000-012	22

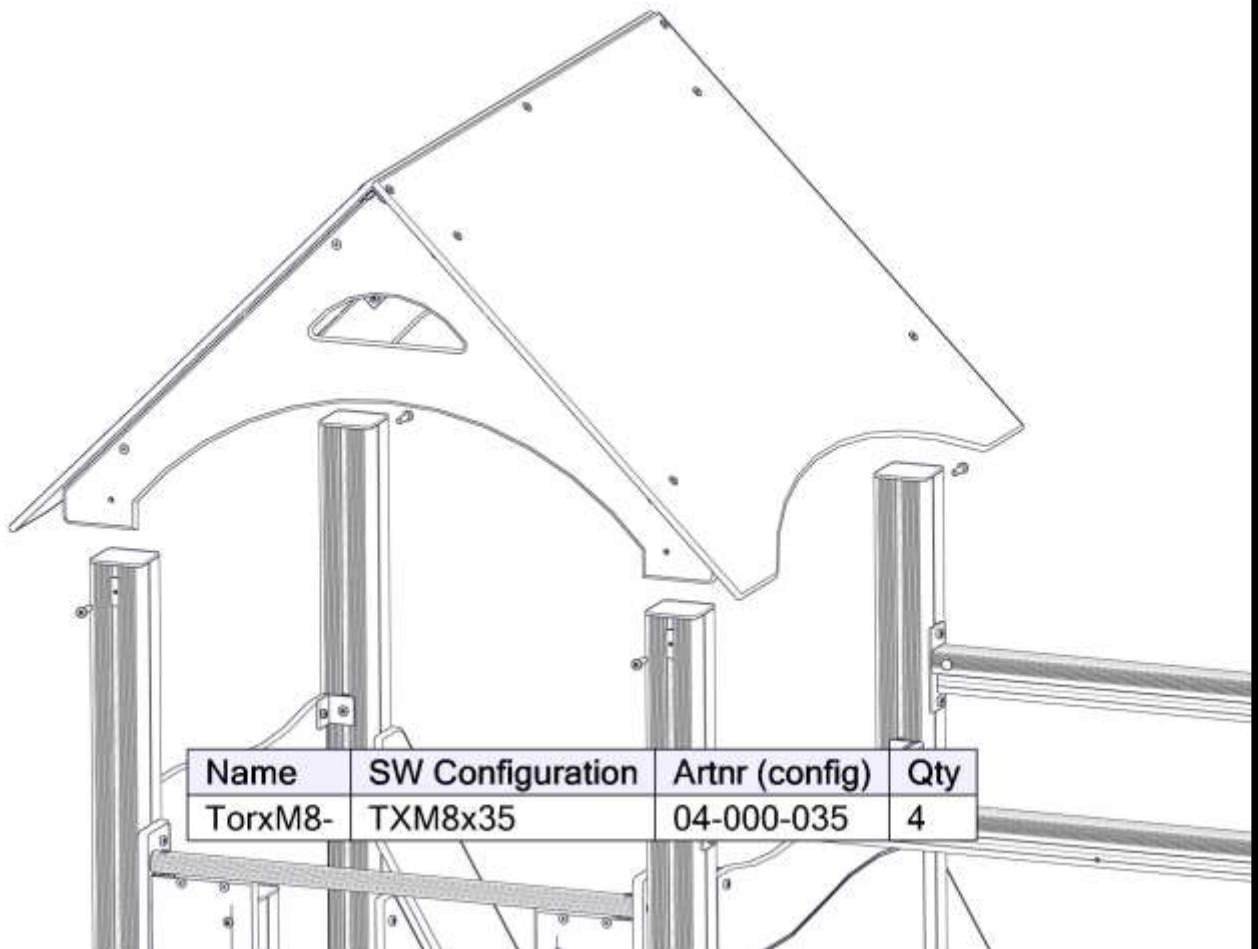

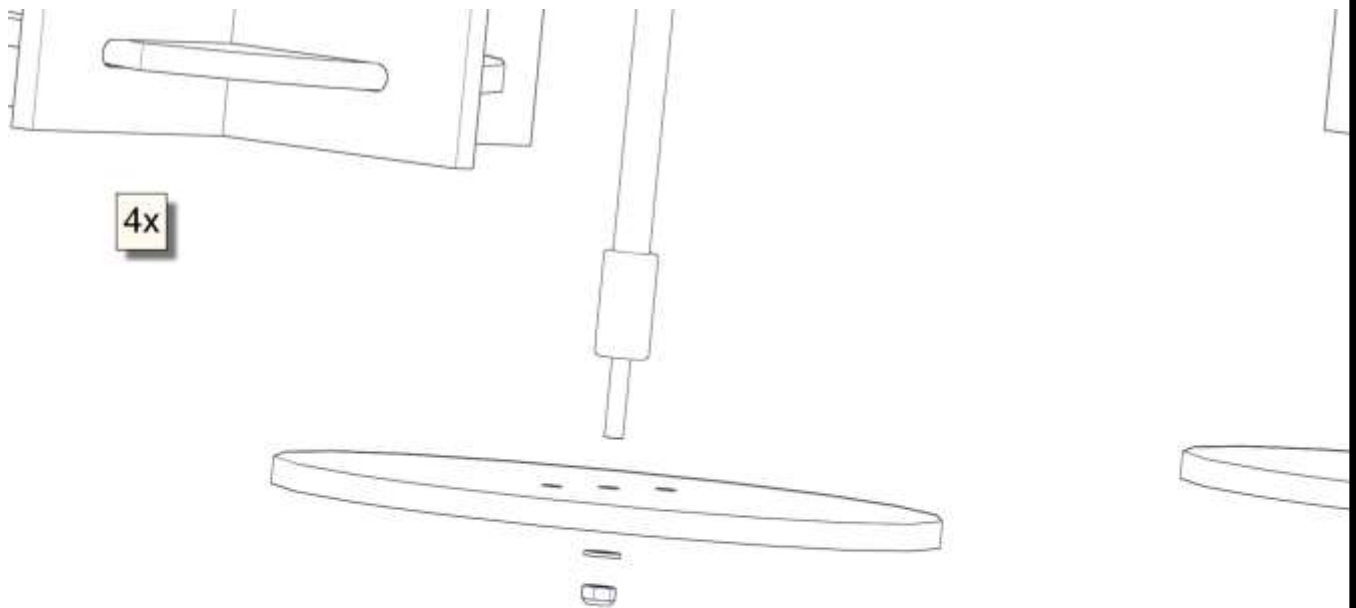
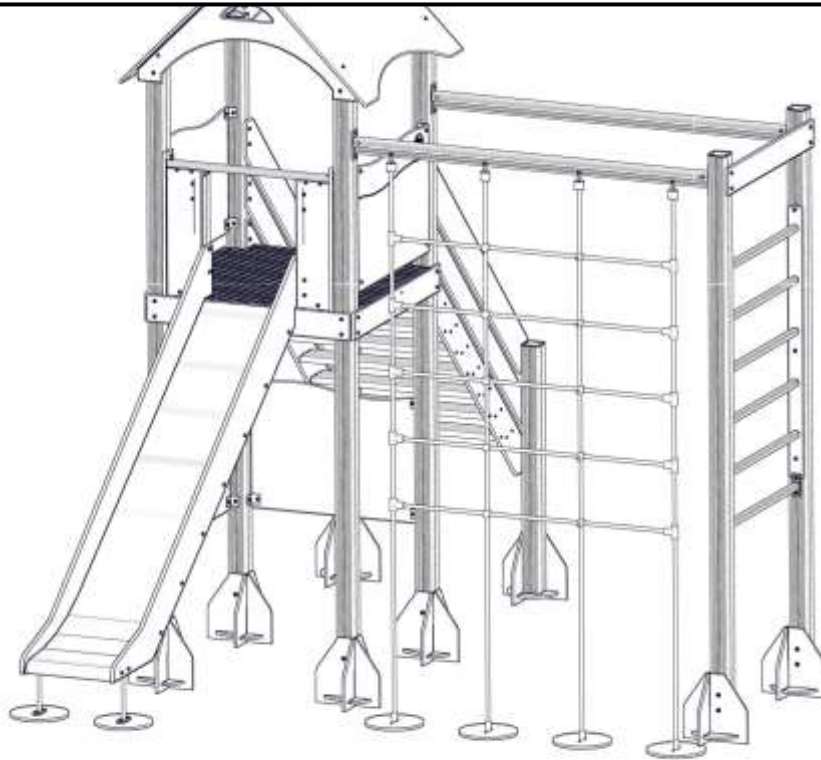



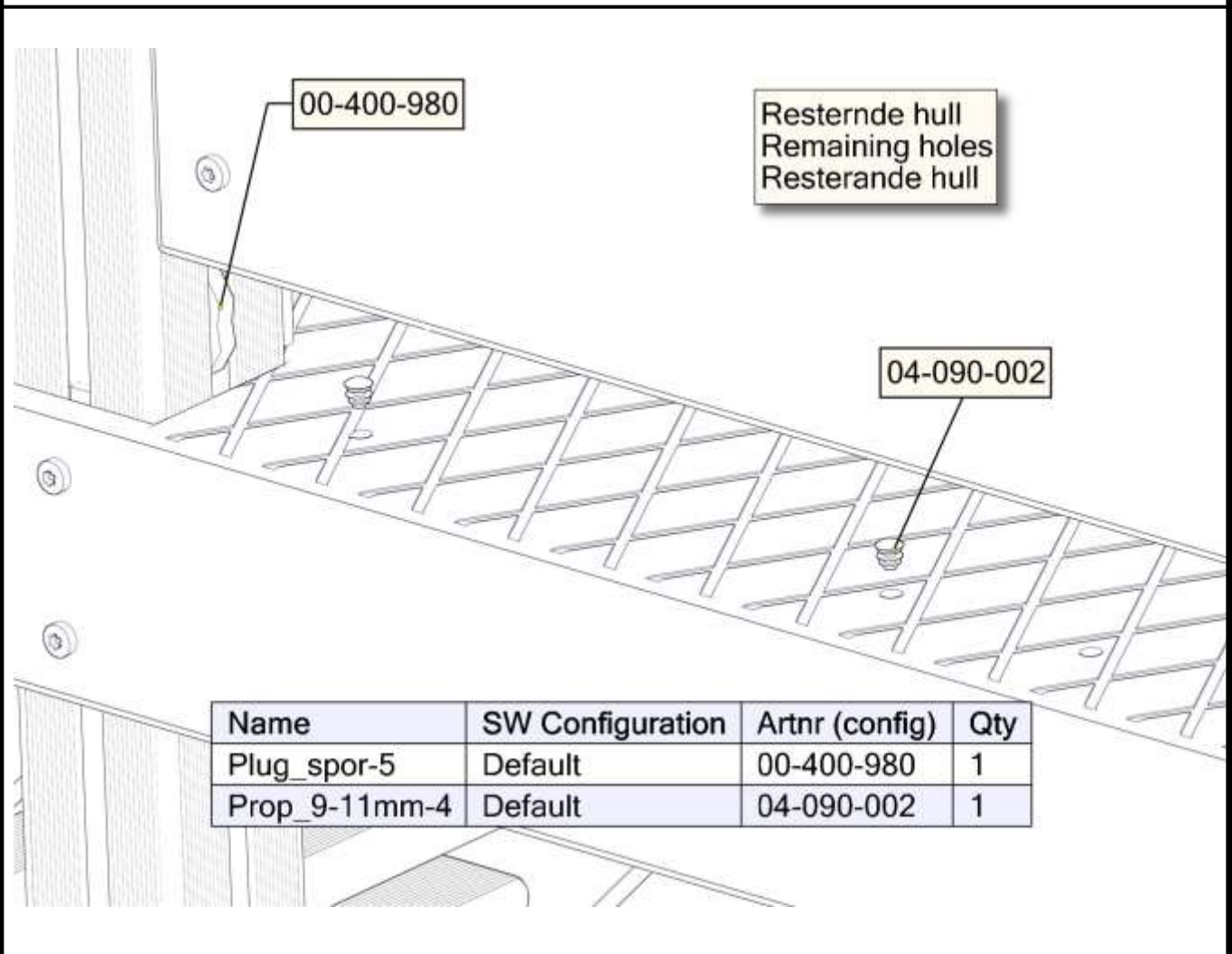
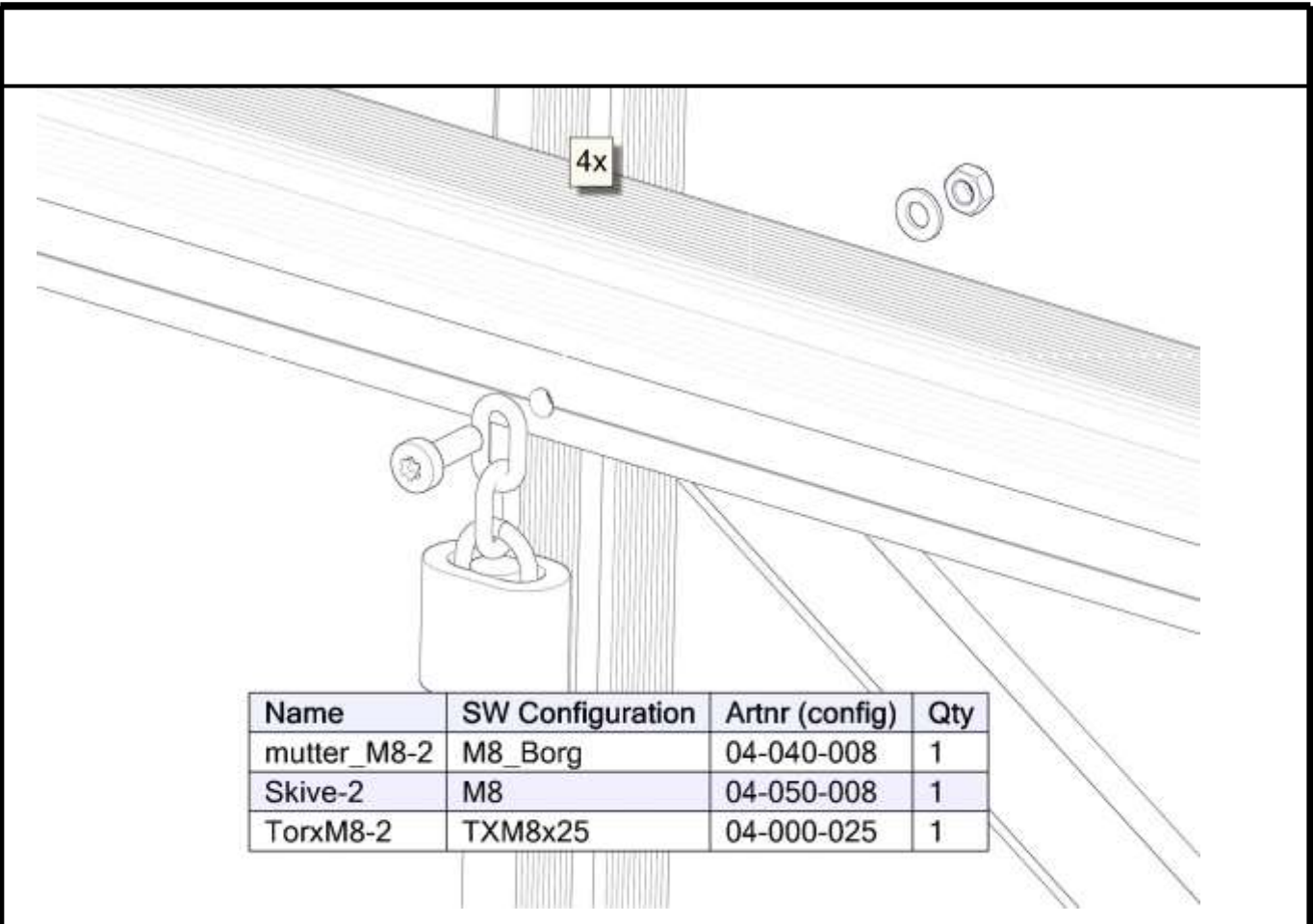





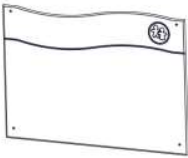





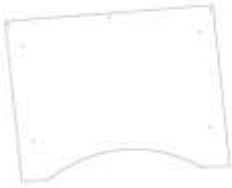







Name	SW Configuration	Artnr (config)	Qty
Fundament_platte_2H-1	Hoh80	00-003-106	1
mutter_M8-5	M8_Borg	04-040-008	1
Skive-5	M8	04-050-008	1



Før utstyret tas i bruk / Before play begins / Innan lekredskapet tas i bruk	
N	<ul style="list-style-type: none"> ● Påse at fallunderlag er utlagt i henhold til gjeldende regler eller vår anbefaling ● Fjern alle monteringshjelpemidler (rester av betong, planker, paller, plast, og lignende) ● Før utstyret tas i bruk, burde man sjekke at det ikke er fare for at anorakksnorer og lignende som kan hekte seg fast noen steder på lekeapparatet. (Vedlagte snor med dobbe (kneledd) kan brukes til å sjekke at dette er i orden. Se vedlagte veiledning for bruk av denne. Dette gjøres for å oppdage eventuelle feilmonteringer.?) ● NB! Bør stå i 2-3 dager før bruk
EN	<ul style="list-style-type: none"> ● Make sure the area and depth of safer surfacing are according to the current standard, or to the manufacturer's recommendation ● Make sure all tools and surplus materials are removed before play begins ● PS! When complete, allow 2-3 days for the concrete to set before use
S	<ul style="list-style-type: none"> ● Kontrollera att fallunderlag är utlagt enligt gällande regler eller vårt rekommendation ● Ta bort alla monteringshjälpmedel (rester av betong, plankor, pallar, plast och liknande) ● Innan lekredskapet används, kontrollera att anoracksnoddar eller kläder/delar av kläder eller liknande inte kan fastna i några delar på redskapet. (Den bipackade "knävringen" kan man med fördel användas för denna kontroll. ● Detta görs för att upptäcka eventuella felmonteringar.)

Boltpakker for / Boltpack-		Sign. _____
	VK95 L=3235 4 600-2635 00-400-009 VK95 L=1300 2 01-129-006 VK95L=640 2 01-126-005	Gulv 1 1160x1160x15 00-400-300
	Stolpe med HPL 1 600-2435=3035 00-400-016	Stolpe med HPL 1 600-2435=3035 00-400-017
	Ribbevegg rør 5 00-400-149	Sperrerør med beslag 1 00-400-150
	Vegg 4 940x686x12 01-125-002	Ende lokk 10 00-400-998
	Sprosse gulv 4 1130x145x15 01-400-108	Sprosse Ribbevegg 1 1130x145x15 01-400-102
	Sperrerør portal 1 01-126-004	Frontplate portal 2 01-126-003
	Sideplate portal 1 Høyre 01-126-001	Side plate portal 1 Venstre 01-126-002
	N-nett 1 05-156-003	

Boltepakker for / Boltpackage for / Bultpaket för			Sign. _____.
	Tak 01-128-001	2	Gavel 01-128-002
	Ligger N-nett 00-400-801 Med 4 hull	1	Ligger 00-400-799
	Systembane 1400 40-142-101	1	Fundament- plate 3H 80 00-003-106
	Trapp 1400 01-129-084	1	Trapp vange 01-129-004
	Trapp Vange 01-129-005	2	
			Eventuelt Fundamenter
			

Boltepakker for / Boltpackage for / Bultpaket för			Sign. _____.		
	Torx M8x12 04-000-012	24		Brikke 50-1T 04-060-050	20
	Torx M8x16 04-000-016	6		Brikke 120-3T 04-060-120	24
	Torx M8x25 04-000-025	48		Brikke 160-3T 04-060-160	4
	Torx M8x35 04-000-035	72			
	Torx M8x45 04-000-045	4			
	Vinkel 35x35x35 04-070-036	13		Stålforankring 00-100-312	2
	Vinkel 50x50x50 04-075-050	16			
	Møbelknapp M8x13x17 04-030-011	30		Hylsemutter M8 12-38 04-018-060	2
				Produktmerking Montert hos Søve	
	Plast plug 9-11mm 04-090-002	24		Plug spor 00-400-980	8
	Skive M8 04-050-008	40		Låsemutter M8 04-040-008	30