

**(N) Monteringsanvisning**

**(UK) Assembly Instructions**

**(S) Monteringsanvisning**

Produkt nr. / Product no. / Produkt nr.

**11-145-153**

Ordr. nr. \_\_\_\_\_

Dato. \_\_\_\_\_

Sign. \_\_\_\_\_



**Søve Lekemiljø AS**

3830 Ulefoss - Norway

Tlf: +47 35 94 65 65

[www.sove.no](http://www.sove.no)



**Søve AB**

412 50 Göteborg

Phone: +46 (0)31 773 97100

[www.sove.se](http://www.sove.se)

21.12.2011

**1**

# Monteringstips / Assembly Advice / Monteringsstips

**N**

- ▣ Les monteringsanvisningen nøye før montering.
  - ▣ Monter elementene i rekkefølgen som vist.
  - ▣ Boltene bør ikke skrues for hardt til før alt er montert, vatret og loddet. Skru så boltene til.
- NB! Ved bruk av drill, kan boltene ryke.
- ▣ På grunn av at solen kan gjøre rutsjeflaten veldig varm, bør rutsjebanens utløp vende mot nord-øst eller nord-vest.
  - ▣ Er lekeutstyret plassert i naturlige ferdselstraséer må området sikres mot spontan gjennomgang.
  - ▣ Innspringningshinder bør vurderes rundt lekeapparater hvor det er stor bevegelse, f.eks. ved huskestativ.
  - ▣ Det bør være fritt innsyn til lekeutstyr som er beregnet for barn under 3 år.

**NB! Under monteringsarbeidet må utstyr, som ikke er forankret forsvarlig i bakken, avstives slik at det ikke velte. Området må avstenges under oppsettelse av apparatene med sperrebånd eller lignende.**

**UK**

- ▣ Read the instruction carefully before assembling the play unit.
  - ▣ Assemble the components in the sequence shown in these instructions.
  - ▣ Fixings must not be fully tightened during assembly. Before casting the foundations, the structure must be level and plumb, at which point all fixings are tightened.
- PS! If use of drill, the bolts may be wrecked.
- ▣ Avoid positioning the slide facing due south because of overheating – ideal positions are facing north-east or north-west.
  - ▣ Secure the construction-area to prevent people from walking through it.
  - ▣ Consider installing barriers around play-equipment which gives rise to a lot of activity – i.e. swings.
  - ▣ Ensure that clear vision is possible across the play area so that supervision is possible from any position, particularly where children under 3 years of age will be playing.

**NB! During assembly of the equipment, ensure that all structures are securely propped, especially when left overnight. Also ensure that equipment is supported whilst concrete foundations are setting and enclose the area securely to prevent access.**

▮ Läs monteringsanvisningen noga före montering.

▮ Montera delarna i den ordningen som anvisas

▮ Skruvarna bör inte skruvas för hårt tills allt är monterat, i våg och lodat.

**OBS!** Används elektrisk skruvdragare, kan bulten gå sönder. Hårdra därför manuellt!

▮ Solen kan göra att rutchbanan blir väldigt varm. Banans nedfart rekommenderas att vändas i norrlig riktning

▮ Om lekplatsen placeras vid en gångväg mm bör området säkras mot genomfart av gående och cyklister.

▮ Inspringningshinder bör placeras runt lekutrustning med stor rörelse, t ex, gungställning.

▮ Det bör vara fri insyn till lekutrustning beräknat till barn under 3 år.

**OBS! Under monteringsarbete bör utrustningen som inte ska förankras i marken, ställs så att den inte kan välta.**

**Området måste spärras när lekutrustningen byggs upp, med avspärrningsband eller liknande.**

2

Nødvendig verktøy / Tools required / Nödvändiga verktyg

N  
UK  
S

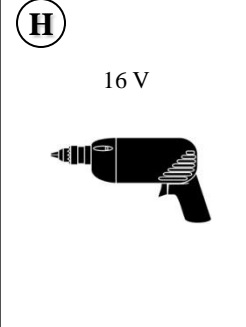
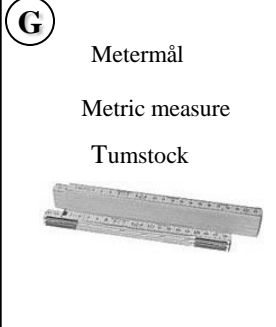
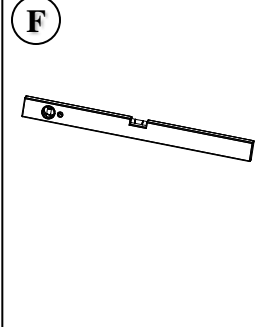
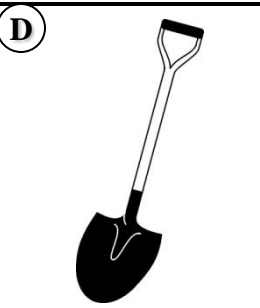
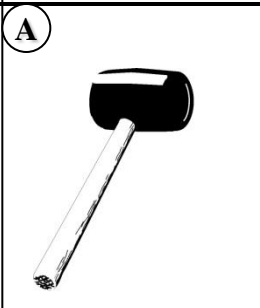

3

Nødvendig antall personer / Number of persons required / Lämpligt antal personer

N  
UK  
S





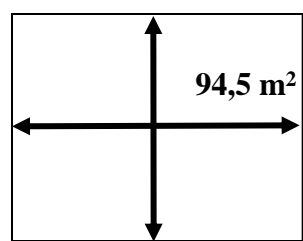

4

Anbefalt arealbehov ved montering / Recommended working space / Rekommenderad arealbehov vid montering

N  
UK  
S



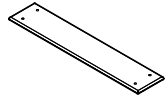
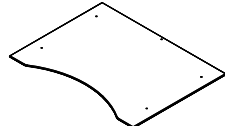
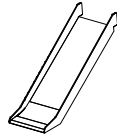
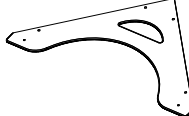
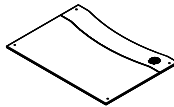
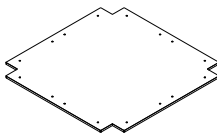

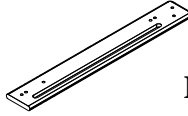
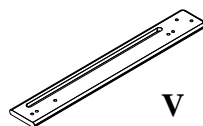
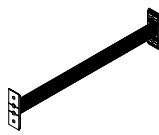
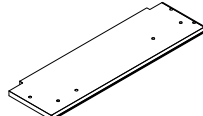
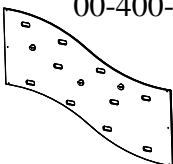
(N)  
(UK)  
(S)

Komponenter Components Komponenter	Dimensjon Dimension Dimension	Ant Qty Ant	Lev Lev Lev	Komponenter Components Komponenter	Dimensjon Dimension Dimension	Ant Qty Ant	Lev Lev Lev
00-400-015 	3235 x 95x 95 Med 2 brikker i hver stolpe	4		01-126-004 	904 x 61 x 37	1	
00-400-032	3235 x 95x 95	1					
00-400-033	2300 x 95 x 95	1					
01-126-005	640 x 95 x 95	2		00-100-310 	512 x120	2	
00-400-101 	1130 x 145 x 15	4		01-128-001 	1280 x 960 x 12	2	
40-142-101 	0,5m x 3m	1		01-128-002 	1216 x 668 x 12	2	
01-125-001 	940 x 686 x 12	3		00-400-300 	1160 x 1160 x 15	1	
00-400-821 	1988 x 150 x 60	1		05-156-003 	1560 x 2980	1	
01-126-001 	750 x 107,5 x 18	1		N-nett			
01-126-002 	750 x 107,5 x 18	1		00-400-150 	940 x 120 x 40	1	
01-126-003 	674 x 205 x 18	2		00-400-735 	2930 x 1686 x 15	1	5

5

**Pakkliste for / Parts list for / Packlista för :**  
**11-145-153**

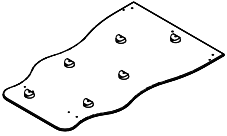
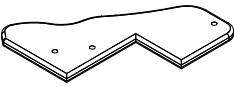

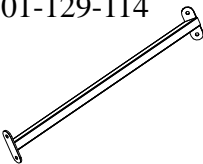
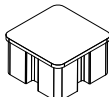

Sign. \_\_\_\_\_

(N) (UK) (S)	Komponenter	Dimensjon	Ant	Lev	Komponenter	Dimensjon	Ant	Lev
	Components	Dimension	Qty	Lev	Components	Dimension	Qty	Lev
	Komponenter	Dimension	Ant	Lev	Komponenter	Dimension	Ant	Lev
	01-129-112 	1480 x 910 x 15	1		(N) Produkt merking (UK) Product marking (S) Produkt märkning		1	
	01-129-113 	282 x 263 x 15	2					
	00-261-500 	940 x 120	1					
	04-080-004 	910 x 40 x 33	1					
	01-129-114 	810 x 120 x 40	2					
	00-400-998 	55 x 95 x 95	8					
	00-400-997 Med hull	55 x 95 x 95	6					



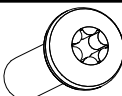
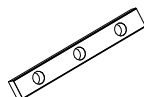







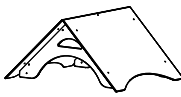

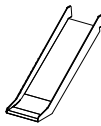

5

**Pakkliste for / Parts list for / Packlista för :  
11-145-153**



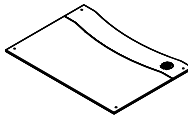







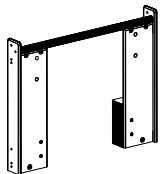

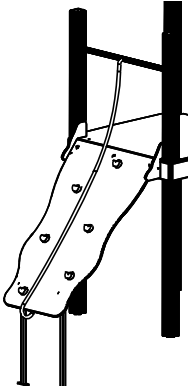





Sign. \_\_\_\_\_

N UK S	Bolter/skruer Bolts/Screws Komponenter	Dimensjon Dimension Dimension	Ant Qty Ant	Lev Lev	Bolter/skruer Bolts/Screws Bultar/Skruvar	Dimensjon Dimension Dimension	Ant Qty Ant	Lev Lev
		04-000-025 8 x 25 mm Torx	12				04-060-040 40 x 15 x 8 mm	6
	04-000-035 8 x 35 mm Torx	22			04-060-120 120 x 15 x 8 mm		2	
		00-400-980	4			04-060-160 160 x 15 x 8 mm	2	
		04-040-008 8 mm	4			04-090-002	26	

**Boltepakker for / Boltpackage for / Bultpaket för 11-145-153**

01-128-000 		04-060-040 40 x 15 x 8 mm	4					
		04-000-012 8 x 12 mm Torx	22					
		04-000-035 8 x 35 mm Torx	4					
		04-070-035 35 x 35 x 3 mm	11					
		04-030-011 8 x 11 mm	22					
Antall Number Antal		04-050-008 8 mm	22					
40-142-101 		04-060-160 160 x 15 x 8 mm	2					
		04-000-035 8 x 35 mm Torx	4					
		04-000-045 8 x 45 mm Torx	2					
		04-040-008 8 mm	2					
Antall Number Antal	Monteringsanvisning Assembly Instructions Monteringsanvisning		1					
01-125-001 		04-060-040 40 x 15 x 8 mm	4	X 3				
		04-000-025 8 x 25 mm Torx	8	X 3				
		04-076-050 50 x 50 x 5 mm	4	X 3				
	Antall Number Antal			4	X 3			

**Boltepakker for / Boltpackage for / Bultpaket för 11-145-153**

<p>01-400-220</p> 	 <p>04-060-120 120 x 15 x 8 mm</p>	8	<p>01-129-010</p> 	 <p>04-060-120 120 x 15 x 8 mm</p>	2	
	<p>04-000-012 8 x 12 mm Torx</p>	2		 <p>04-060-040 40 x 15 x 8 mm</p>	2	
	<p>04-000-016 8 x 16 mm Torx</p>	6		 <p>04-000-025 8 x 25 mm Torx</p>	5	
	 <p>04-000-035 8 x 35 mm Torx</p>	16			 <p>04-000-030 8 x 30 mm Torx</p>	8
	<p>04-000-045 8 x 45 mm Torx</p>	2			<p>04-000-035 8 x 35 mm Torx</p>	4
	 <p>04-090-001 8 mm</p>	2			<p>04-000-040 8 x 40 mm Torx</p>	3
	 <p>04-070-035 35 x 35 x 3 mm</p>	2		<p>04-000-045 8 x 45 mm Torx</p>	2	
	 <p>04-030-011 8 x 11mm</p>	8		 <p>04-040-008 8 mm</p>	9	
	 <p>04-050-008 8 mm</p>	4		 <p>04-070-035 35 x 35 x 3 mm</p>	2	
	 <p>04-090-002</p>	4		 <p>04-030-016 8 x 16 mm</p>	3	
	<p>Monteringsanvisning Assembly Instructions Monteringsanvisning</p>				 <p>04-050-008 8 mm</p>	9
	<p>Antall Number Antal</p>	01-400-220		1	 <p>04-090-001</p>	2





**6****Fundamentering med betong / Foundation concrete / Förankring med betong**

(N) Bakkenivå (UK) Ground level (S) Marknivå

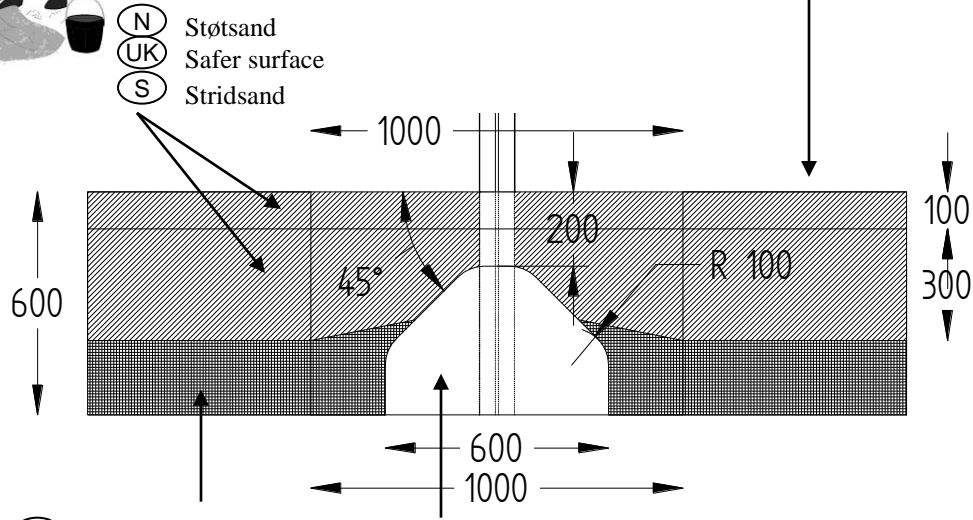

(N) Komprimert masse.      betong  
 (UK) Compressed mass.      concrete  
 (S) Komprimerad massa.      betong

**6****Fundamentering uten betong / Foundation without concrete / Förankring utan betong**

(N) Bakkenivå (UK) Ground level (S) Marknivå

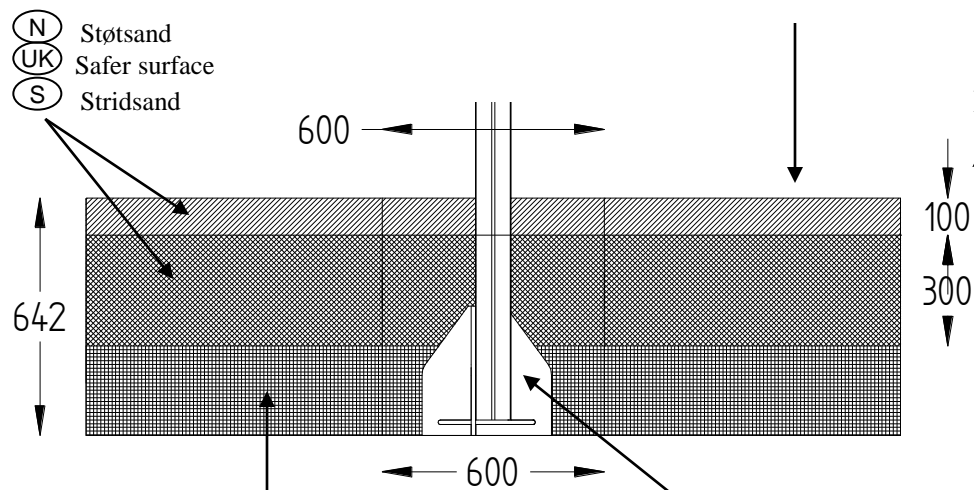

(N) Støtsand  
 (UK) Safer surface  
 (S) Stridsand

(N) Komprimert masse      Støpefri nedgraving  
 (UK) Compressed mass      Concrete-free anchor  
 (S) Komprimerad massa      Nedgravningsfundament

(N)

Alle mål er oppgitt i millimeter

(UK)

Scale measured in mm

(S)

Alla mått är i millimeter.

6

Fundamentering med betong / Foundation concrete / Förankring med betong



(N) Bakkenivå (UK) Ground level (S) Marknivå

(N) Støtsand  
(UK) Safer surface  
(S) Stridsand

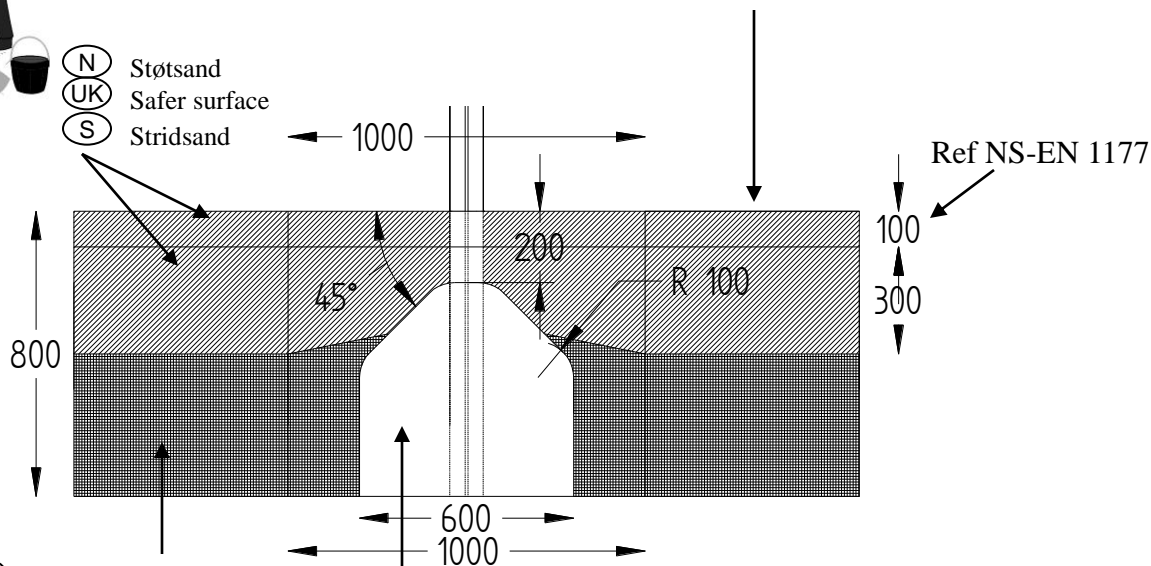

(N) Komprimert masse. betong  
(UK) Compressed mass. concrete  
(S) Komprimerad massa. betong

6

Fundamentering uten betong / Foundation without concrete / Förankring utan betong

(N) Bakkenivå (UK) Ground level (S) Marknivå

(N) Støtsand  
(UK) Safer surface  
(S) Stridsand

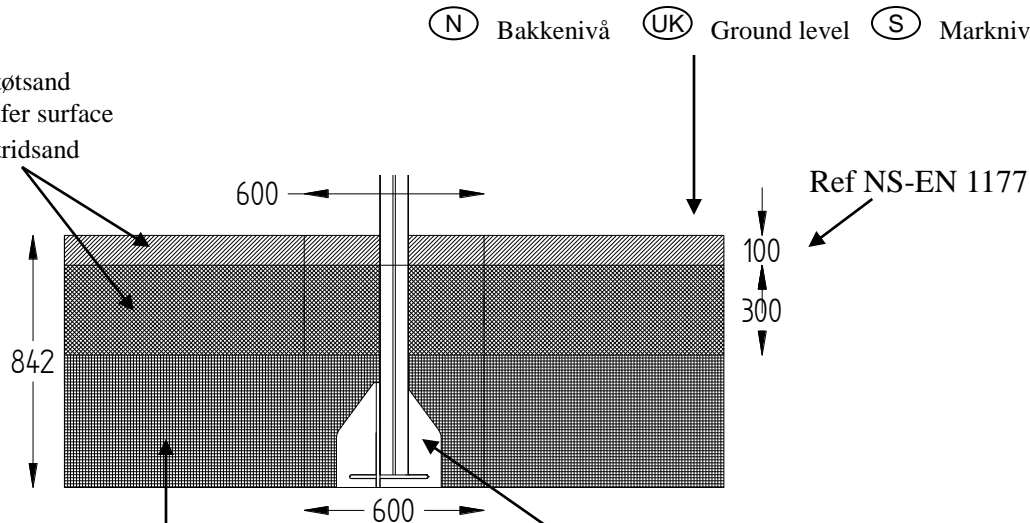

(N) Komprimert masse Støpefri nedgraving  
(UK) Compressed mass Concrete-free anchor  
(S) Komprimerad massa Nedgravningsfundament

(N) Alle mål er oppgitt i millimeter

(UK) Scale measured in mm

(S) Alla mått är i millimeter.

- (N) For klatrenett
- (UK) For climbing net
- (S) För klätternät

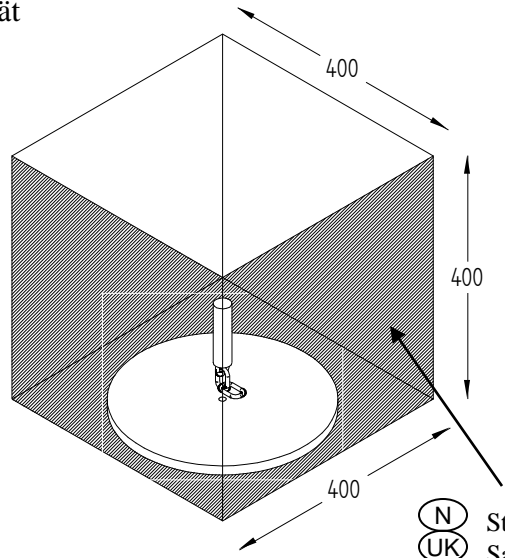
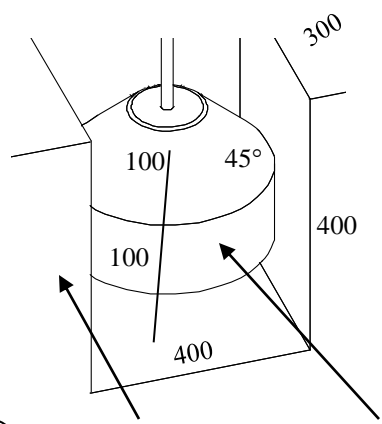

- (N) Komprimert masse.      betong
- (UK) Compressed mass.      concrete
- (S) Komprimerad massa.      betong

- (N) Støtsand
- (UK) Safer surface
- (S) Stridsand

- (N) Alle mål er oppgitt i millimeter
- (UK) Scale measured in mm
- (S) Alla mått är i millimeter.

# 6

(N) Dybde for støping og forankring

(UK) Depth of foundations /

(S) Djup för gjutning och markförankring

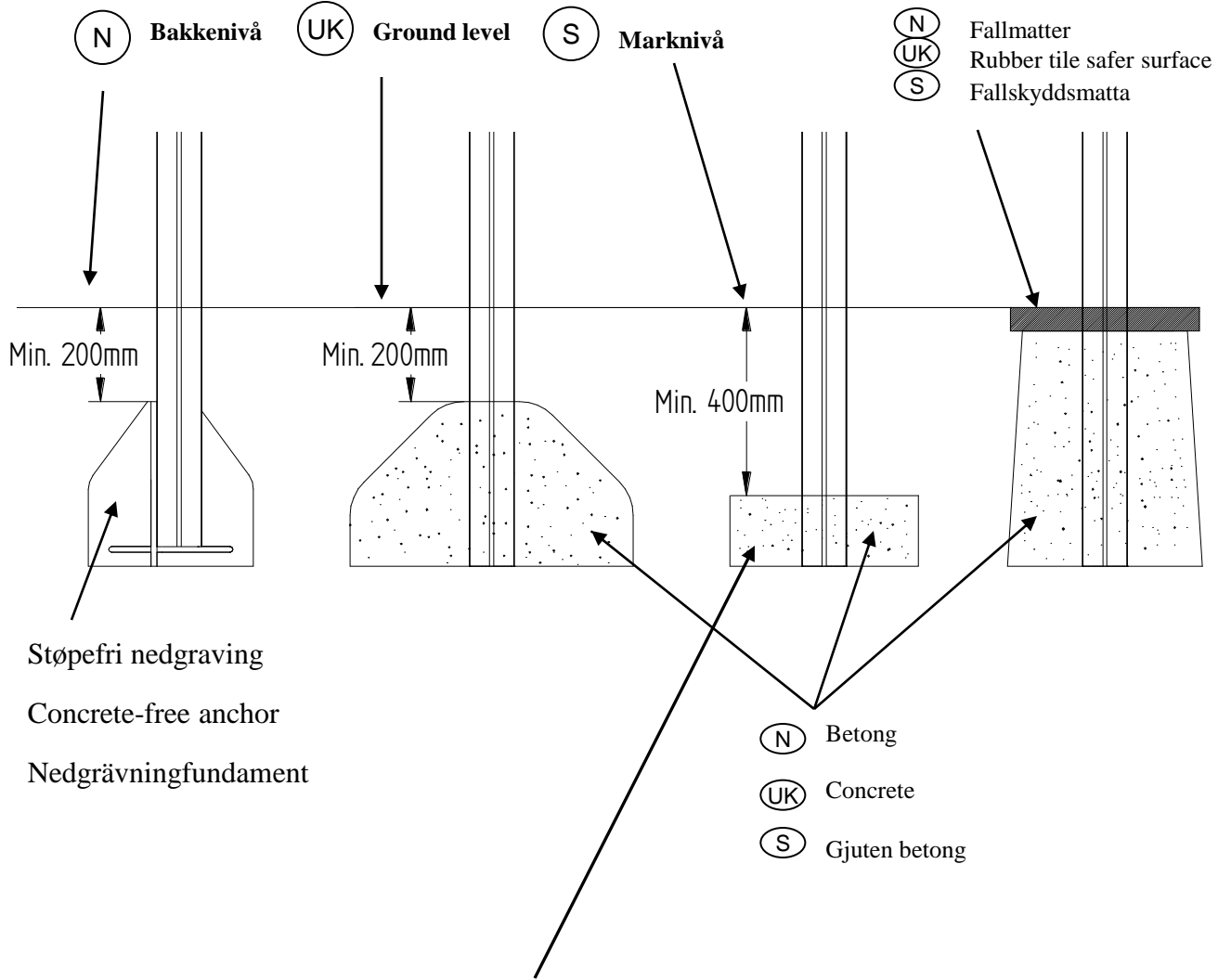

(N) Denne støpemetoden anbefales ikke grunnet dårlig stabilitet av lekeapparatet.

(UK) This anchor is recommend not to use because of poor stability of the play unit.

(S) Denna förankring avrådes från att användas, därför att lekutrustningen får dålig fäste.

1

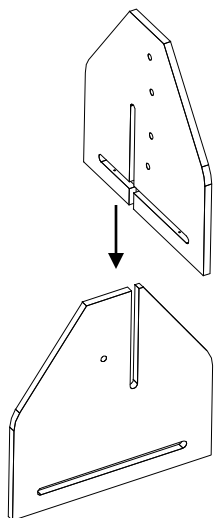

2

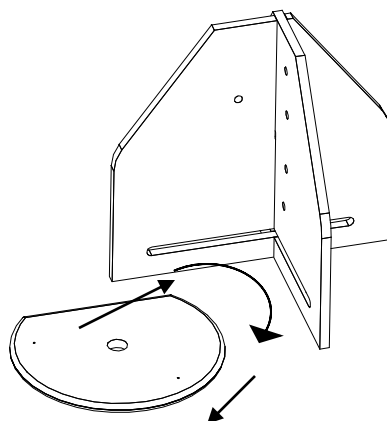

3

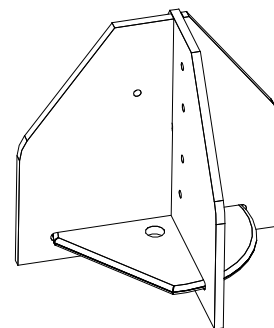

4

04-060-120 x 2  
120 x 15 x 8 mm

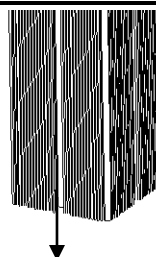

04-000-035 x 3  
8 x 35 mm Torx

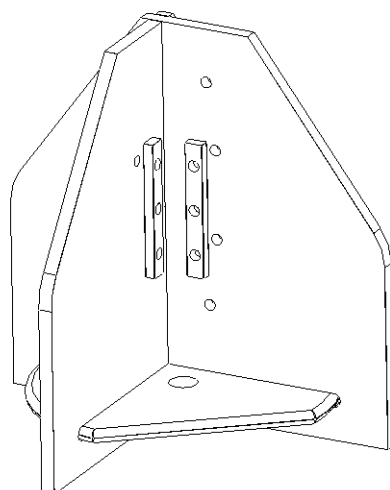

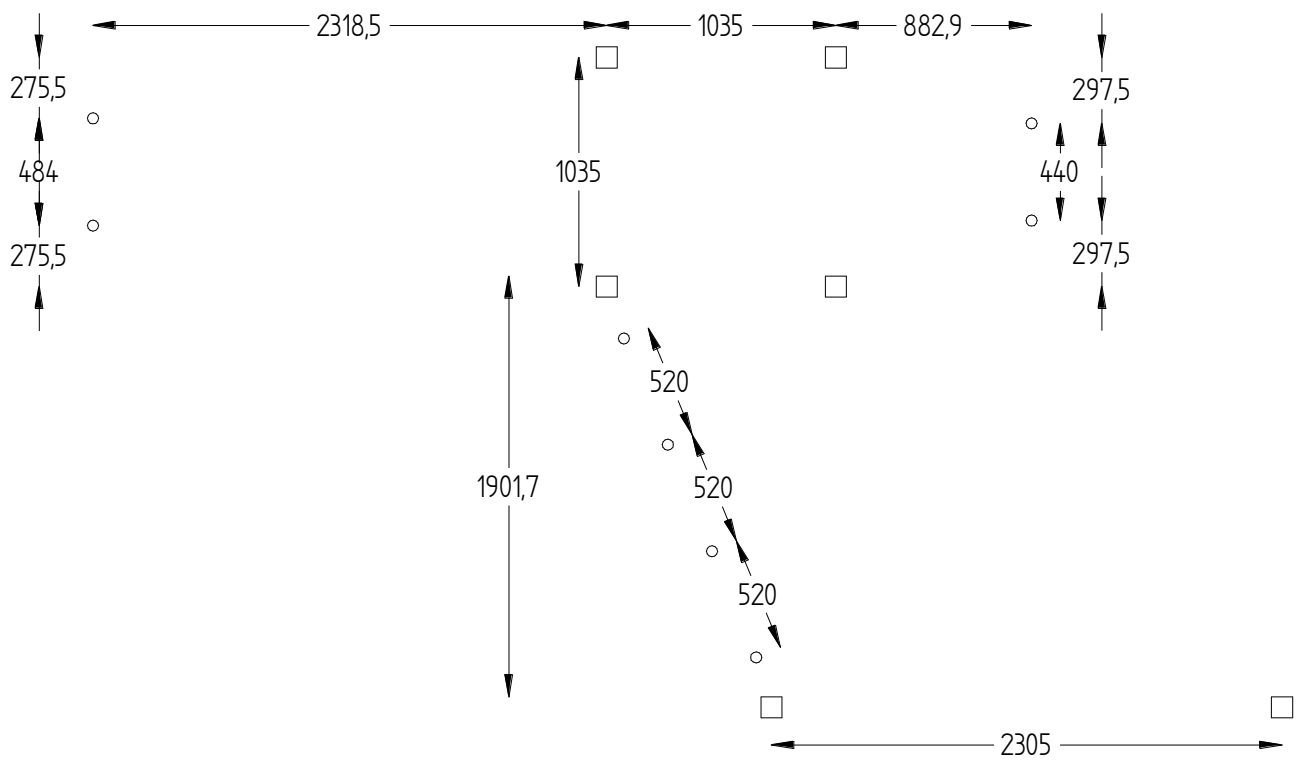

- (N) Alle mål er oppgitt i millimeter
- (UK) Scale measured in mm
- (S) Alla mått är i millimeter.

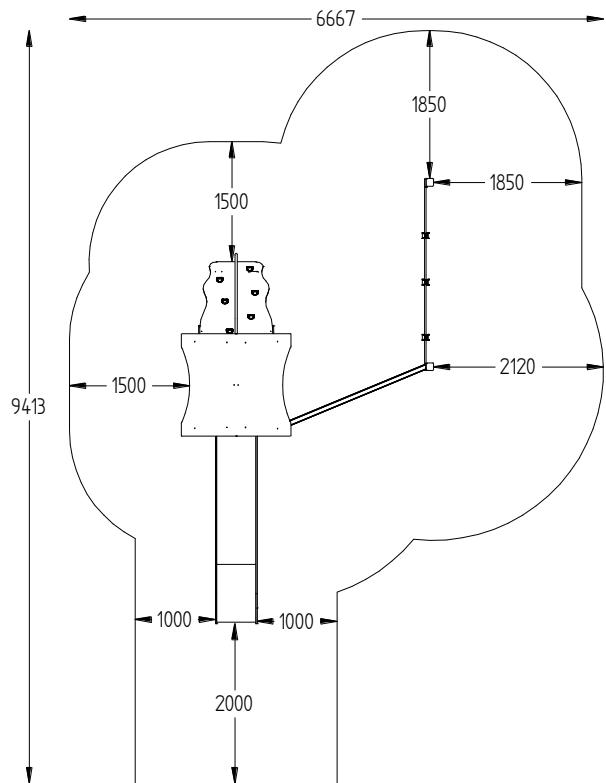
**7****Sikkerhetszone / Safety zone / Säkerhetszon****N**

Alle mål er oppgitt i millimeter

**UK**

Scale measured in mm

**S**

Alla mått är i millimeter.

**8****Fallhøyder / Free height of fall / Fallhöjder****N**

Alle mål er oppgitt i millimeter

**UK**

Scale measured in mm

**S**

Alla mått är i millimeter.



**OBS !**

- Ⓝ Bolter skrues helt igjennom aluminiumstolpene. Om elektrisk drill brukes anbefales 18 V
- ⓊⓀ Bolts must be tightened through the post, so that it pierces the aluminium.
- Ⓢ Bultarna skruvas rakt igenom aluminiumstolparna. Om elektrisk skruvdragare används rekommenderas 18 V

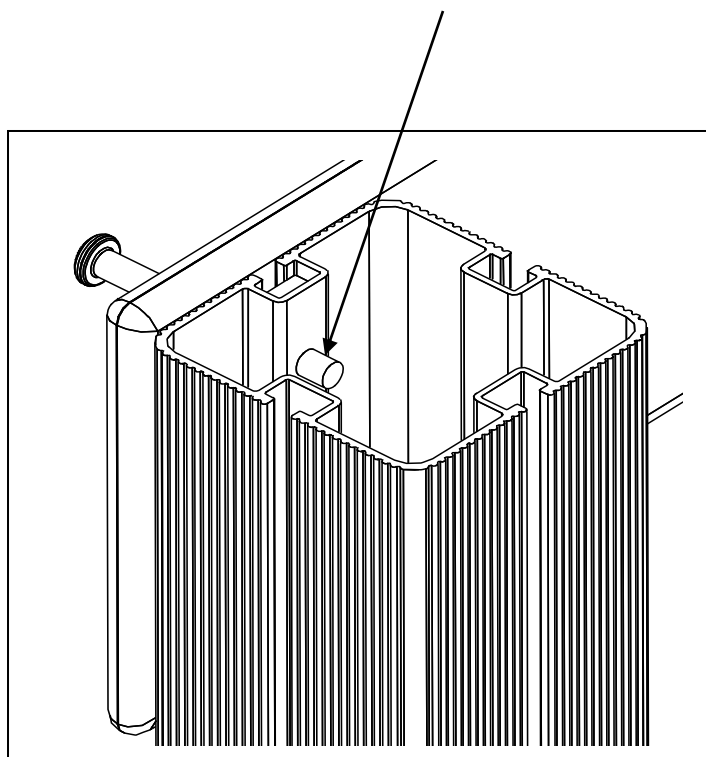

- (N) Uten betong
- (UK) Without concrete
- (S) Utan betong

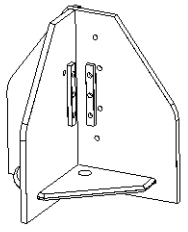

00-003-003

- (N) Med bruk av betong
- (UK) With use of concrete
- (S) Användning av betong

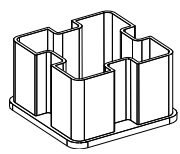
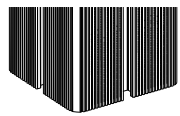

00-400-997

00-400-015 x 4

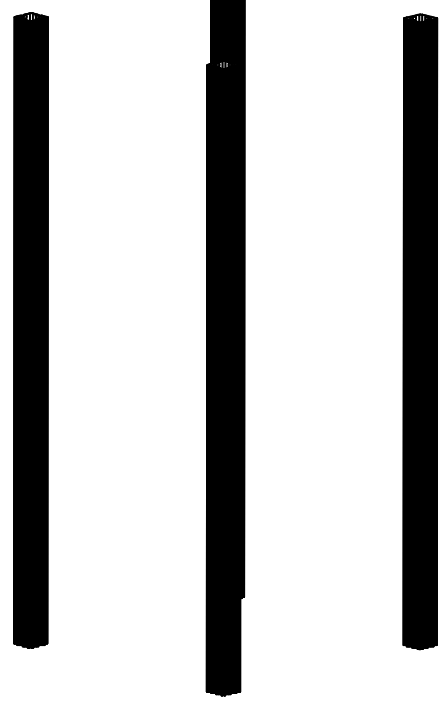

1

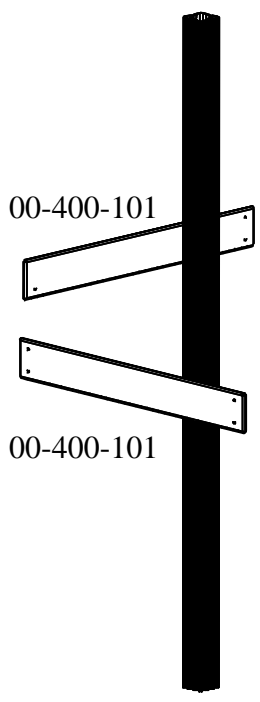

00-400-101

00-400-101

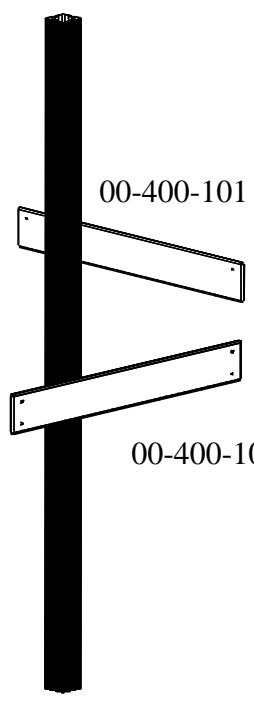

00-400-101

00-400-101

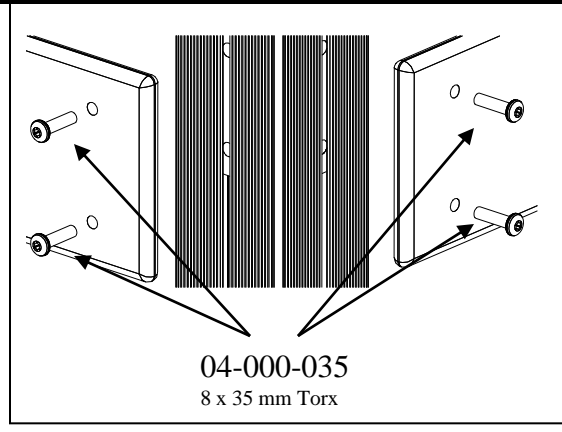

04-000-035  
8 x 35 mm Torx

2

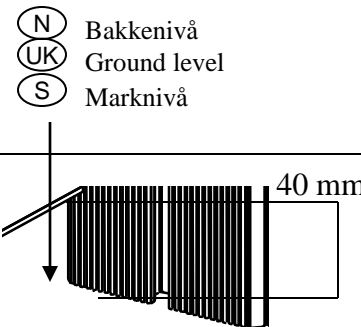
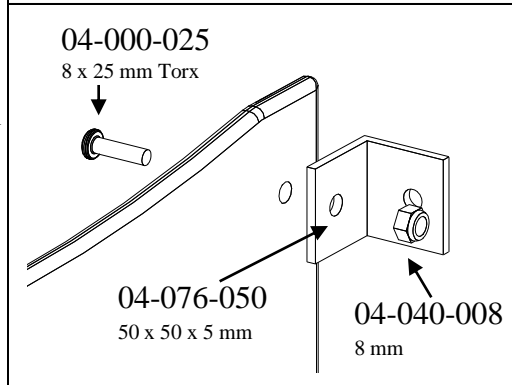
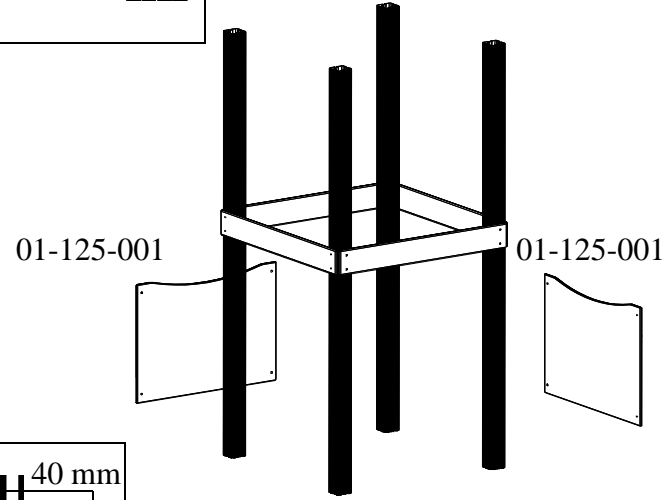
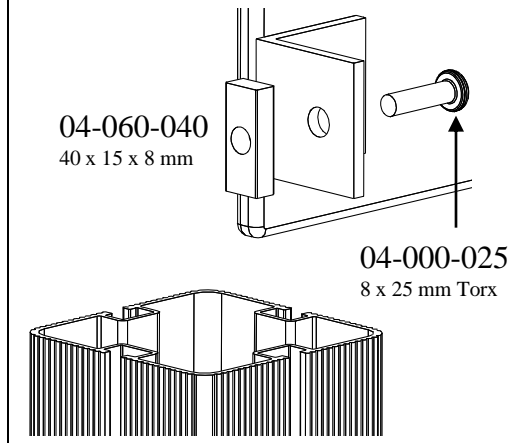
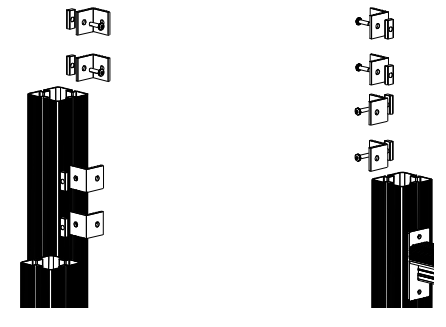

3

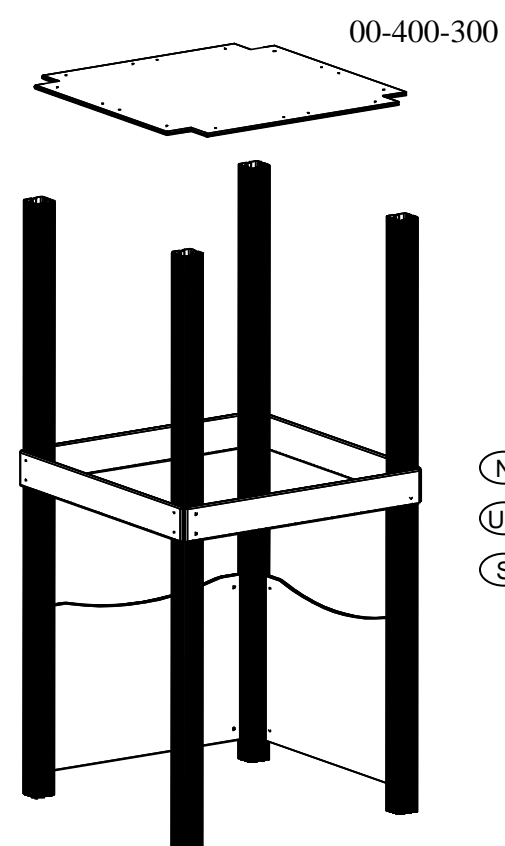

- (N) Gulvet festes ikke med vinkler
- (UK) The floor is not connected
- (S) Golvet fästes inte med vinklar

4

01-125-001

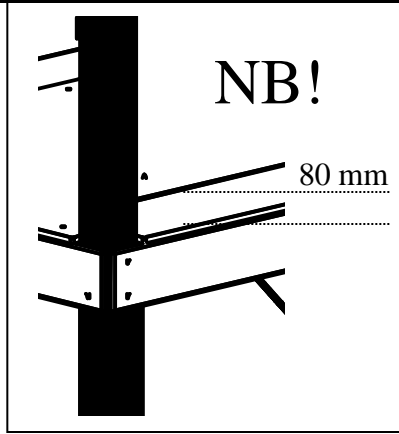
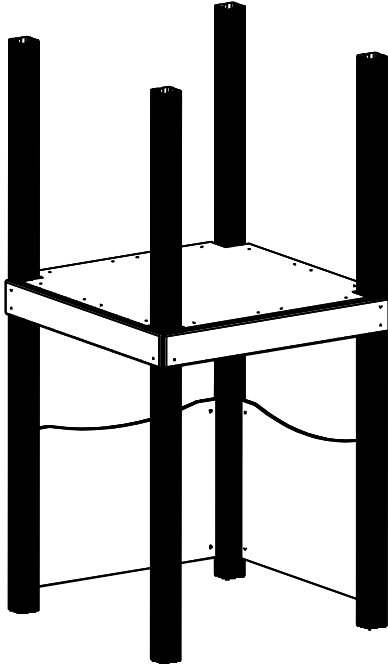
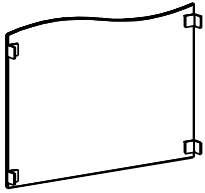

04-060-040  
40 x 15 x 8 mm

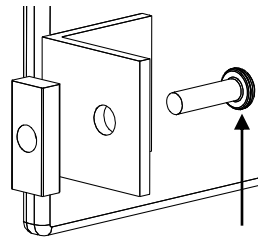

04-000-025  
8 x 25 mm Torx

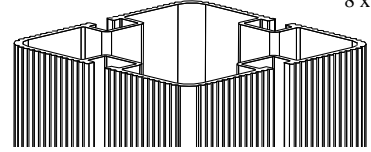

04-000-025  
8 x 25 mm Torx

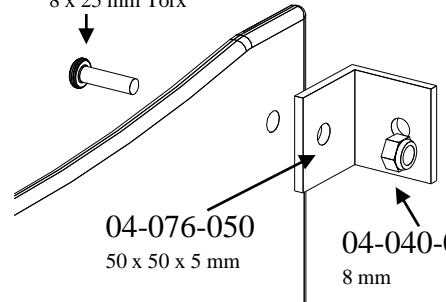

04-076-050  
50 x 50 x 5 mm

04-040-008  
8 mm

5

650

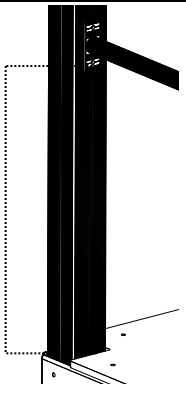

00-400-150

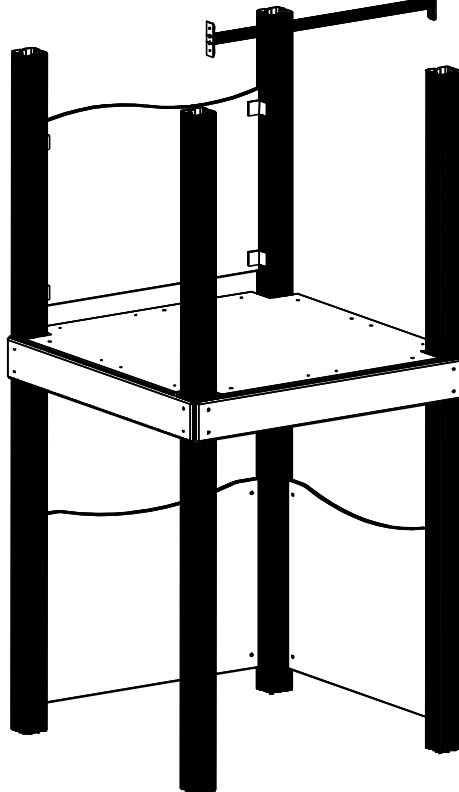

04-060-120  
120 x 15 x 8 mm

04-000-025  
8 x 25 mm Torx

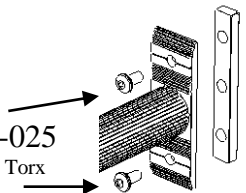

6

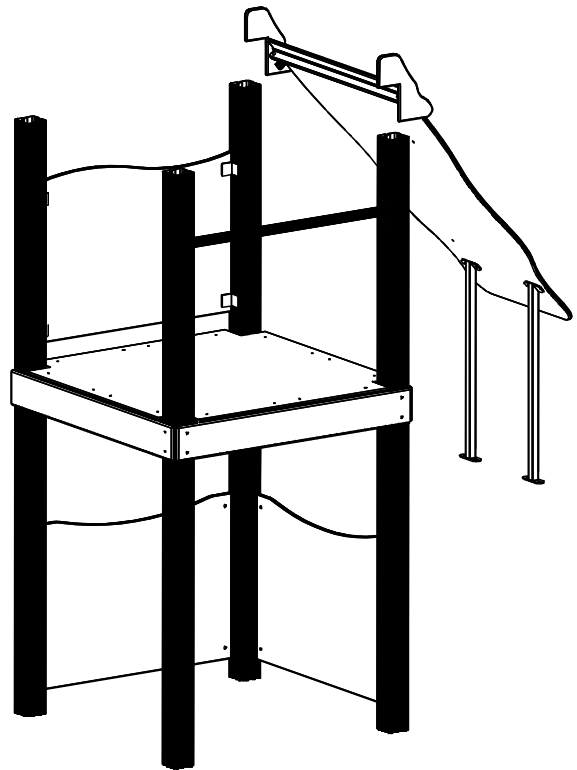

01-129-113

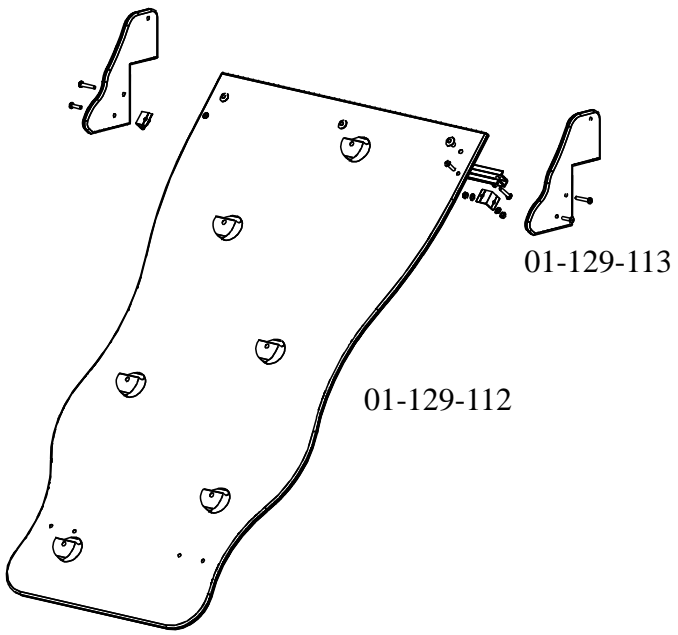

04-030-016  
8 x 16 mm

04-000-030  
8 x 30 mm Torx

04-080-004

04-090-001

04-000-040  
8 x 40 mm Torx

04-070-035  
35 x 35 x 3 mm

04-050-008  
8 mm

04-040-008  
8 mm

04-000-045  
8 x 45 mm Torx

04-000-030  
8 x 30 mm Torx

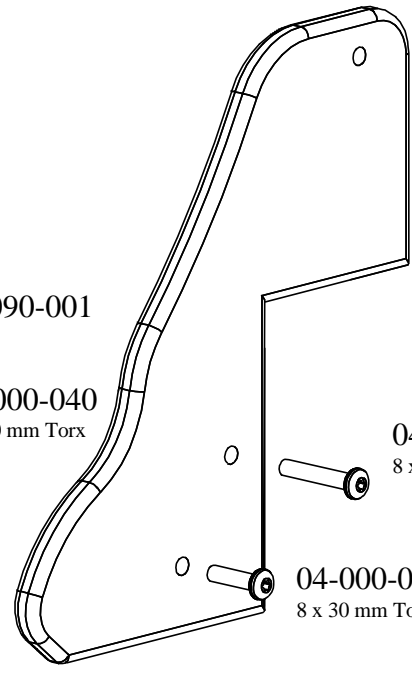

04-000-030  
8 x 30 mm Torx

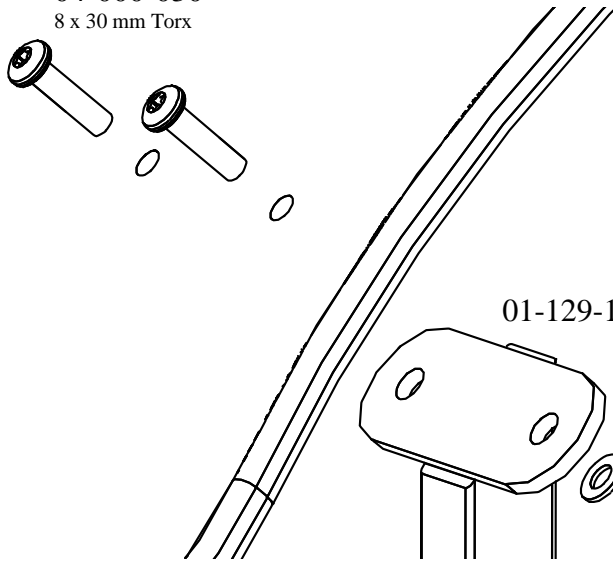

01-129-114

04-050-008  
8 mm

04-040-008  
8 mm

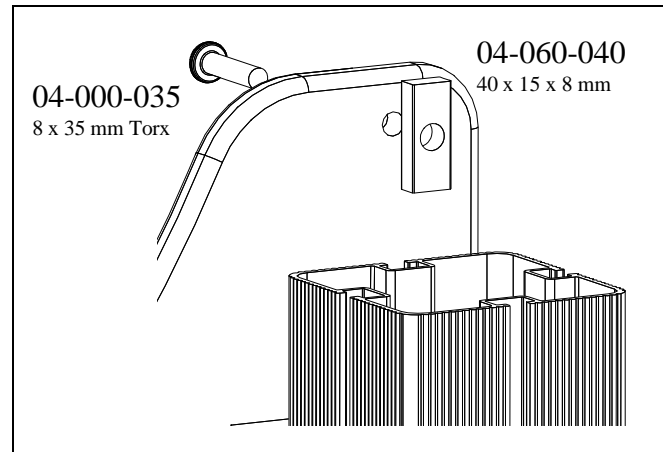
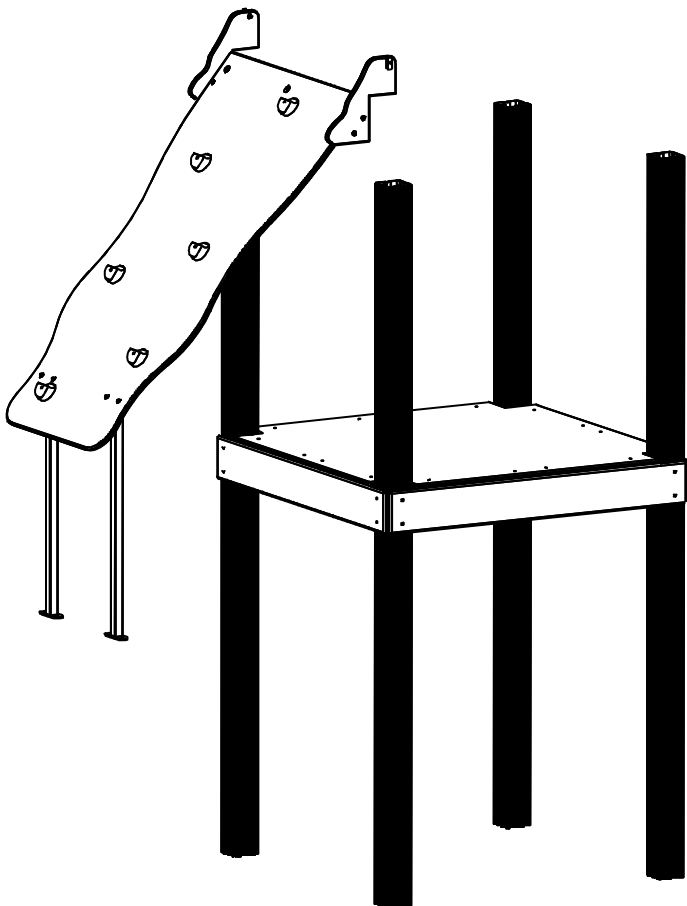

04-000-035  
8 x 35 mm Torx

04-060-040  
40 x 15 x 8 mm

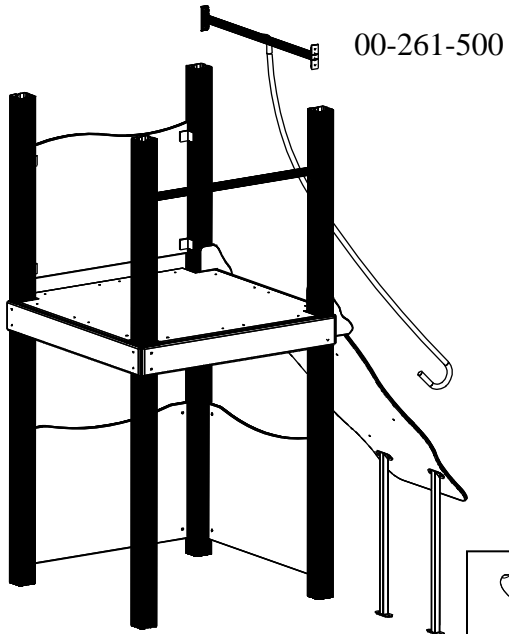

00-261-500

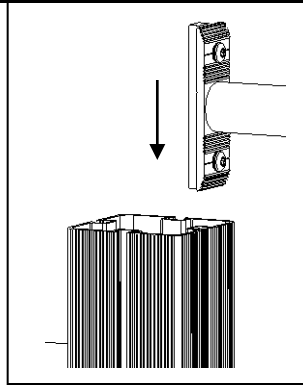

04-060-120  
120 x 15 x 8 mm

04-000-025  
8 x 25 mm Torx

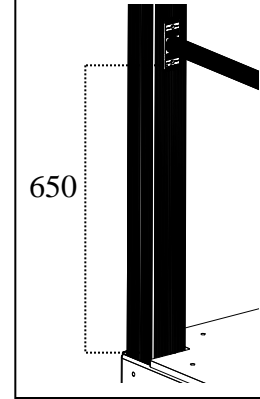

650

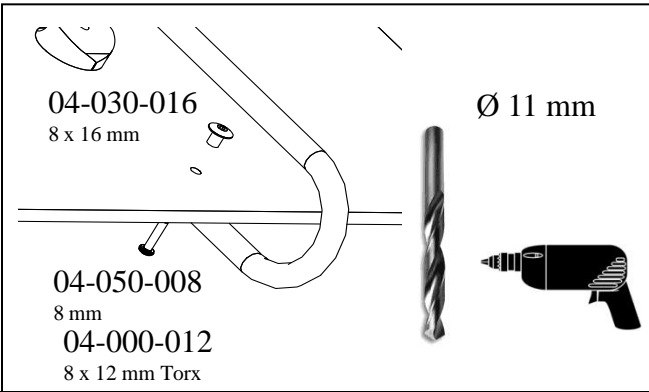

04-030-016  
8 x 16 mm

Ø 11 mm

04-050-008  
8 mm

04-000-012  
8 x 12 mm Torx

9

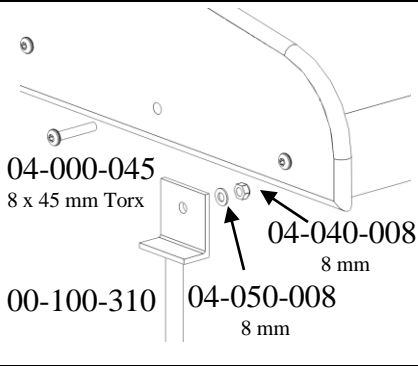

04-000-045  
8 x 45 mm Torx

04-040-008  
8 mm

00-100-310 04-050-008  
8 mm

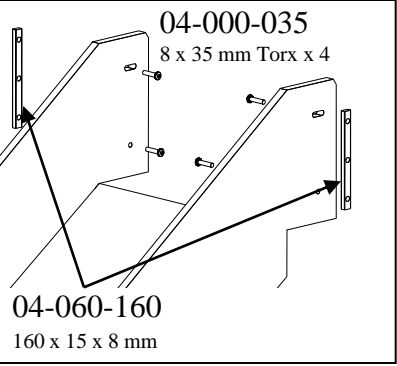

04-000-035  
8 x 35 mm Torx x 4

04-060-160  
160 x 15 x 8 mm

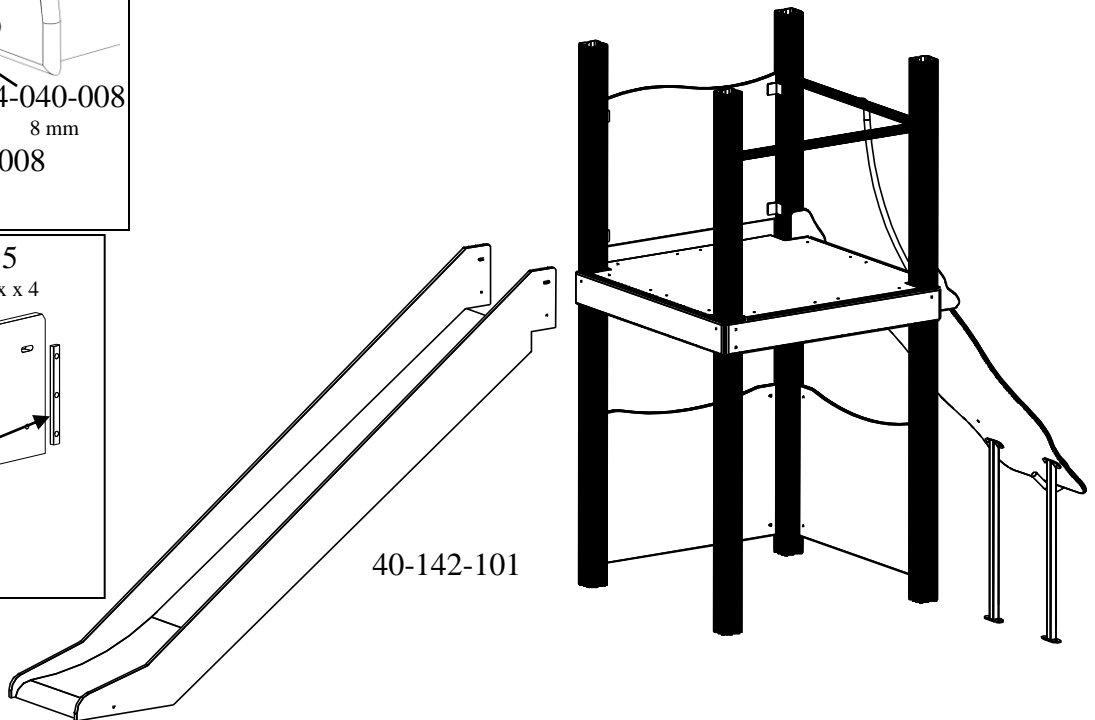

40-142-101

10

01-126-004

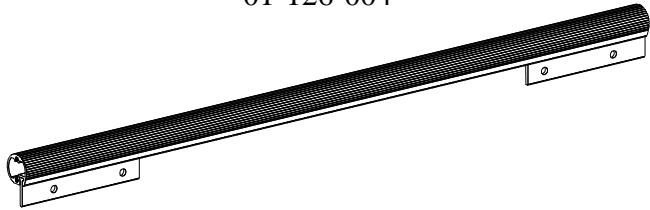

11

04-030-011  
8 x 11mm

04-030-011  
8 x 11mm



01-126-003

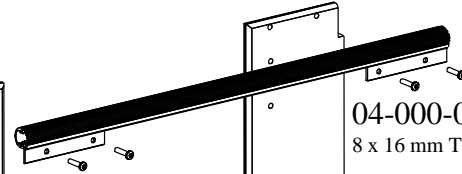

04-000-016  
8 x 16 mm Torx

04-000-016  
8 x 16 mm Torx

01-126-003

11

04-000-035  
8 x 35 mm Torx

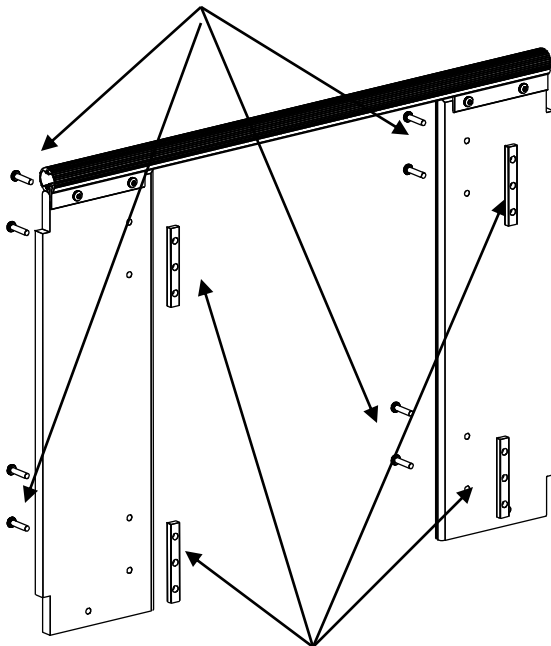

04-060-120  
120 x 15 x 8 mm

12

04-000-040  
8 x 40 mm Torx

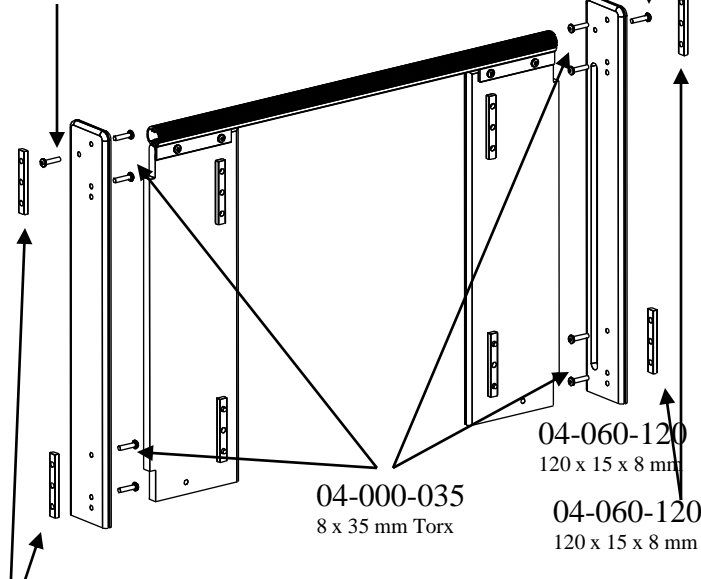

04-060-120  
120 x 15 x 8 mm

04-000-035  
8 x 35 mm Torx

04-000-040  
8 x 40 mm Torx

04-060-120  
120 x 15 x 8 mm

04-060-120  
120 x 15 x 8 mm

3



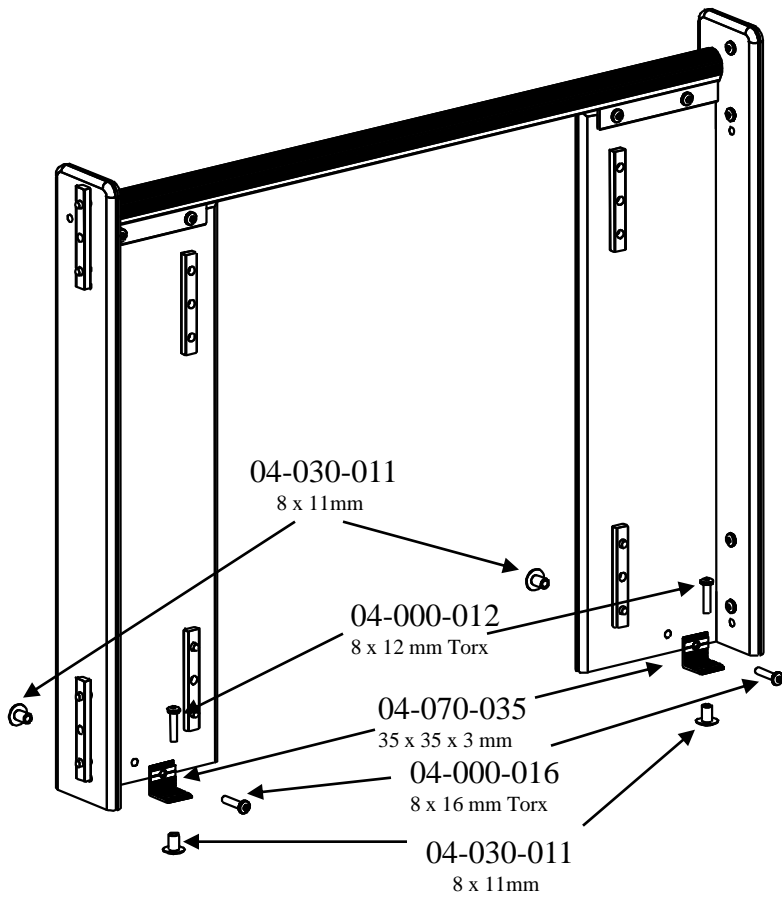

4

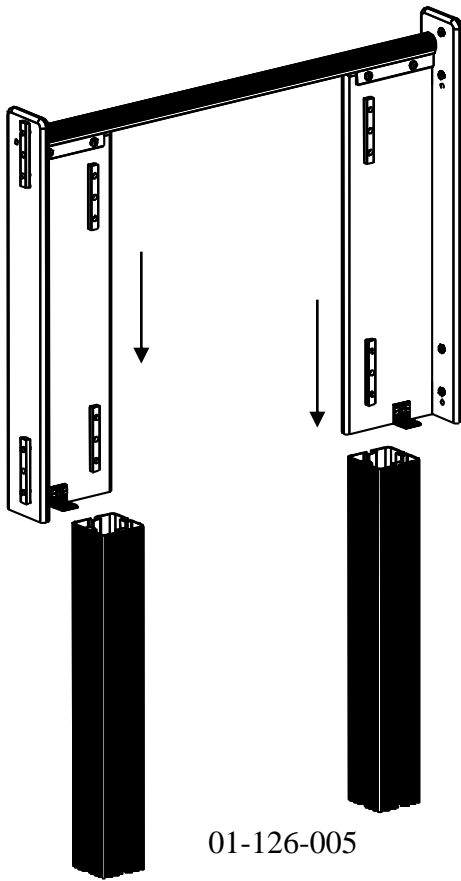

15

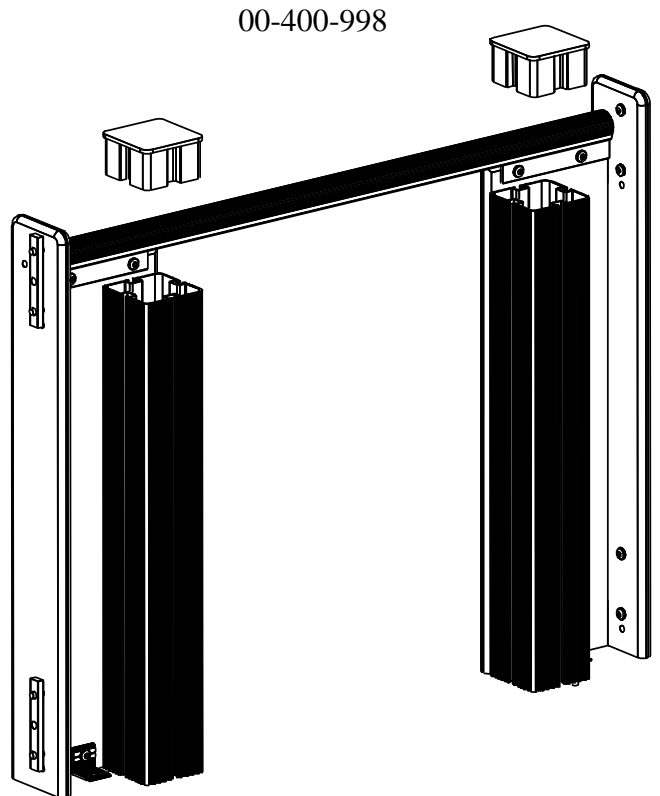

16

01-400-220

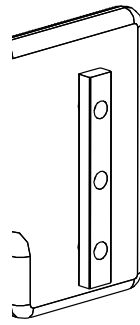
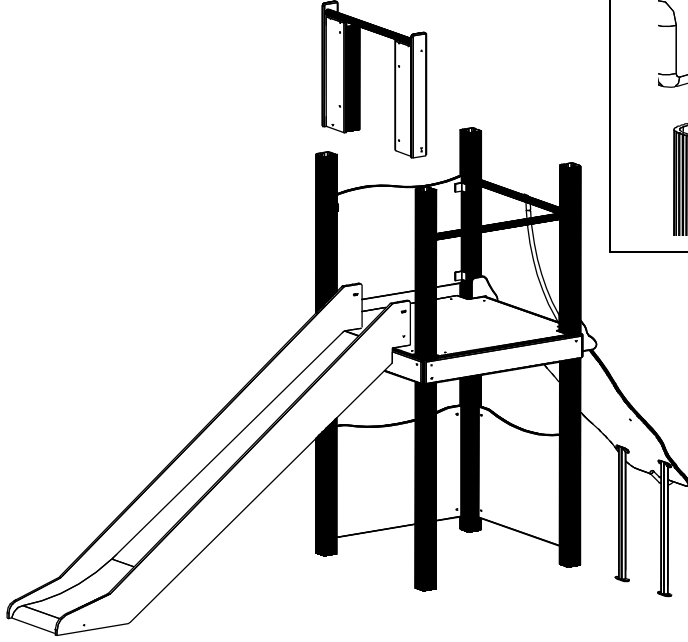

1

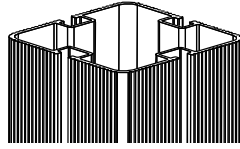

2

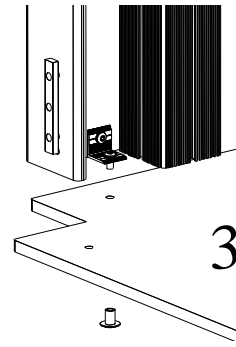
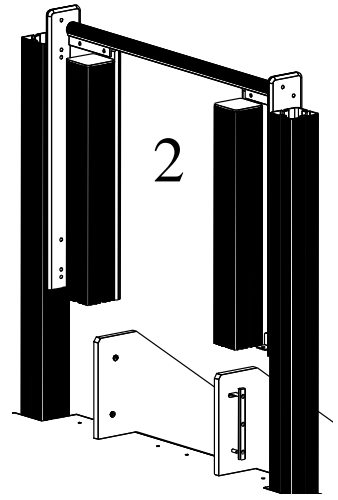

3

17

265 mm

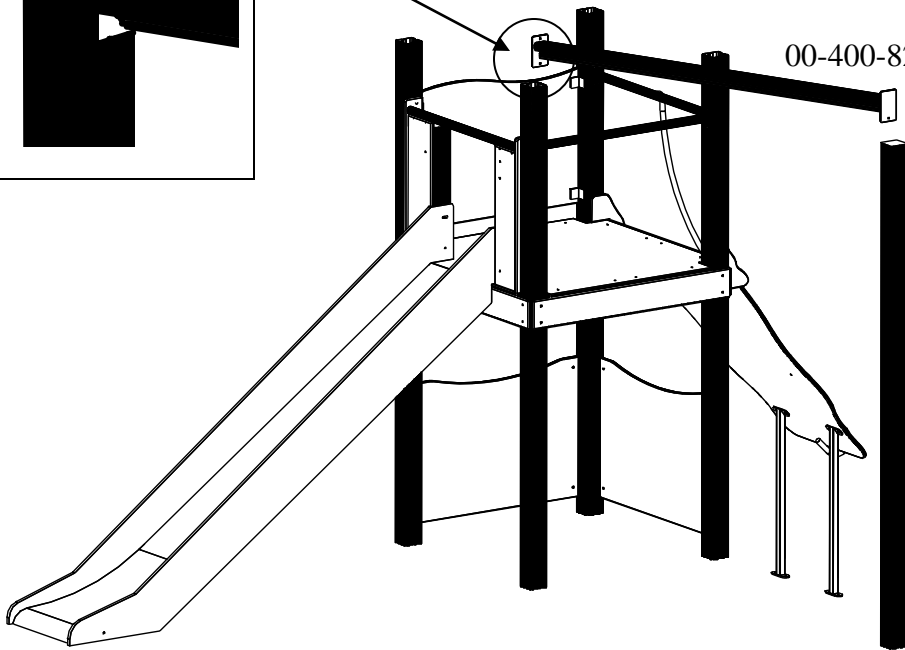
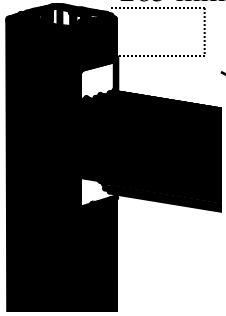

00-400-821

00-400-032

04-000-025  
8 x 25 mm Torx

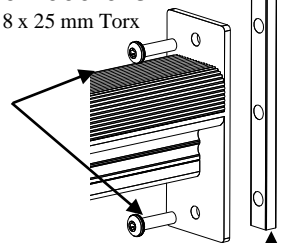

04-060-160  
160 x 15 x 8 mm

18

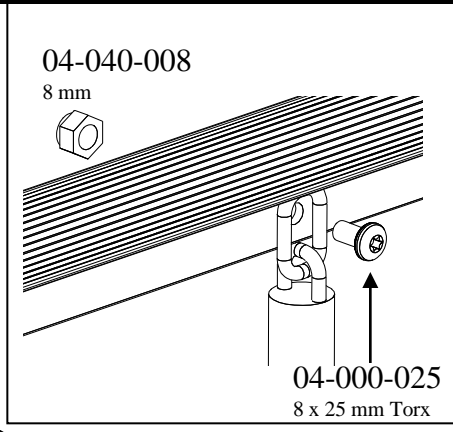
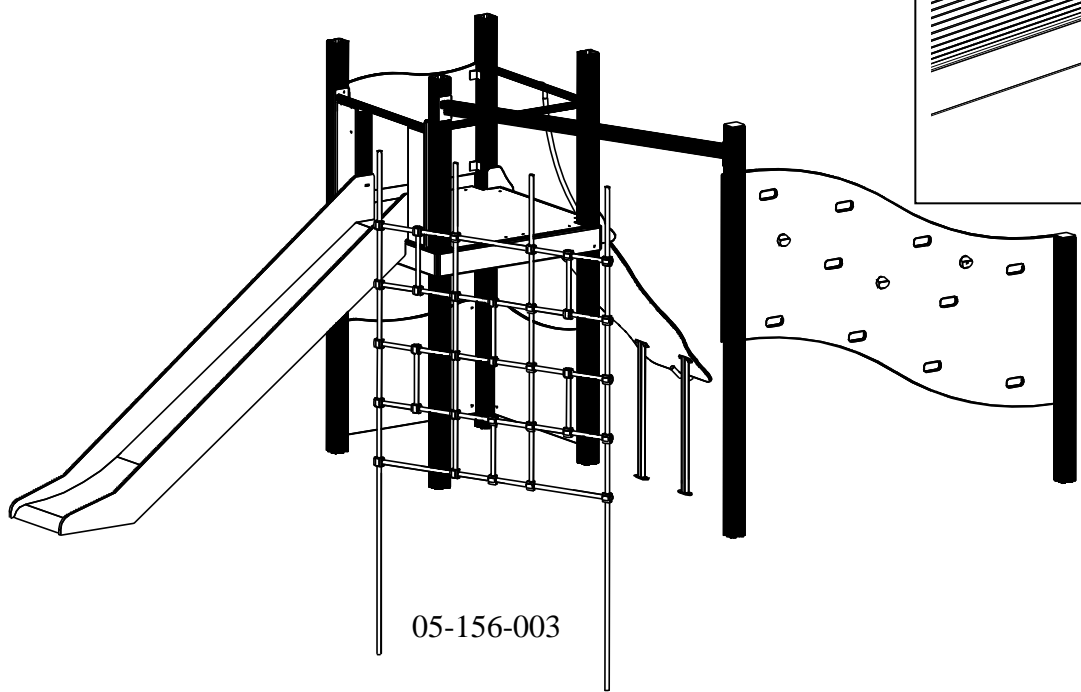
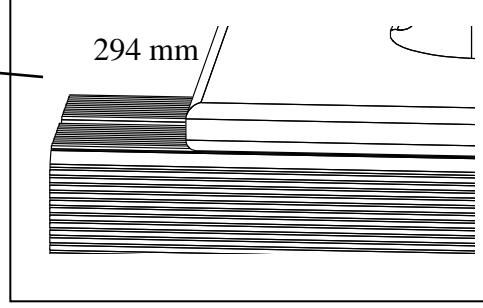
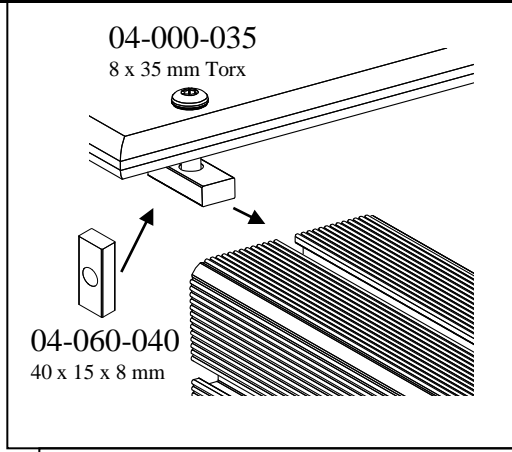
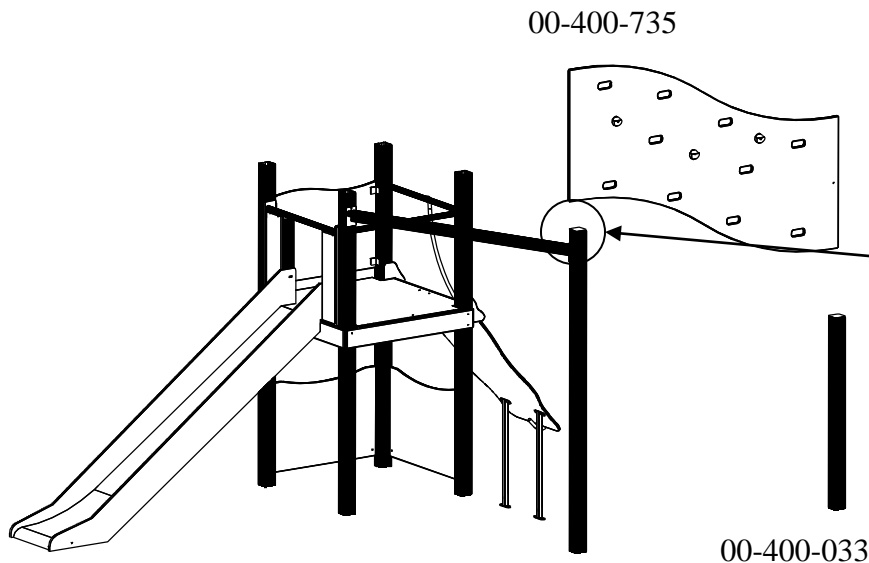

00-400-998



40 x 15 x 8



00-400-998

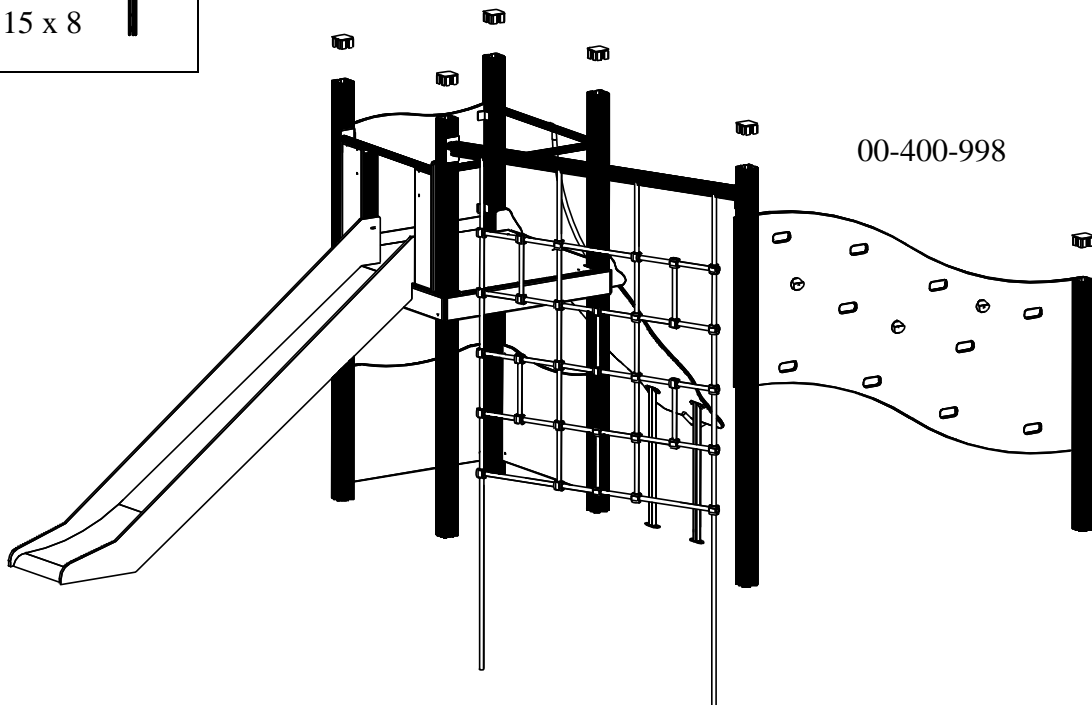

00-400-998

- (N) Se neste side for montering av taket
- (UK) See next page for assembly the roof
- (S) Se nesta side för montering av taket

01-128-000

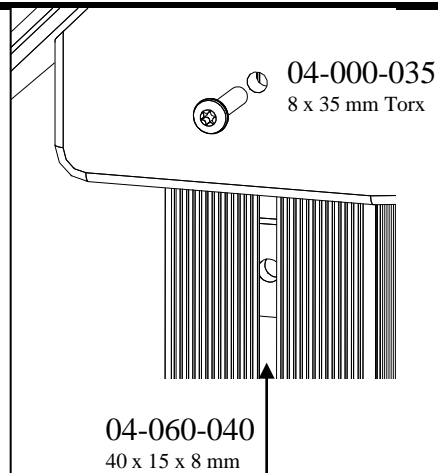
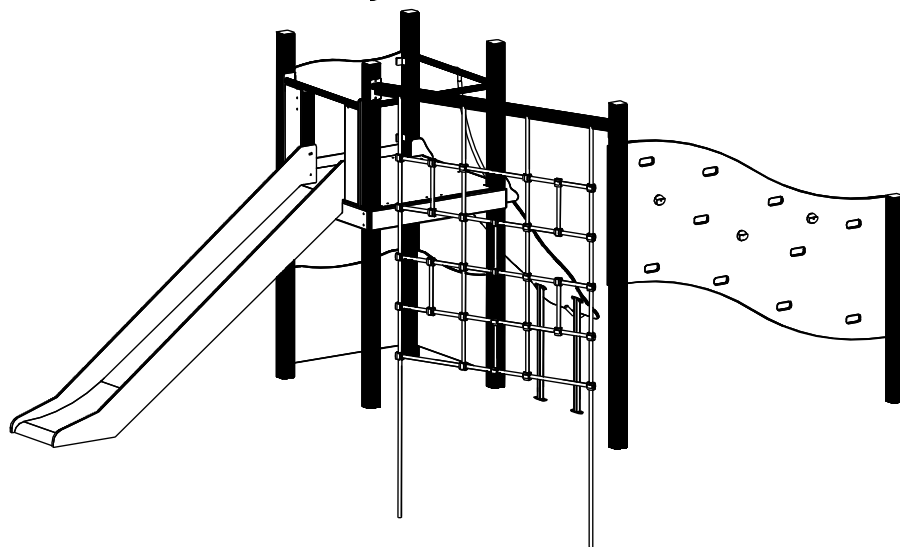
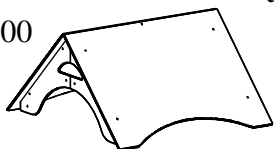

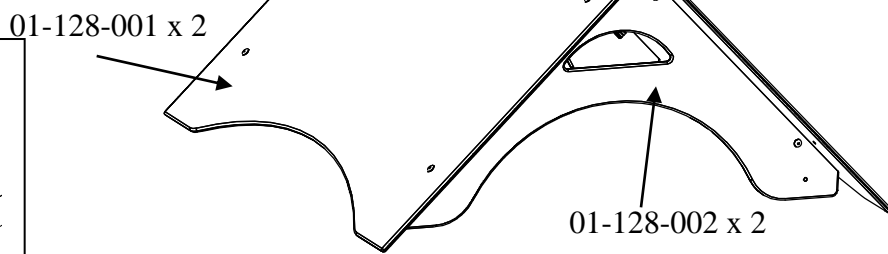
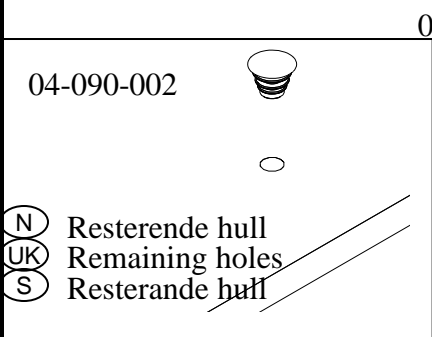
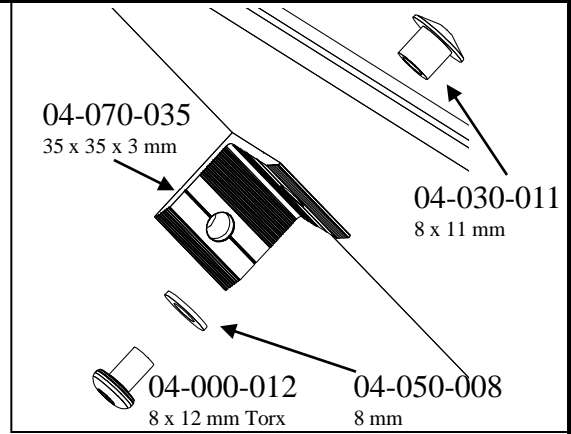
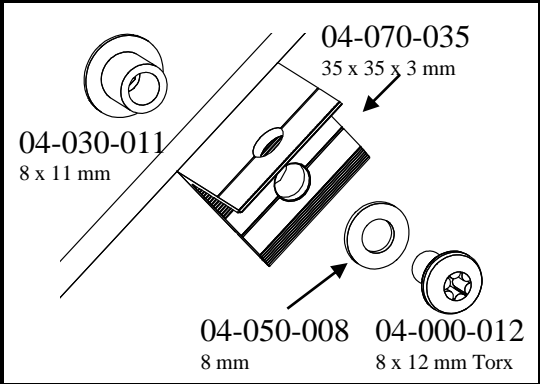

23

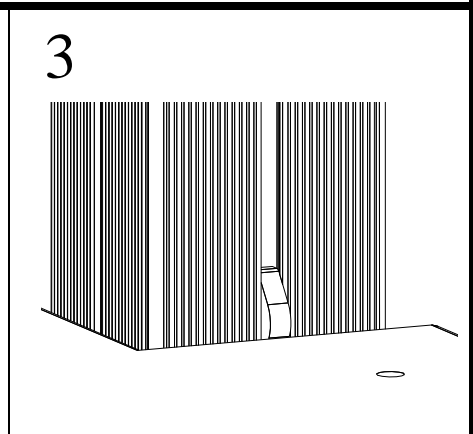
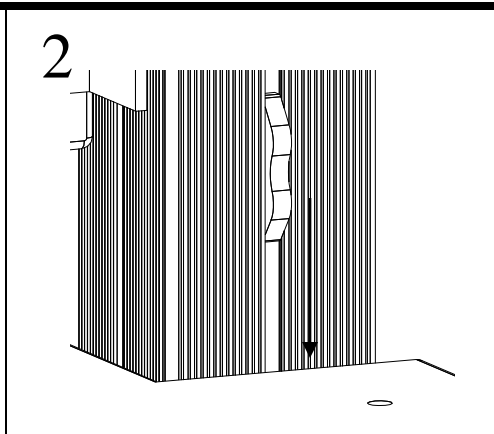
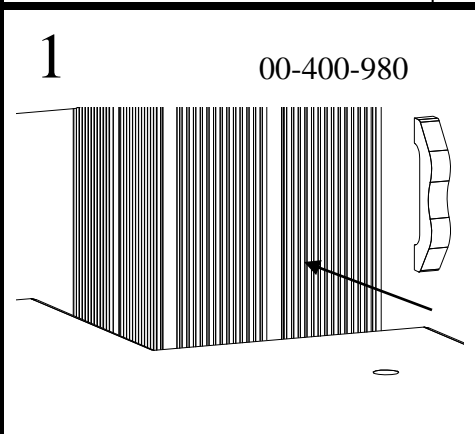

24

N

- ▣ Påse at fallunderlag er lagt i henhold til gjeldende regler eller vår anbefaling
- ▣ Fjern alle monteringshjelpemidler ( rester av betong, planker, paller, plast, og lignende)
- ▣ Før utstyret tas i bruk, sjekk at det ikke er hektefare for anorakksnorer og lignende noen steder på lekeapparatet.

NB! Bør stå i 2-3 dager før bruk når forankring støpes.

UK

- ▣ Make sure the area and depth of safer surfacing are according to the current standard, or to the manufacturer's recommendation
- ▣ Make sure all tools and surplus materials are removed before play begins

PS! When complete, allow 2-3 days for the concrete to set before use.





S

- ▣ Kontrollera att fallunderlag är utlagt enligt gällande regler eller vår rekommendation
- ▣ Ta bort alla monteringshjälpmedel (rester av betong, plankor, pallar, plast och liknande)
- ▣ Innan lekredskapet används, kontrollera att anoracksnoddar eller kläder/delar av kläder eller liknande inte kan fastna i några delar på redskapet.

- ▣ OBS! Bör stå i 2-3 dagar innan användning när det gjuts

Sign. \_\_\_\_\_

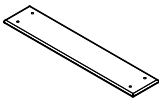
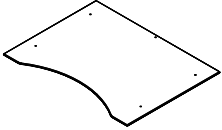
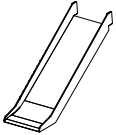
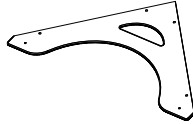
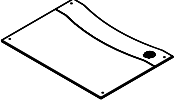
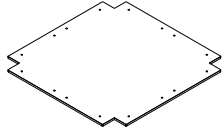

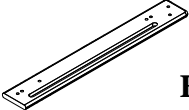
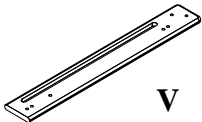
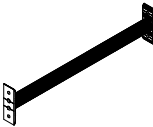
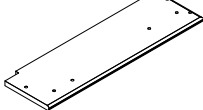
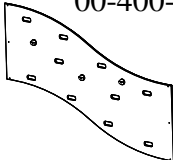
N  
UK  
S

Komponenter Components Komponenter	Dimensjon Dimension Dimension	Ant Qty Ant	Lev Lev	Komponenter Components Komponenter	Dimensjon Dimension Dimension	Ant Qty Ant	Lev Lev
00-400-015 	3235 x 95x 95 Med 2 brikker i hver stolpe	4		01-126-004 	904 x 61 x 37	1	
00-400-032	3235 x 95x 95	1					
00-400-033	2300 x 95 x 95	1					
01-126-005	640 x 95 x 95	2		00-100-310 	512 x120	2	
00-400-101 	1130 x 145 x 15	4		01-128-001 	1280 x 960 x 12	2	
40-142-101 	0,5m x 3m	1		01-128-002 	1216 x 668 x 12	2	
01-125-001 	940 x 686 x 12	3		00-400-300 	1160 x 1160 x 15	1	
00-400-821 	1988 x 150 x 60	1		05-156-003 	1560 x 2980	1	
01-126-001  H	750 x 107,5 x 18	1		N-nett			
01-126-002  V	750 x 107,5 x 18	1		00-400-150 	940 x 120 x 40	1	
01-126-003 	674 x 205 x 18	2		00-400-735 	2930 x 1686 x 15	1	

**Pakkliste for / Parts list for / Packlista för :  
11-145-153**

Sign. \_\_\_\_\_

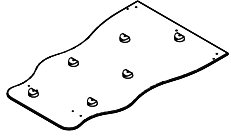
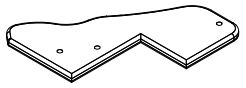
(N)  
(UK)  
(S)

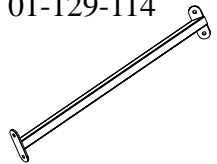
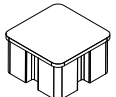



Komponenter Components Komponenter	Dimensjon Dimension Dimension	Ant Qty Ant	Lev Lev Lev	Komponenter Components Komponenter	Dimensjon Dimension Dimension	Ant Qty Ant	Lev Lev Lev
01-129-112 	1480 x 910 x 15	1		(N) Produkt merking (UK) Product marking (S) Produkt märkning		1	
01-129-113 	282 x 263 x 15	2					
00-261-500 	940 x 120	1					
04-080-004 	910 x 40 x 33	1					
01-129-114 	810 x 120 x 40	2					
00-400-998 	55 x 95 x 95	8					
00-400-997 Med hull	55 x 95 x 95	6					





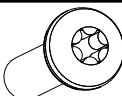
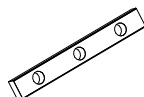







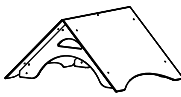

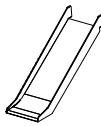

5

**Pakkliste for / Parts list for / Packlista för :  
11-145-153**



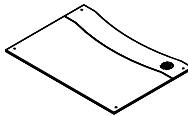







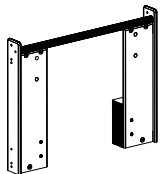

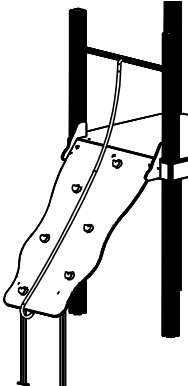



Sign. \_\_\_\_\_

N UK S	Bolter/skruer Bolts/Screws Bultar/Skruvar	Dimensjon Dimension Dimension	Ant Qty Ant	Lev Lev	Bolter/skruer Bolts/Screws Bultar/Skruvar	Dimensjon Dimension Dimension	Ant Qty Ant	Lev Lev
		04-000-025 8 x 25 mm Torx	12				04-060-040 40 x 15 x 8 mm	6
	04-000-035 8 x 35 mm Torx	22				04-060-120 120 x 15 x 8 mm	2	
	00-400-980	4				04-060-160 160 x 15 x 8 mm	2	
	04-040-008 8 mm	4				04-090-002	26	

**Boltepakker for / Boltpackage for / Bultpaket för 11-145-153**

01-128-000  Antall Number Antal		04-060-040 40 x 15 x 8 mm	4					
		04-000-012 8 x 12 mm Torx	22					
		04-000-035 8 x 35 mm Torx	4					
		04-070-035 35 x 35 x 3 mm	11					
		04-030-011 8 x 11 mm	22					
		04-050-008 8 mm	22					
40-142-101  Antall Number Antal		04-060-160 160 x 15 x 8 mm	2					
		04-000-035 8 x 35 mm Torx	4					
		04-000-045 8 x 45 mm Torx	2					
		04-040-008 8 mm	2					
	Monteringsanvisning Assembly Instructions Monteringsanvisning		1					
01-125-001  Antall Number Antal		04-060-040 40 x 15 x 8 mm	4	X 3				
		04-000-025 8 x 25 mm Torx	8	X 3				
		04-076-050 50 x 50 x 5 mm	4	X 3				
				4	X 3			

**Boltepakker for / Boltpackage for / Bultpaket för 11-145-153**









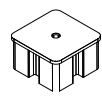



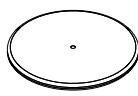

<p>01-400-220</p> 	 <p>04-060-120 120 x 15 x 8 mm</p>	8	<p>01-129-010</p> 	 <p>04-060-120 120 x 15 x 8 mm</p>	2	
	<p>04-000-012 8 x 12 mm Torx</p>	2		 <p>04-060-040 40 x 15 x 8 mm</p>	2	
	<p>04-000-016 8 x 16 mm Torx</p>	6		 <p>04-000-025 8 x 25 mm Torx</p>	5	
	 <p>04-000-035 8 x 35 mm Torx</p>	16			<p>04-000-030 8 x 30 mm Torx</p>	8
	<p>04-000-045 8 x 45 mm Torx</p>	2			<p>04-000-035 8 x 35 mm Torx</p>	4
	 <p>04-090-001 8 mm</p>	2			<p>04-000-040 8 x 40 mm Torx</p>	3
	 <p>04-070-035 35 x 35 x 3 mm</p>	2		<p>04-000-045 8 x 45 mm Torx</p>	2	
	 <p>04-030-011 8 x 11mm</p>	8		 <p>04-040-008 8 mm</p>	9	
	 <p>04-050-008 8 mm</p>	4		 <p>04-070-035 35 x 35 x 3 mm</p>	2	
	 <p>04-090-002</p>	4		 <p>04-030-016 8 x 16 mm</p>	4	
	<p>Monteringsanvisning Assembly Instructions Monteringsanvisning</p>				 <p>04-050-008 8 mm</p>	9
	<p>Antall Number Antal</p>	01-400-220		1	 <p>04-090-001</p>	2

**Forankring / Foundations / Markförankring**

**00-003-003**

N Er bestilt       Ikke bestilt  
 UK In order       Not in order  
 S Bestållt       Ej bestållt

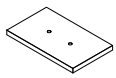
00-400-997 	-6	
---------------------------------------------------------------------------------------------------	----	--

	 00-003-100		<b>6</b>			04-000-035 8 x 35 mm Torx	<b>18</b>	
	 00-003-101					04-050-008 8 mm	<b>18</b>	
	 00-003-102					04-060-120 120 x 15 x 8 mm	<b>12</b>	
	00-003-103 		<b>4</b>			04-000-040 8 x 40 mm Torx	<b>4</b>	
						04-040-008 8 mm	<b>4</b>	
						04-050-008 8 mm	<b>4</b>	
Eller Or Eller	00-003-105 		<b>4</b>			04-010-035 10 x 35 mm	<b>8</b>	
	00-003-106 					04-040-010 10 mm	<b>8</b>	
						04-050-010 10 mm	<b>8</b>	