

(N) Monteringsanvisning

(UK) Assembly Instructions

(S) Monteringsanvisning

Produkt nr. / Product no. / Produkt nr.

11-145-157

Ordr. nr. _____

Dato. _____

Sign. _____

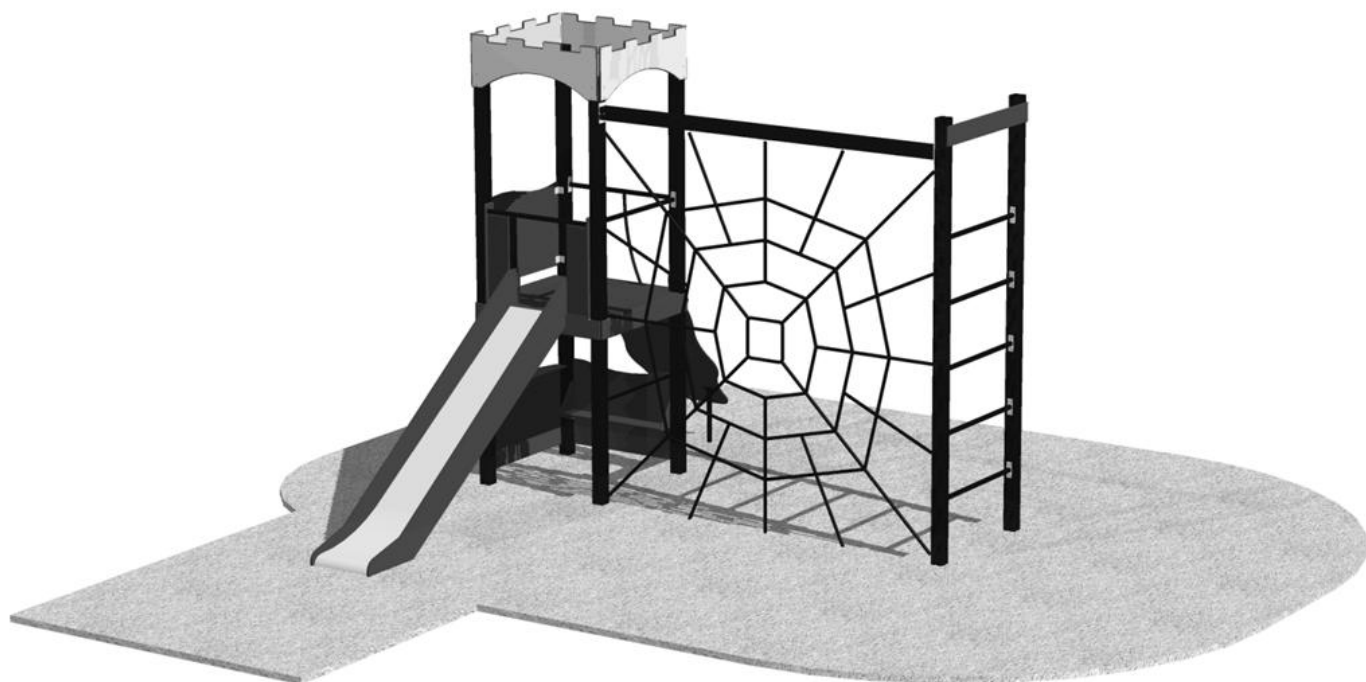

Søve Lekemiljø AS
3830 Ulefoss - Norway
Tlf: +47 35 94 65 65
www.sove.no



Søve AB
412 50 Göteborg
Phone: +46 (0)31 773 97 00
www.sove.se

21.12.2011

- ▣ Les monteringsanvisningen nøye før montering.
 - ▣ Monter elementene i rekkefølgen som vist.
 - ▣ Boltene bør ikke skrues for hardt til før alt er montert, vatret og loddet. Skru så boltene til.
- NB! Ved bruk av drill, kan boltene ryke.
- ▣ På grunn av at solen kan gjøre rutsjeflaten veldig varm, bør rutsjebanens utløp vende mot nord-øst eller nord-vest.
 - ▣ Er lekeutstyret plassert i naturlige ferdselstraséer må området sikres mot spontan gjennomgang.
 - ▣ Innspringningshinder bør vurderes rundt lekeapparater hvor det er stor bevegelse, f.eks. ved huskestativ.
 - ▣ Det bør være fritt innsyn til lekeutstyr som er beregnet for barn under 3 år.

NB! Under monteringsarbeidet må utstyr, som ikke er forankret forsvarlig i bakken, avstives slik at det ikke velte. Området må avstenges under oppsettelse av apparatene med sperrebånd eller lignende.

- ▣ Read the instruction carefully before assembling the play unit.
 - ▣ Assemble the components in the sequence shown in these instructions.
 - ▣ Fixings must not be fully tightened during assembly. Before casting the foundations, the structure must be level and plumb, at which point all fixings are tightened.
- PS! If use of drill, the bolts may be wrecked.
- ▣ Avoid positioning the slide facing due south because of overheating – ideal positions are facing north-east or north-west.
 - ▣ Secure the construction-area to prevent people from walking through it.
 - ▣ Consider installing barriers around play-equipment which gives rise to a lot of activity – i.e. swings.
 - ▣ Ensure that clear vision is possible across the play area so that supervision is possible from any position, particularly where children under 3 years of age will be playing.

NB! During assembly of the equipment, ensure that all structures are securely propped, especially when left overnight. Also ensure that equipment is supported whilst concrete foundations are setting and enclose the area securely to prevent access.

▮ Läs monteringsanvisningen noga före montering.

▮ Montera delarna i den ordningen som anvisas

▮ Skruvarna bör inte skruvas för hårt tills allt är monterat, i våg och lodat.

OBS! Används elektrisk skruvdragare, kan bulten gå sönder. Hårdra därför manuellt!

▮ Solen kan göra att rutchbanan blir väldigt varm. Banans nedfart rekommenderas att vändas i norrlig riktning

▮ Om lekplatsen placeras vid en gångväg mm bör området säkras mot genomfart av gående och cyklister.

▮ Inspringningshinder bör placeras runt lekutrustning med stor rörelse, t ex, gungställning.

▮ Det bör vara fri insyn till lekutrustning beräknat till barn under 3 år.

OBS! Under monteringsarbete bör utrustningen som inte ska förankras i marken, ställs så att den inte kan välta.

Området måste spärras när lekutrustningen byggs upp, med avspärrningsband eller liknande.

2

Nødvendig verktøy / Tools required / Nödvändiga verktyg

N
UK
S

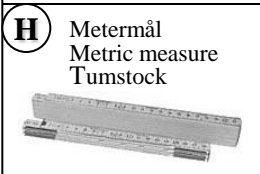
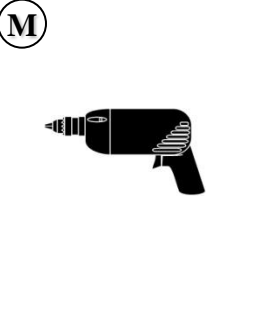
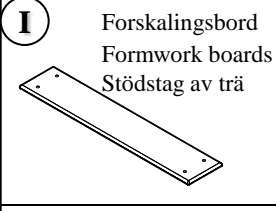
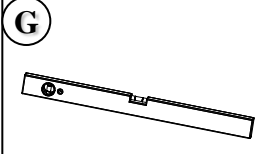
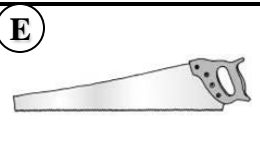
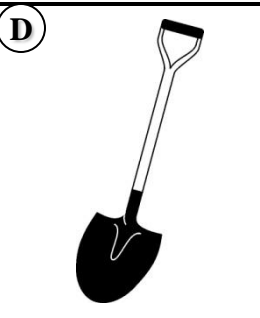
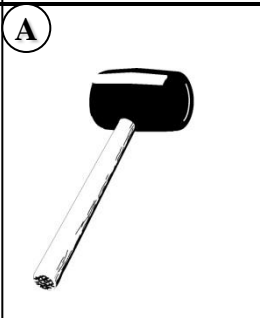

3

Nødvendig antall personer / Number of persons required / Lämpligt antal personer

N
UK
S

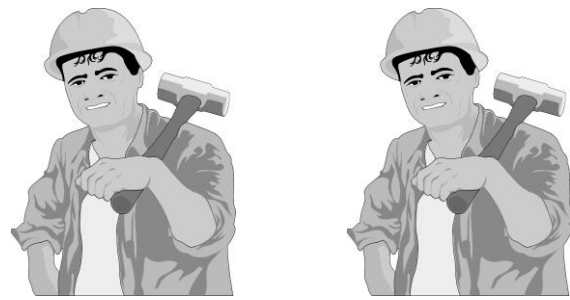







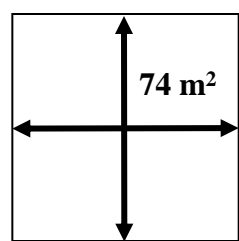



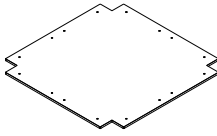

4

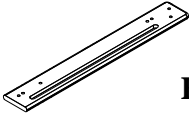
Anbefalt arealbehov ved montering / Recommended working space / Rekommenderad arealbehov vid montering

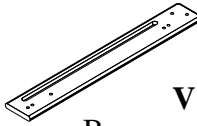

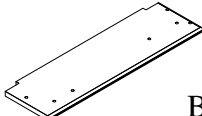
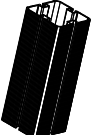

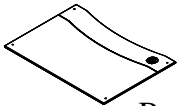
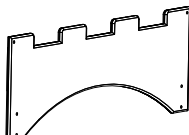
N
UK
S

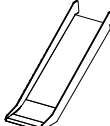



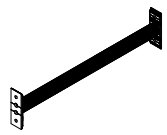
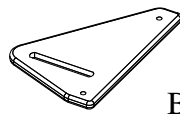
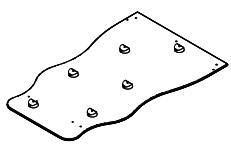
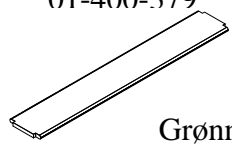
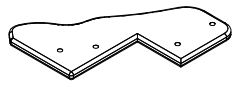
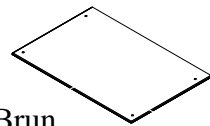

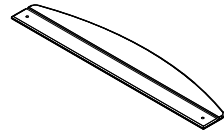

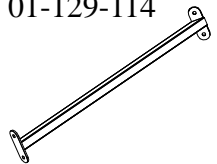
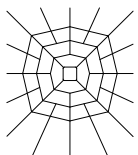
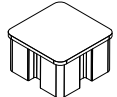

N
UK
S

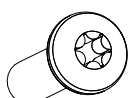
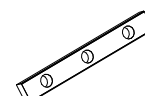
Komponenter Components Komponenter	Dimensjon Dimension Dimension	Ant Qty Ant	Lev Lev	Komponenter Components Komponenter	Dimensjon Dimension Dimension	Ant Qty Ant	Lev Lev
01-400-078 	2815 x 95 x 95 Inkl.Beslag	1		00-400-101 	1130 x 145 x 15	5	
01-400-079		1		Grønn			
01-400-081 	4000 x 95 x 95	1		00-400-300 	1160 x 1160 x 15	1	
01-400-082 	4000 x 95 x 95 Inkl.Beslag	1		01-126-001 	750 x 107,5 x 18	1	
01-400-083 	4000 x 95 x 95 Inkl.Beslag	1		01-126-002 	750 x 107,5 x 18	1	
01-400-084 	4000 x 95 x 95	3		01-126-003 	674 x 205 x 18	2	
01-126-005 	640 x 95 x 95	2		01-126-004 	904 x 61 x 37	1	
01-125-001 	940 x 686 x 12	2		01-400-502 	1130 x 400 x 18	4	
00-100-310 	512 x 120	2		40-142-101 	0,5m x 3m	1	
				Grønn			









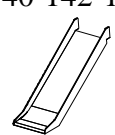

(N)
(UK)
(S)

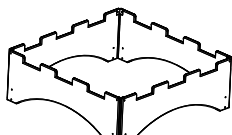



Komponenter Components Komponenter	Dimensjon Dimension Dimension	Ant Qty Ant	Lev Lev	Komponenter Components Komponenter	Dimensjon Dimension Dimension	Ant Qty Ant	Lev Lev
00-400-150 	940 x 120 x 40	6		01-400-381  Brun 01-400-382	300 x 194 x 12	1	
01-129-112 	1480 x 910 x 15	1		01-400-379  Grønn	930 x 150 x 12	1	
01-129-113 	282 x 263 x 15	2		01-125-013  Brun	940 x 630 x 12	1	
00-261-500 	940 x 120	1		01-125-014 	940 x 195 x 12	1	
04-080-004 	910 x 40 x 33	1					
01-129-114 	810 x 120 x 40	2					
	3295 x 2815	1					
00-400-998 	55 x 95 x 95	8					
00-400-997 Med hull	55 x 95 x 95	6					

N
UK
S



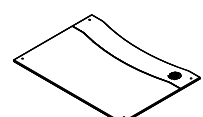







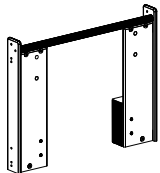

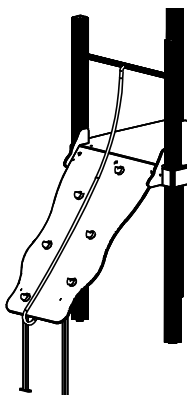



Bolter/skruer Bolts/Screws Komponenter	Dimensjon Dimension Dimension	Ant Qty Ant	Lev Lev	Bolter/skruer Bolts/Screws Bultar/Skruvar	Dimensjon Dimension Dimension	Ant Qty Ant	Lev Lev				
	04-000-020 8 x 20 mm Torx	16			04-060-120 120 x 15 x 8 mm	12					
	04-000-025 8 x 25 mm Torx	44									
	04-000-030 8 x 30 mm Torx	2			04-060-040 40 x 15 x 8 mm	8					
	04-000-035 8 x 35 mm Torx	24									
	04-000-012 8 x 12 mm Torx	1									
	04-030-016 8 x 16 mm	2			04-090-002	26					
	04-040-008 8 mm	24									
	04-050-008 8 mm	2						 Spesial til gulv	04-075-050 50 x 50 x 5 mm	2	
									04-076-050 50 x 50 x 5 mm	10	

Boltepakker for / Boltpackage for / Bultpaket för 11-145-157

40-142-101 	 04-060-160 160 x 15 x 8 mm	2	01-400-501 	 04-060-120 120 x 15 x 8 mm	8
	 04-000-035 8 x 35 mm Torx	4		 04-000-025 8 x 25 mm Torx	8
	 04-000-045 8 x 45 mm Torx	2		 04-000-035 8 x 35 mm Torx	16
	 04-040-008 8 mm	2		 04-040-008 8 mm	8
Antall Number Antal	Monteringsanvisning Assembly Instructions Monteringsanvisning	1	Antall Number Antal	 04-076-050 50 x 50 x 5 mm	4

01-125-001 	 04-060-040 40 x 15 x 8 mm	4 X 2	
	 04-000-025 8 x 25 mm Torx	8 X 2	
	 04-076-050 50 x 50 x 5 mm	4 X 2	
	 04-040-008 8 mm	4 X 2	
Antall Number Antal			

Sign. _____









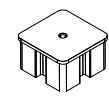



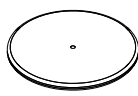

<p>01-400-220</p> 	 <p>04-060-120 120 x 15 x 8 mm</p>	8	<p>01-129-110</p> 	 <p>04-060-120 120 x 15 x 8 mm</p>	4	
	<p>04-000-012 8 x 12 mm Torx</p>	2		<p>04-000-025 8 x 25 mm Torx</p>	5	
	<p>04-000-016 8 x 16 mm Torx</p>	6		<p>04-000-030 8 x 30 mm Torx</p>	8	
	 <p>04-000-035 8 x 35 mm Torx</p>	16		 <p>04-000-035 8 x 35 mm Torx</p>	4	
	<p>04-000-045 8 x 45 mm Torx</p>	2		<p>04-000-040 8 x 40 mm Torx</p>	3	
	 <p>04-090-001 8 mm</p>	2		<p>04-000-045 8 x 45 mm Torx</p>	2	
	 <p>04-070-035 35 x 35 x 3 mm</p>	2		 <p>04-040-008 8 mm</p>	9	
	 <p>04-030-011 8 x 11mm</p>	8		 <p>04-070-035 35 x 35 x 3 mm</p>	2	
	 <p>04-050-008 8 mm</p>	4		 <p>04-030-016 8 x 16 mm</p>	3	
	 <p>04-090-002</p>	4		 <p>04-050-008 8 mm</p>	9	
	<p>Monteringsanvisning Assembly Instructions Monteringsanvisning</p>				 <p>04-090-001</p>	2
	<p>Antall Number Antal</p>	<p>01-400-220</p>		1		

Forankring / Foundations / Markförankring

00-003-003

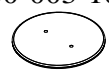
N Er bestilt Ikke bestilt
 UK In order Not in order
 S Bestållt Ej bestållt

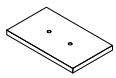
00-400-997 	-6	
---	----	--

	 00-003-100		6			04-000-035 8 x 35 mm Torx	18	
	 00-003-101					04-050-008 8 mm	18	
	 00-003-102					04-060-120 120 x 15 x 8 mm	12	
	00-003-103 		0			04-000-040 8 x 40 mm Torx	0	
						04-040-008 8 mm	0	
						04-050-008 8 mm	0	
Eller Or Eller	00-003-105 		4			04-010-035 10 x 35 mm	8	
	00-003-106 					04-040-010 10 mm	8	
						04-050-010 10 mm	8	

6

Fundamentering med betong / Foundation concrete / Förankring med betong



(N) Bakkenivå (UK) Ground level (S) Marknivå

(N) Støtsand
(UK) Safer surface
(S) Stridsand

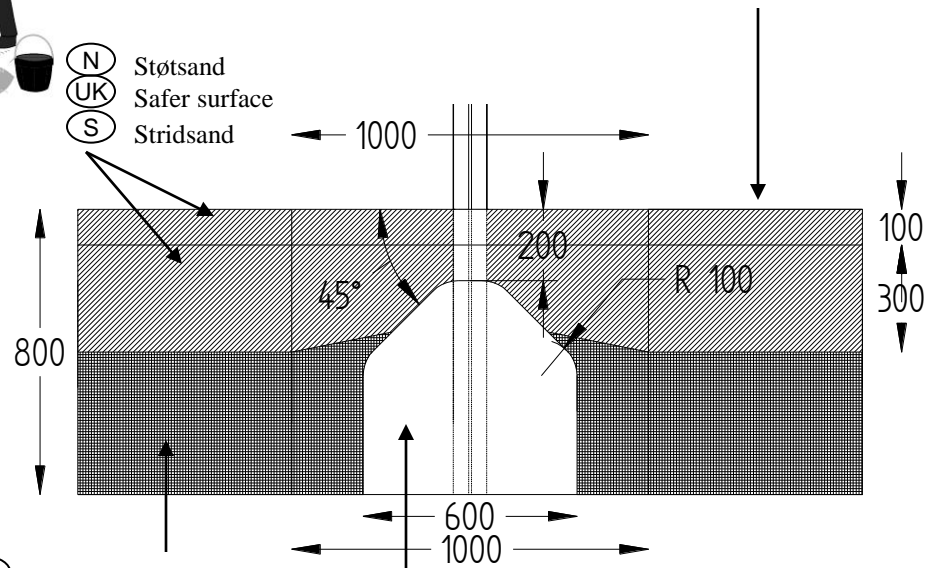

(N) Komprimert masse. betong
(UK) Compressed mass. concrete
(S) Komprimerad massa. betong

6

Fundamentering uten betong / Foundation without concrete / Förankring utan betong

(N) Bakkenivå (UK) Ground level (S) Marknivå

(N) Støtsand
(UK) Safer surface
(S) Stridsand

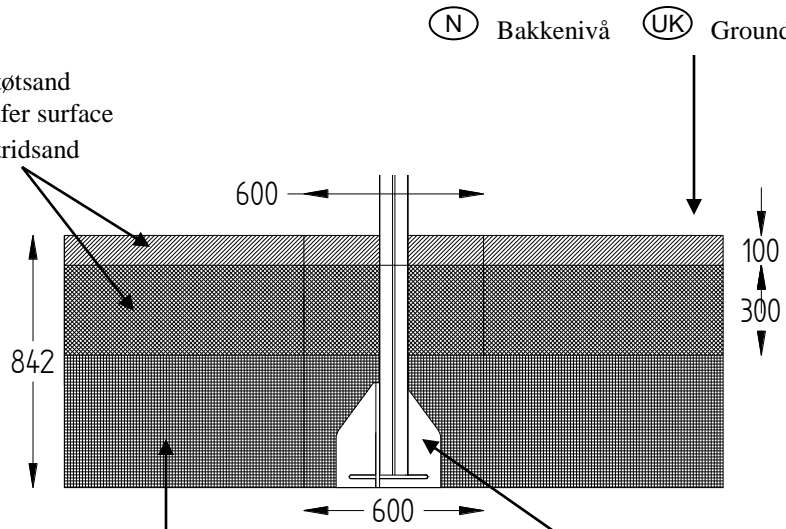

(N) Komprimert masse Støpefri nedgraving
(UK) Compressed mass Concrete-free anchor
(S) Komprimerad massa Nedgravningsfundament

(N) Alle mål er oppgitt i millimeter
(UK) Scale measured in mm
(S) Alla mått är i millimeter.

- (N) For klatrenett
- (UK) For climbing net
- (S) För klätternät

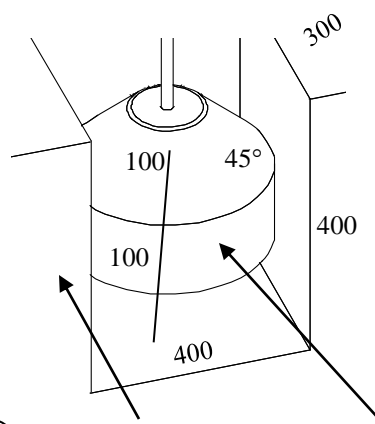

- (N) Komprimert masse. betong
- (UK) Compressed mass. concrete
- (S) Komprimerad massa. betong

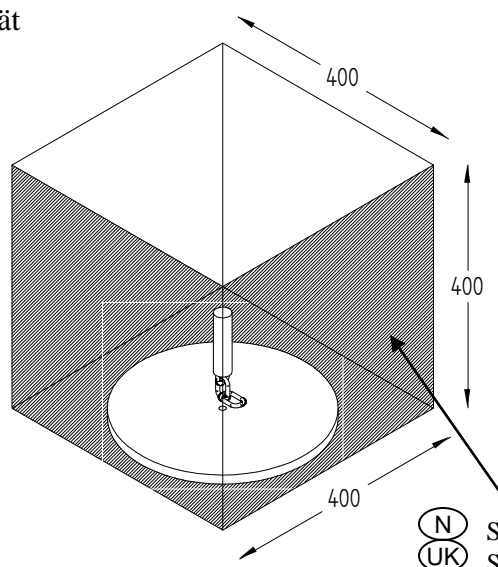

- (N) Støtsand
- (UK) Safer surface
- (S) Stridsand

- (N) Alle mål er oppgitt i millimeter
- (UK) Scale measured in mm
- (S) Alla mått är i millimeter.

6

(N) Dybde for støping og forankring

(UK) Depth of foundations /

(S) Djup för gjutning och markförankring

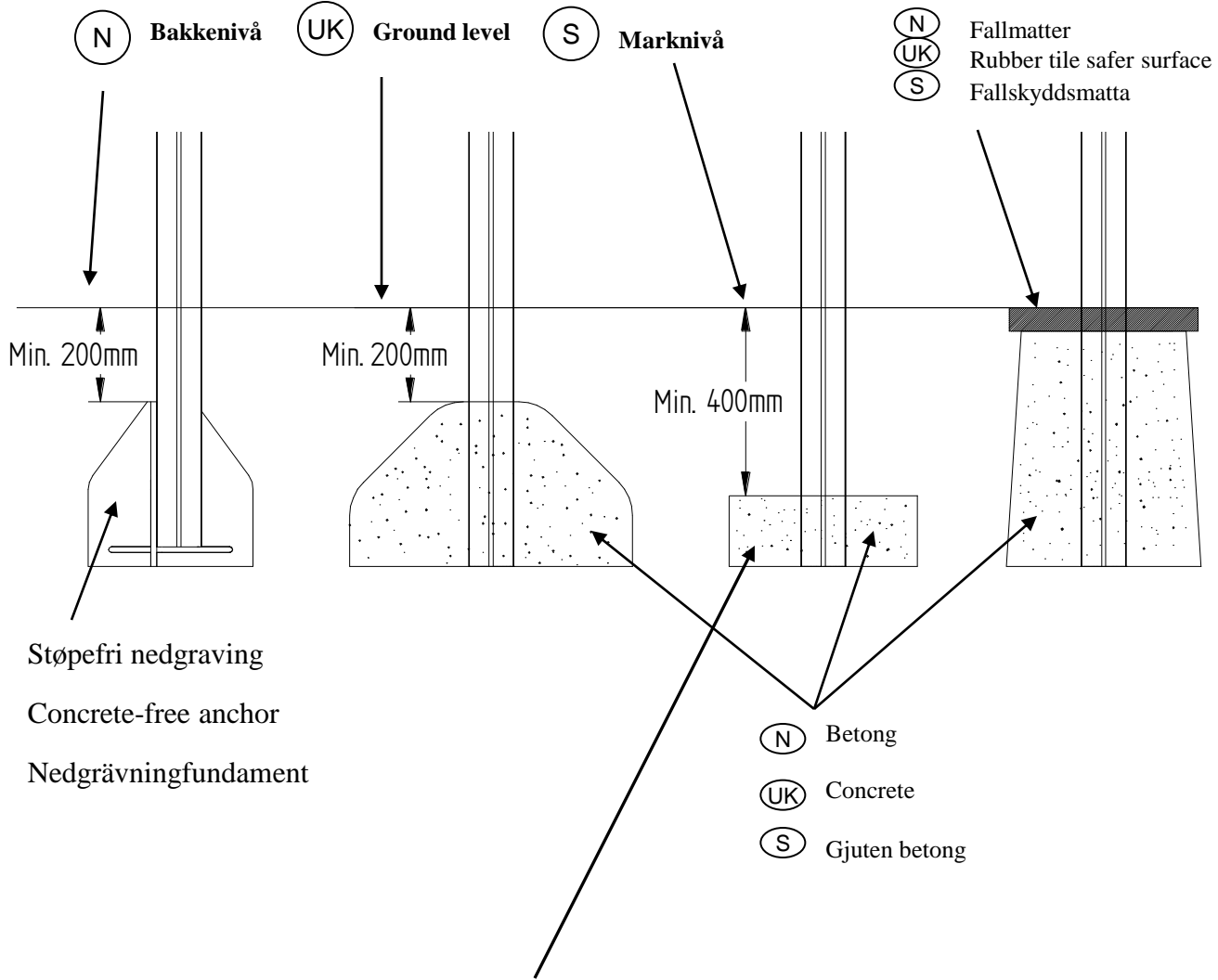

(N) Støpefri nedgraving
 (UK) Concrete-free anchor
 (S) Nedgrävningfundament

(N) Betong
 (UK) Concrete
 (S) Gjuten betong

(N) Denne støpemetoden anbefales ikke grunnet dårlig stabilitet av lekeapparatet.

(UK) This anchor is recommend not to use because of poor stability of the play unit.

(S) Denna förankring avrådes från att användas, därför att lekutrustningen får dålig fäste.

1

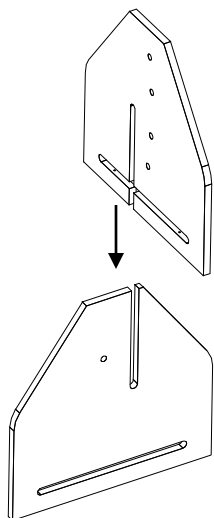

2

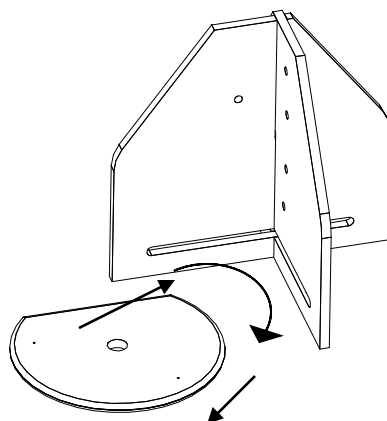

3

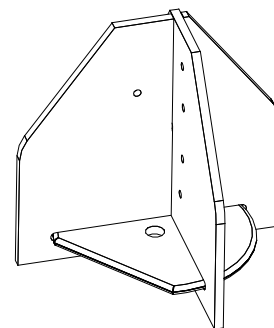

4

04-060-120 x 2
120 x 15 x 8 mm

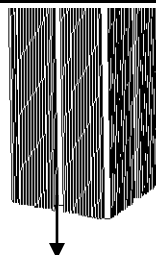

04-000-035 x 3
8 x 35 mm Torx

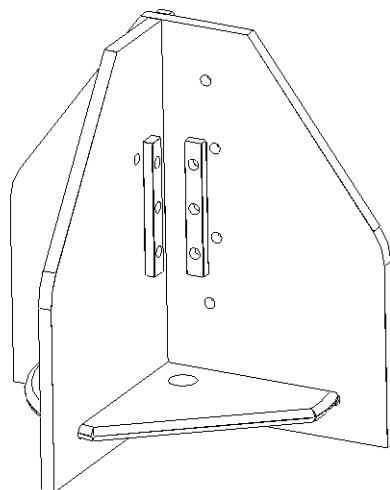

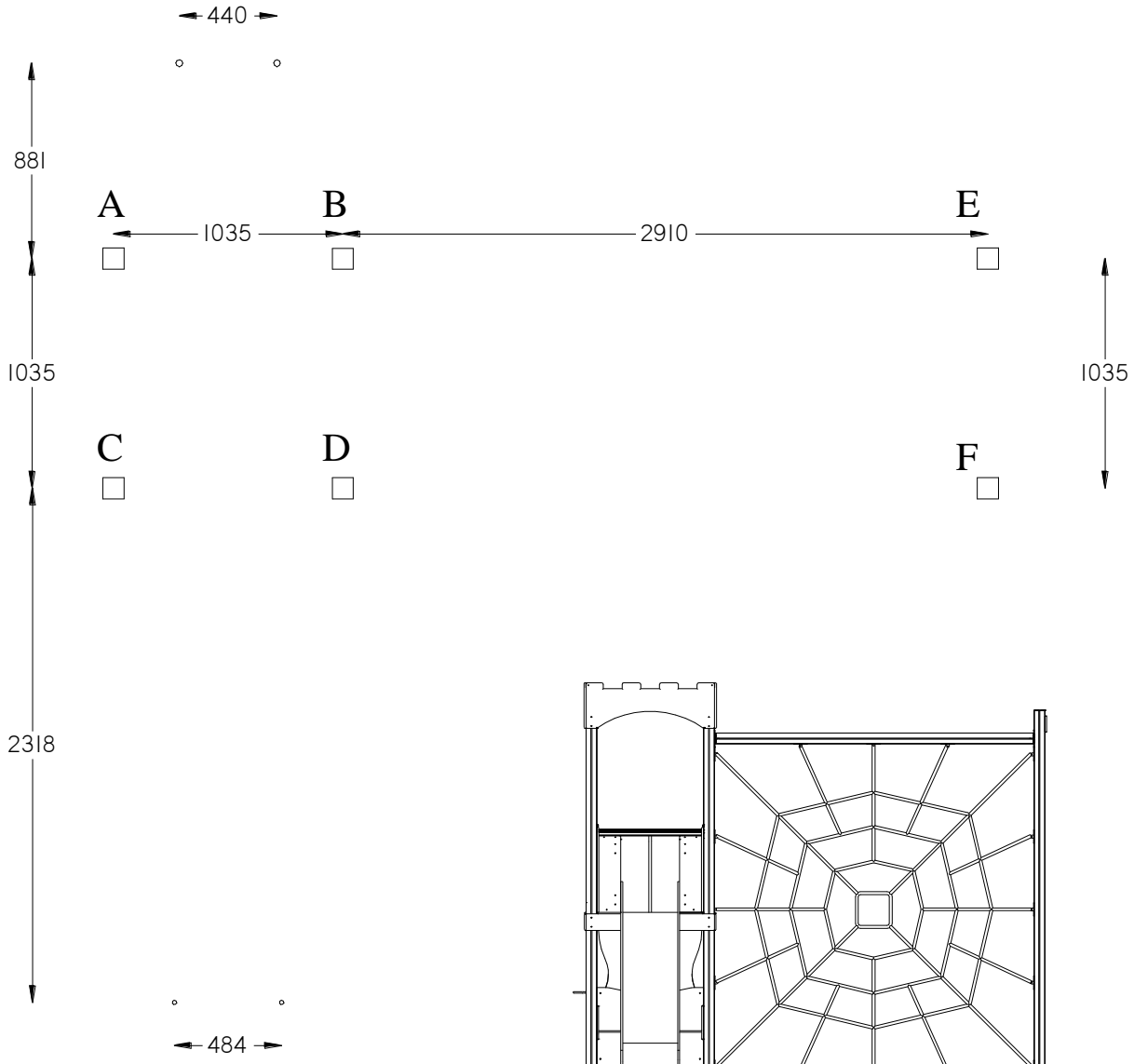

- (N) Bakkenivå
- (UK) Ground level
- (S) Marknivå

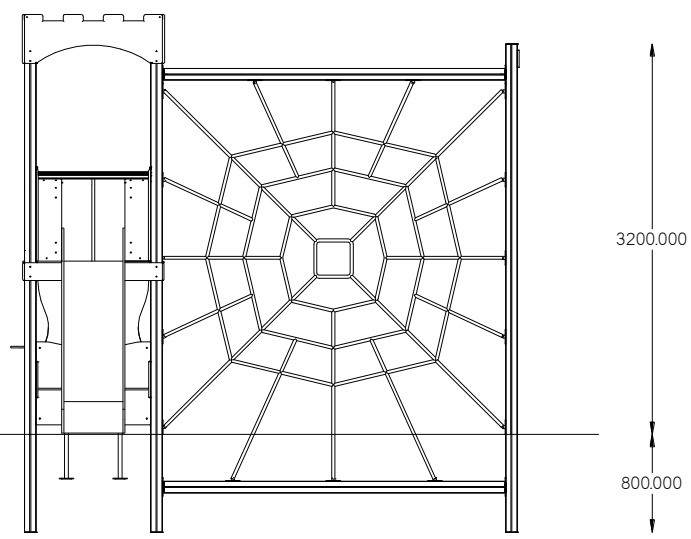

- (N) Alle mål er oppgitt i millimeter
- (UK) Scale measured in mm
- (S) Alla mått är i millimeter.

7

Sikkerhetszone / Safety zone / Säkerhetszon

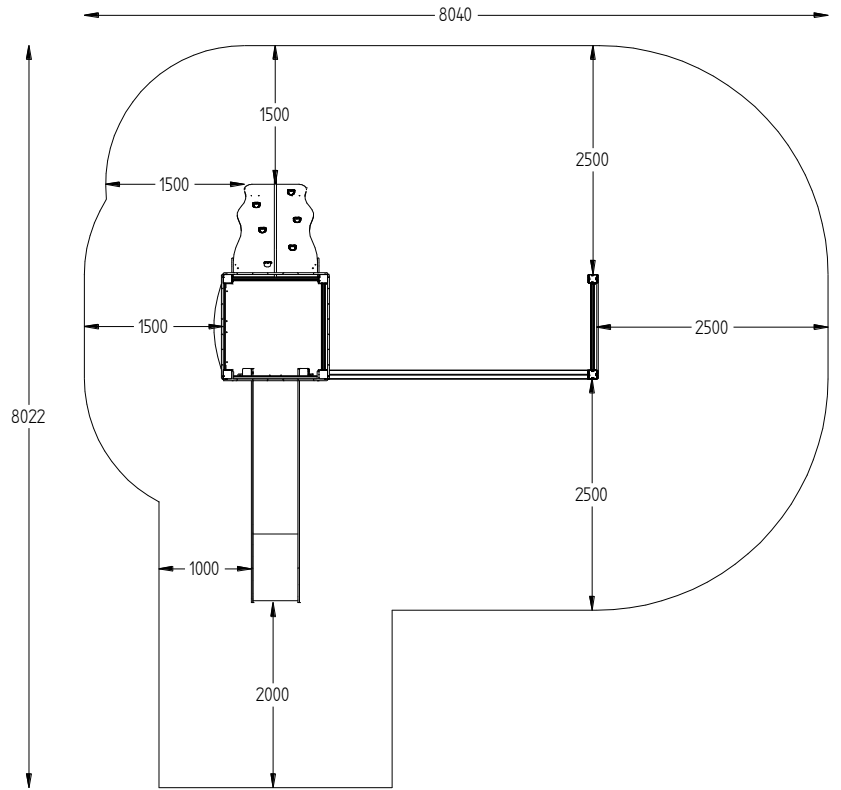

(N)

Alle mål er oppgitt i millimeter

(UK)

Scale measured in mm

(S)

Alla mått är i millimeter.

8

Fallhøyder / Free height of fall / Fallhöjder

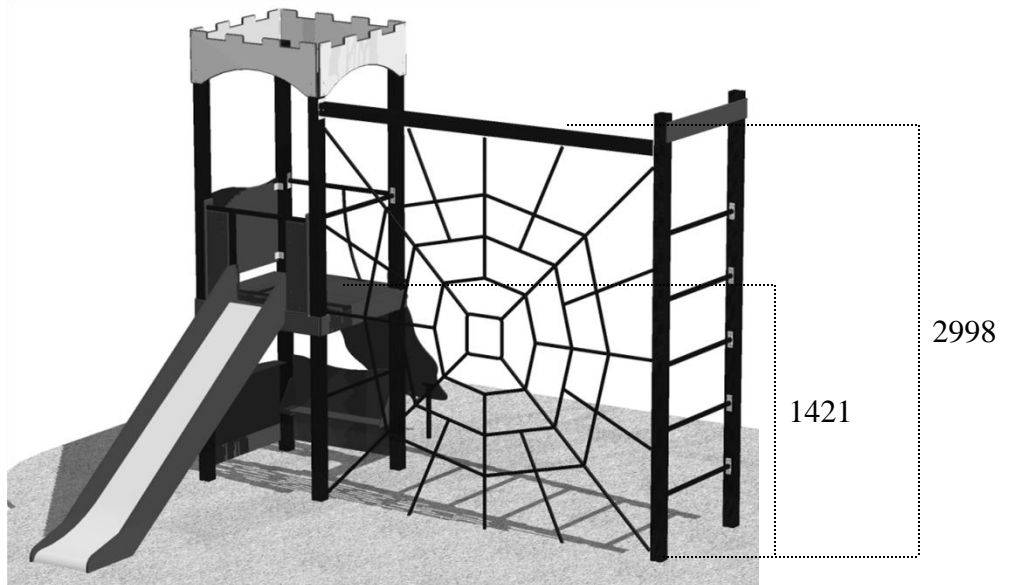

(N)

Alle mål er oppgitt i millimeter

(UK)

Scale measured in mm

(S)

Alla mått är i millimeter.

OBS !

- Ⓝ Bolter skrues helt igjennom aluminiumstolpene. Om elektrisk drill brukes anbefales 18 V
- ⓊⓀ Bolts must be tightened through the post, so that it pierces the aluminium.
- Ⓢ Bultarna skruvas rakt igenom aluminiumstolparna. Om elektrisk skruvdragare används rekommenderas 18 V

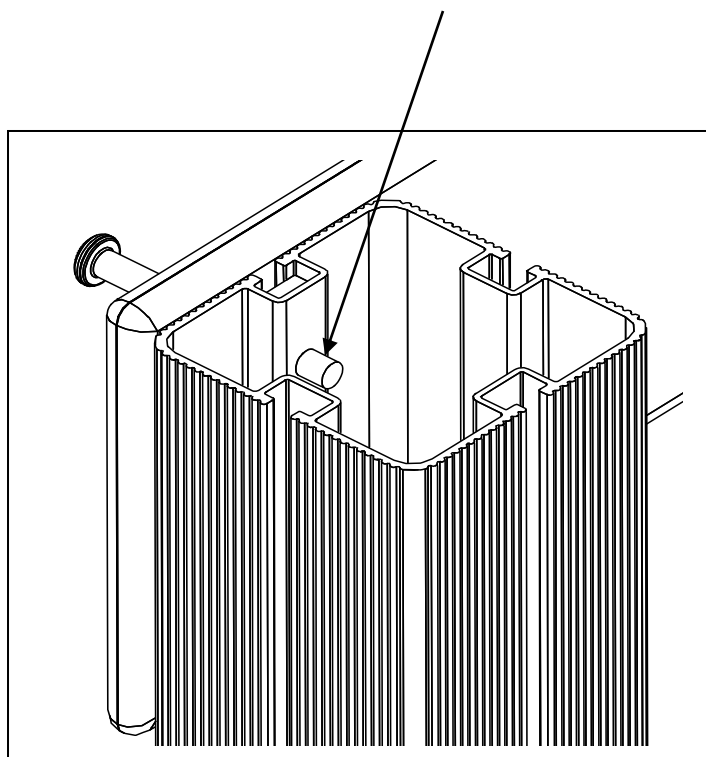

- (N) Med bruk av betong
- (UK) With use of concrete
- (S) Med bruk av betong

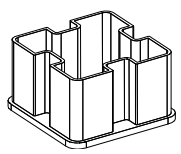
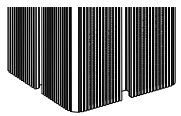

00-400-997

00-400-084

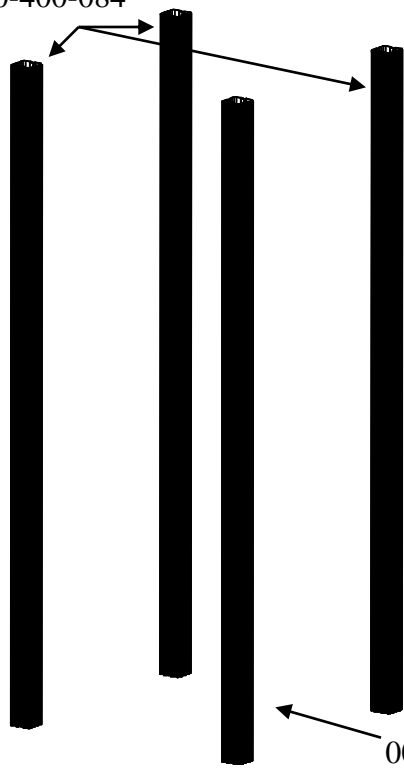

00-400-083

1

01-400-110

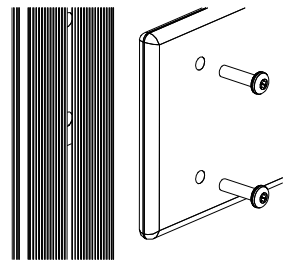

04-000-050
8 x 50 mm Torx

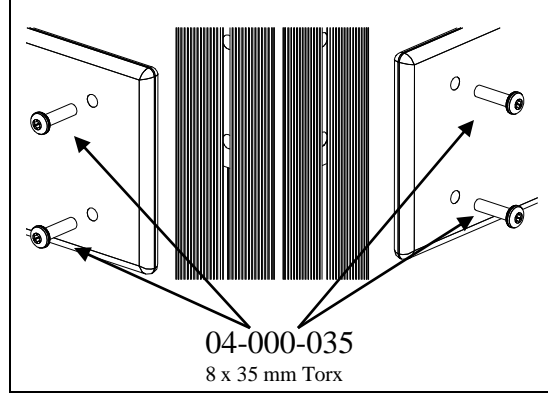

04-000-035
8 x 35 mm Torx

01-400-101

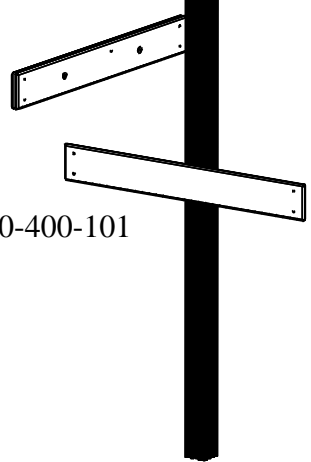

00-400-101

00-400-101

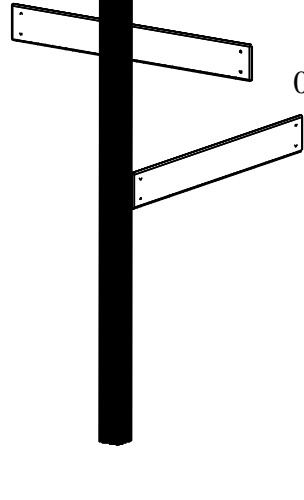

2

A+B

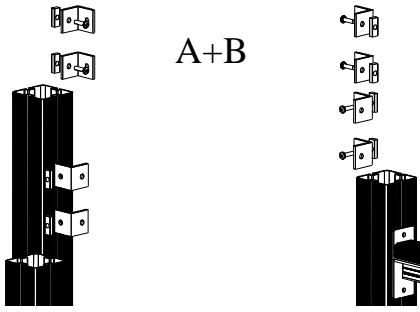

04-060-040
40 x 15 x 8 mm

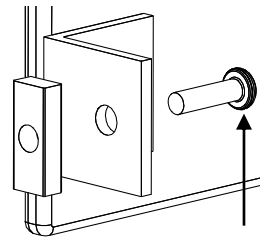

04-000-025
8 x 25 mm Torx

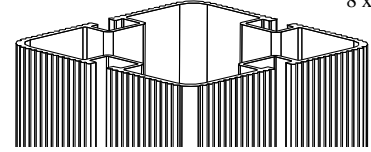

- (N) Bakkenivå
- (UK) Ground level
- (S) Marknivå

C+D

01-125-001

40 mm

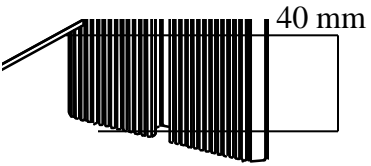

01-400-381
01-400-382

01-400-379

C

D

01-125-014

01-125-013

04-000-025
8 x 25 mm Torx

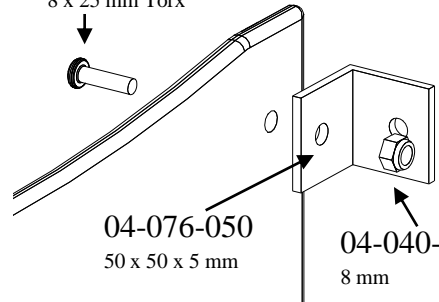

04-076-050
50 x 50 x 5 mm

04-040-008
8 mm

04-000-025
8 x 25 mm Torx

04-060-040
40 x 15 x 8 mm

04-000-025
8 x 25 mm Torx

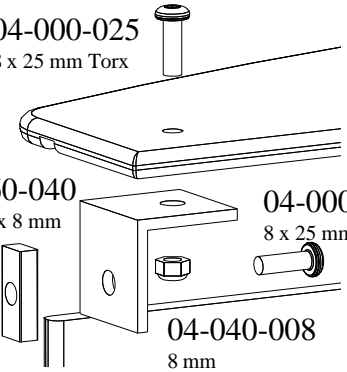

04-040-008
8 mm

04-000-035
8 x 35 mm Torx

04-060-040
40 x 15 x 8 mm

01-125-001

01-125-001

365 mm

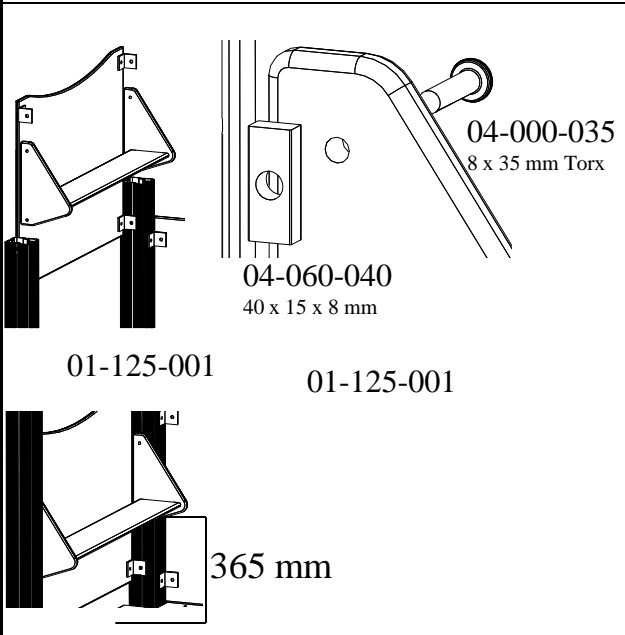

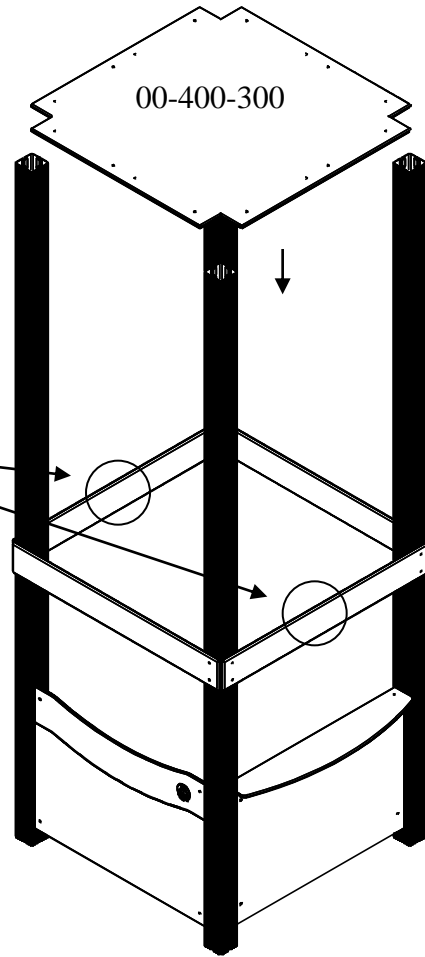
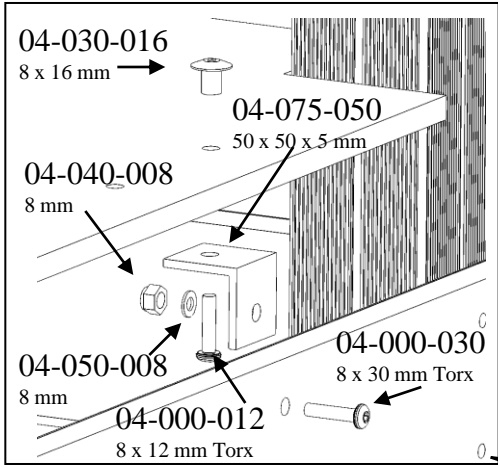

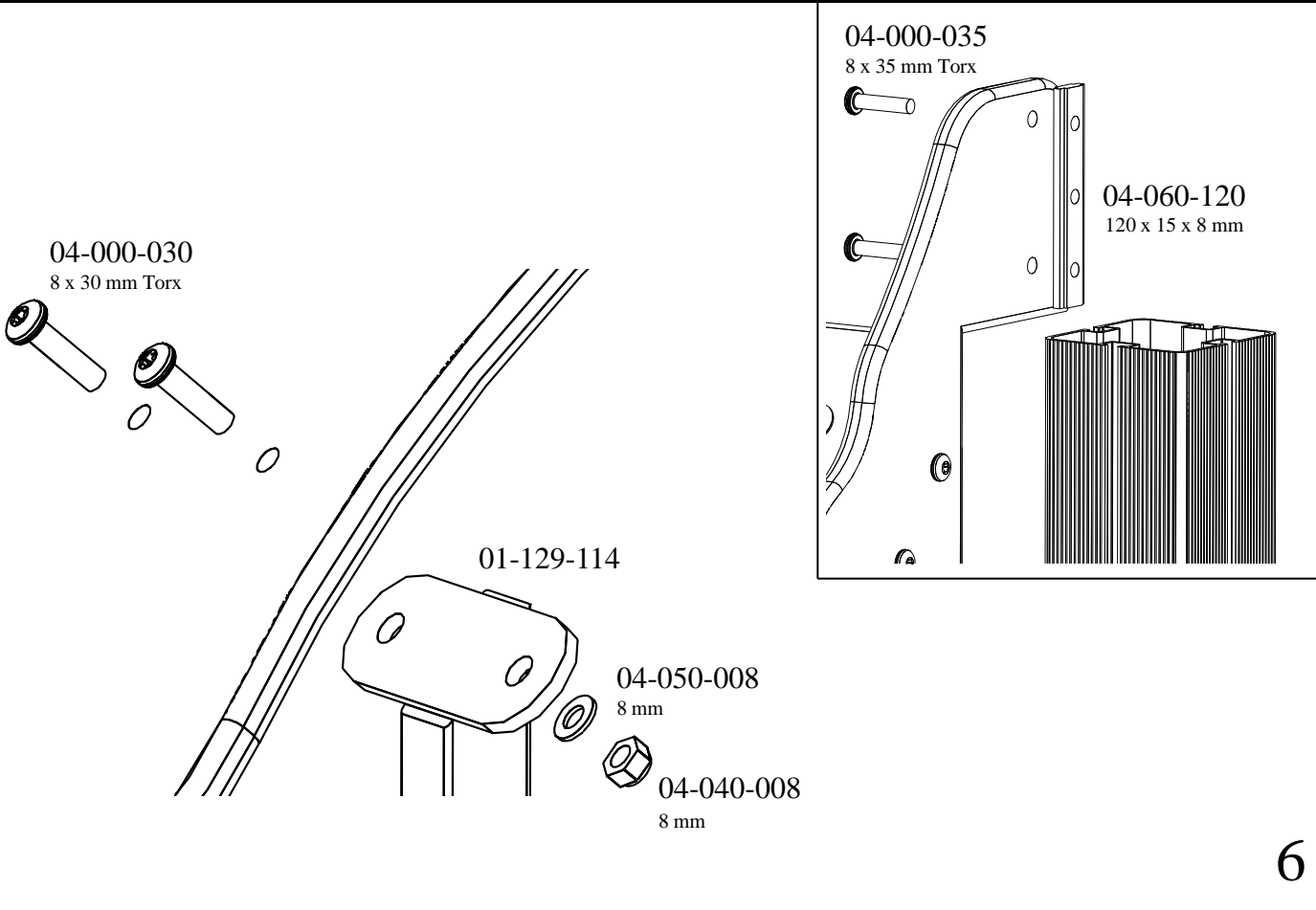
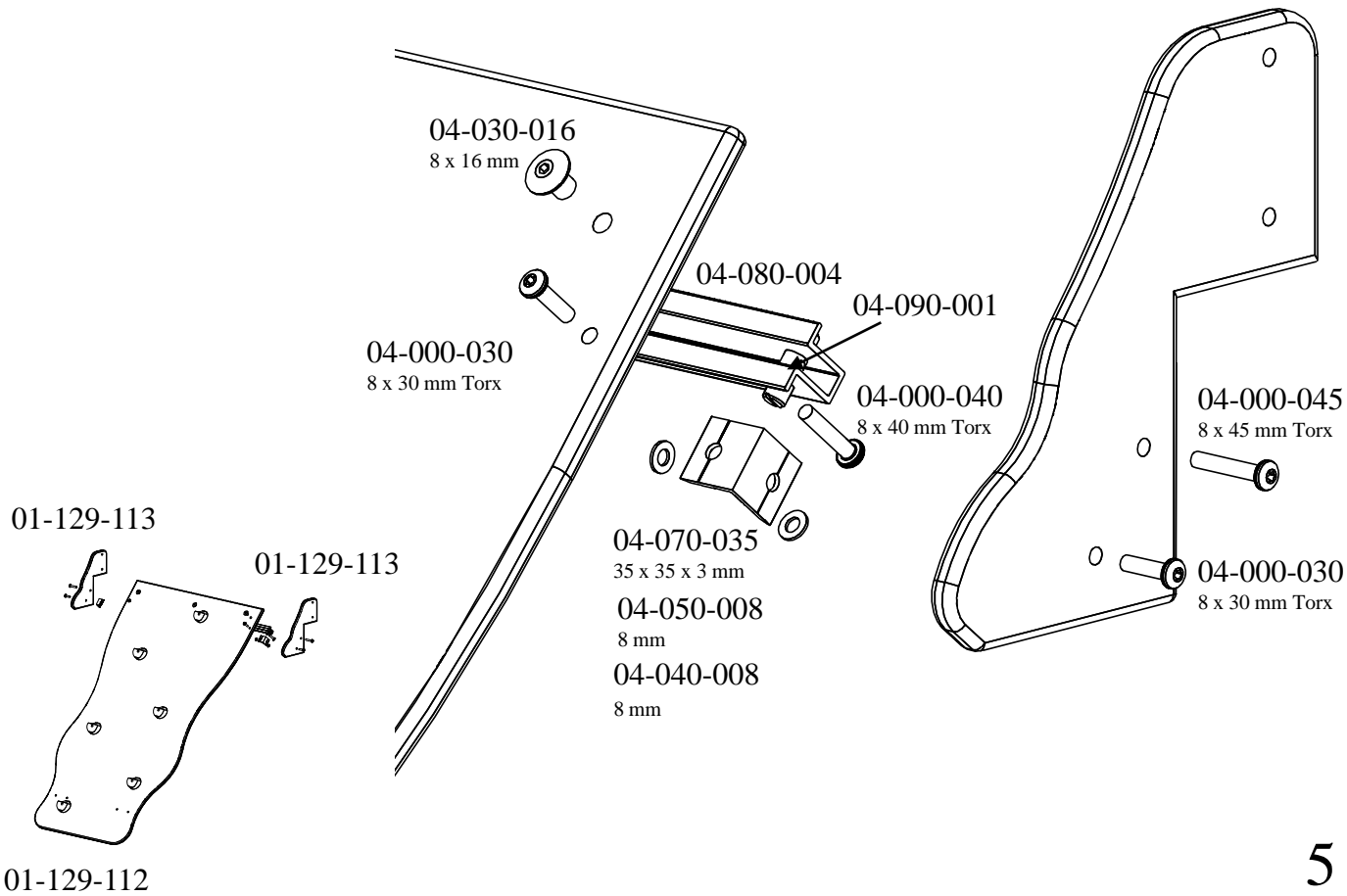

04-000-035

8 x 35 mm Torx

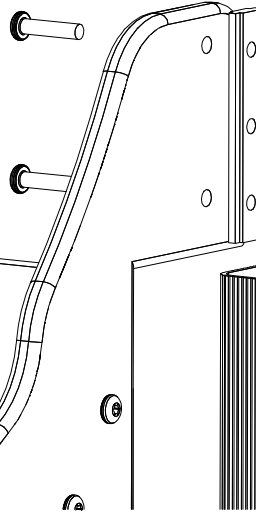

04-060-120

120 x 15 x 8 mm

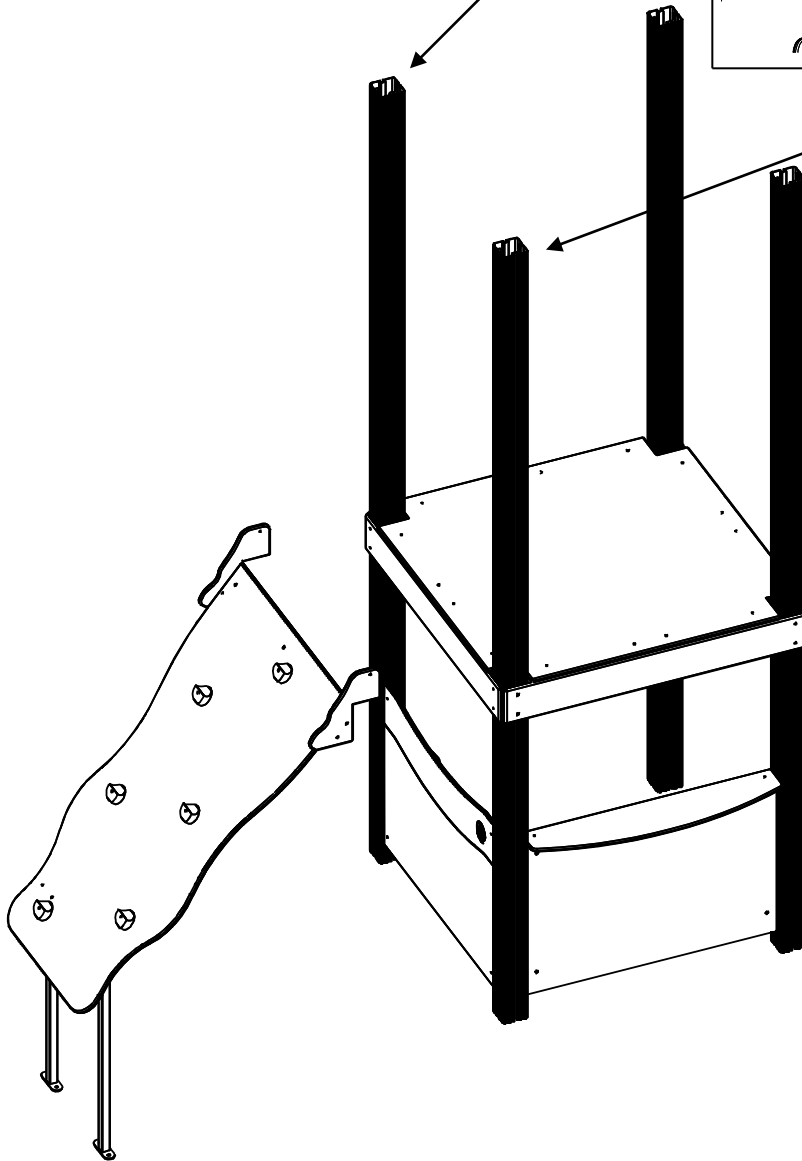
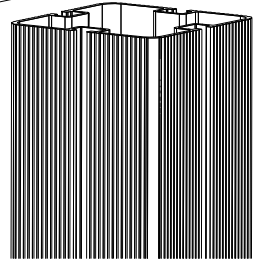

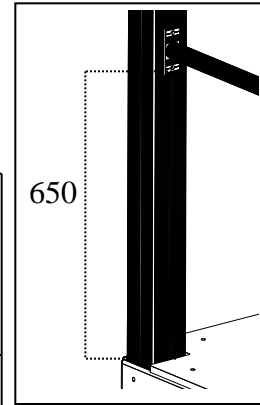
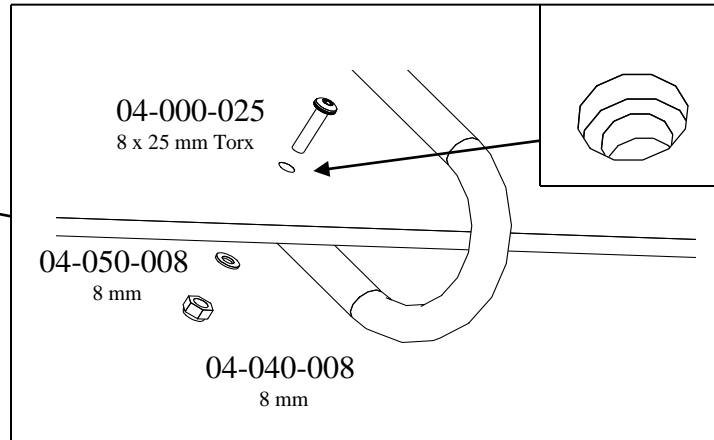
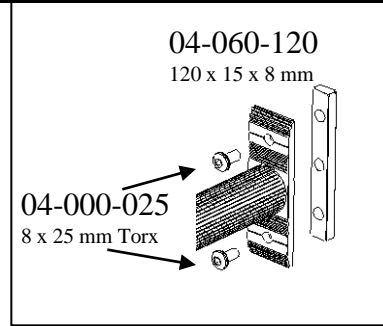
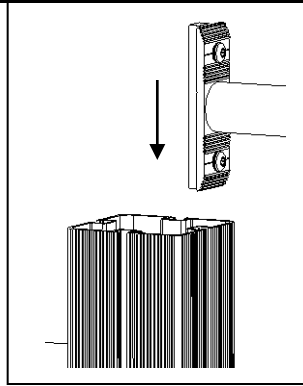
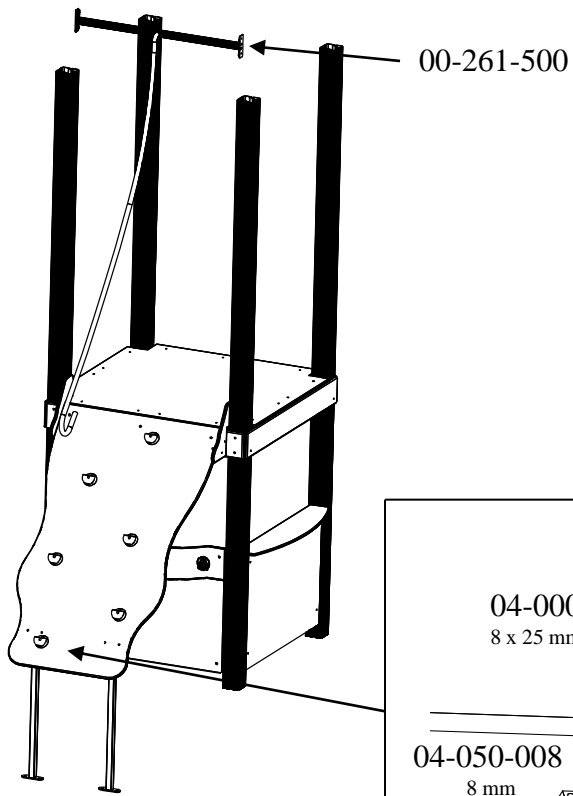

8

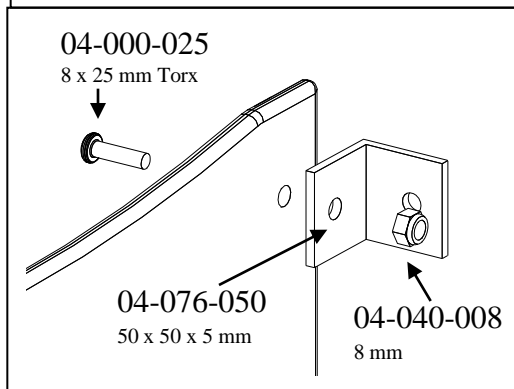
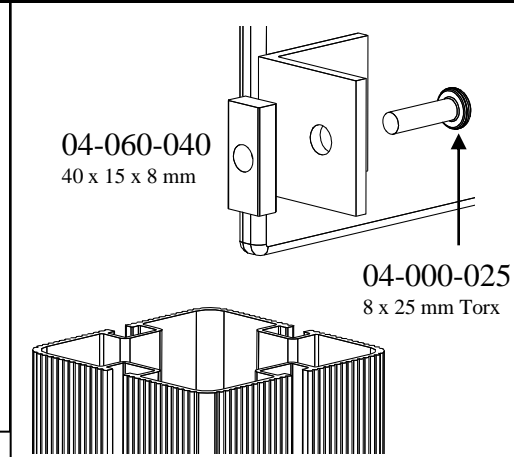
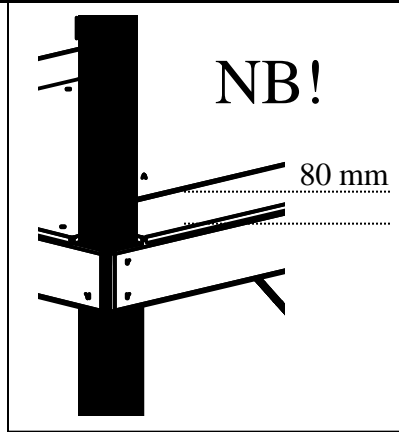
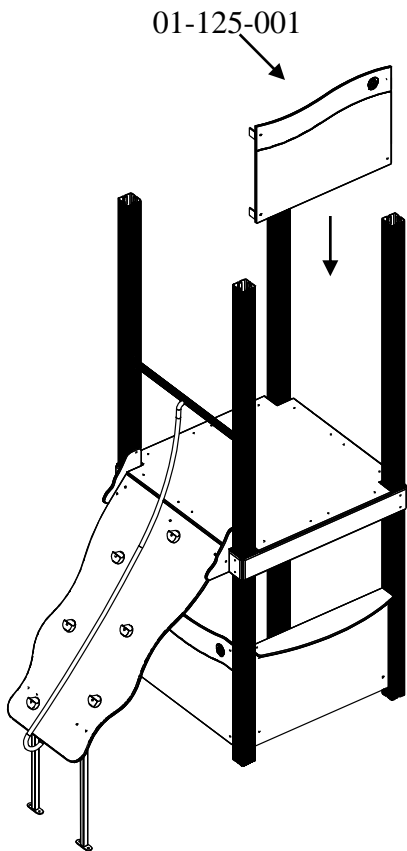

9

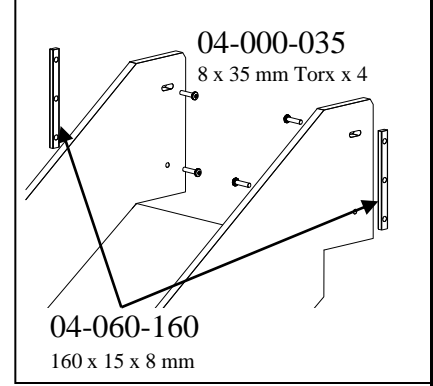
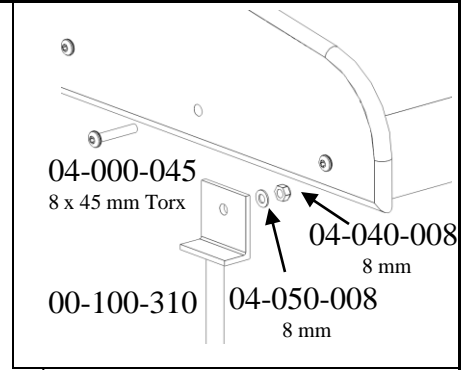
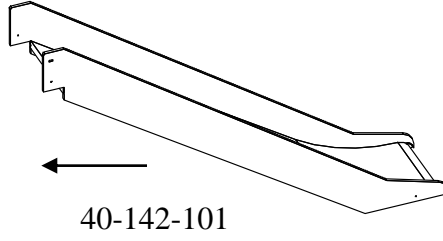
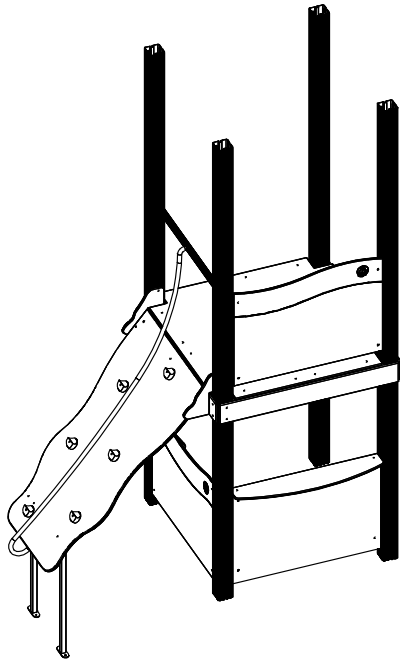

01-126-004

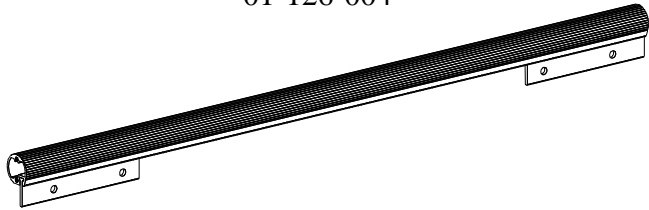

11

04-030-011
8 x 11mm

04-030-011
8 x 11mm



01-126-003

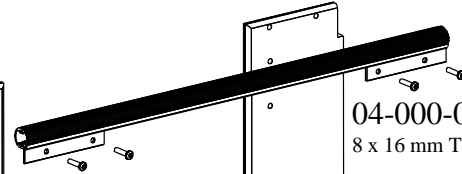

04-000-016
8 x 16 mm Torx

04-000-016
8 x 16 mm Torx

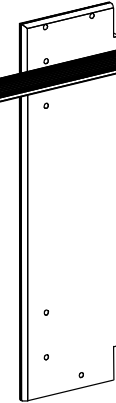

01-126-003

12

04-000-035
8 x 35 mm Torx

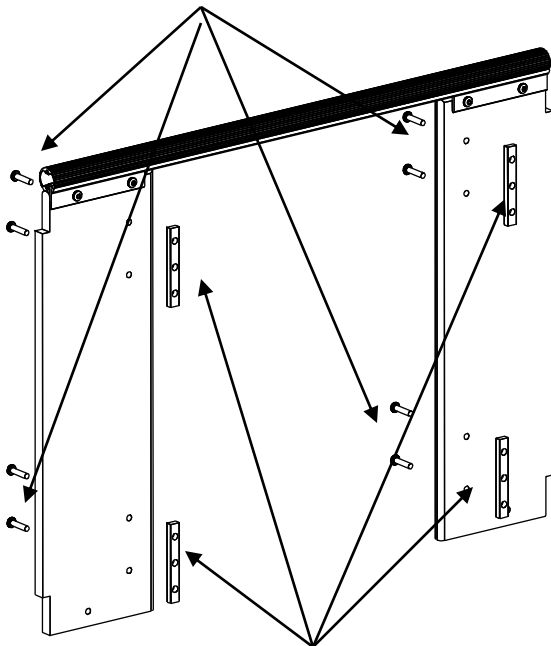

04-060-120
120 x 15 x 8 mm

13

04-000-040
8 x 40 mm Torx

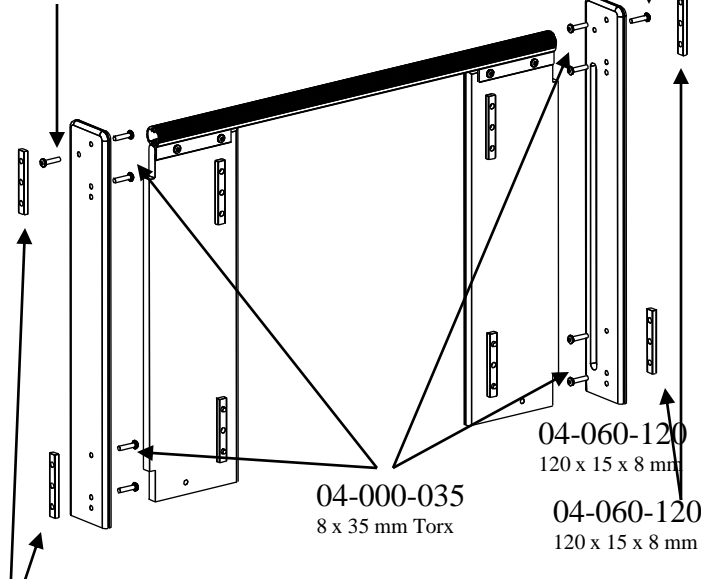

04-060-120
120 x 15 x 8 mm

14

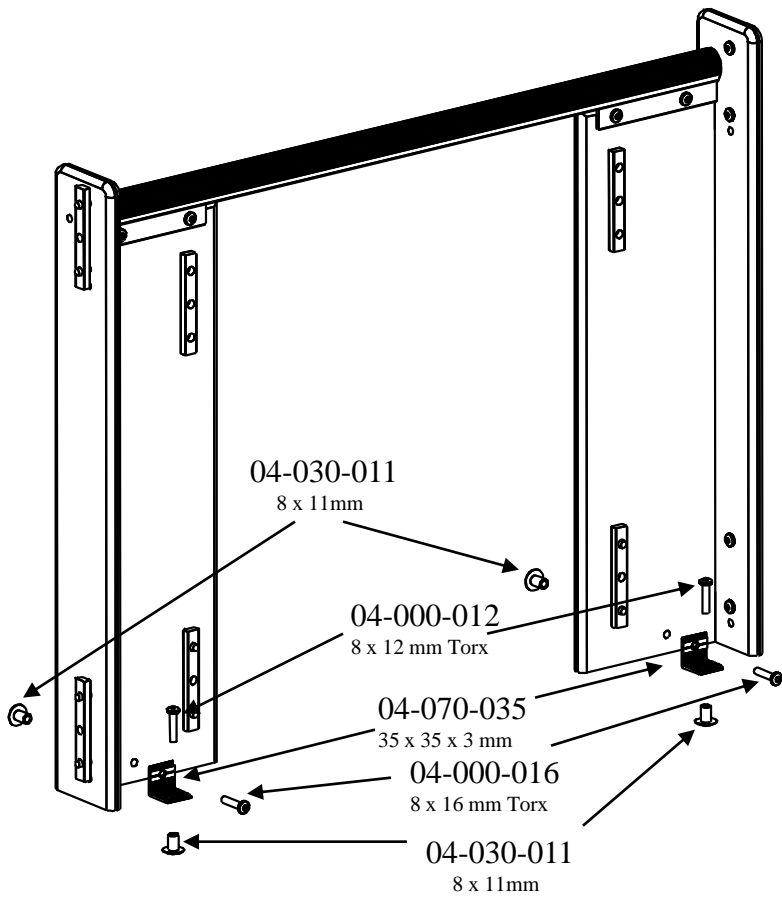

15

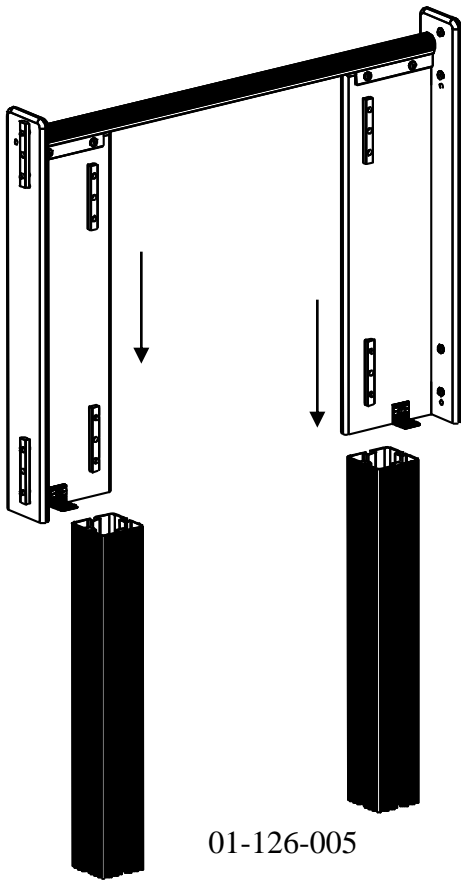

16

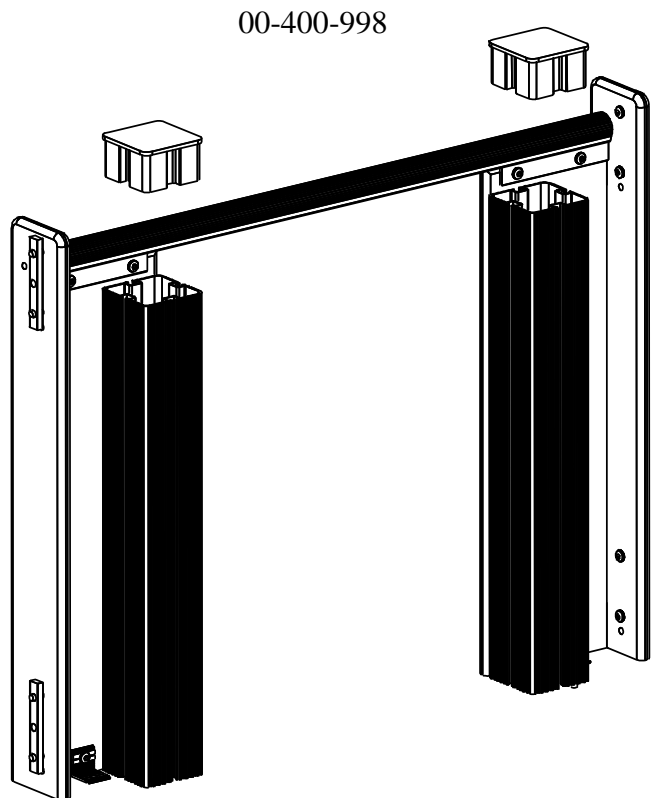

17

01-400-220

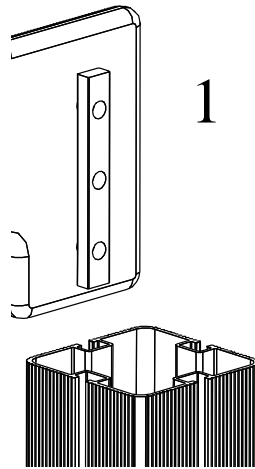
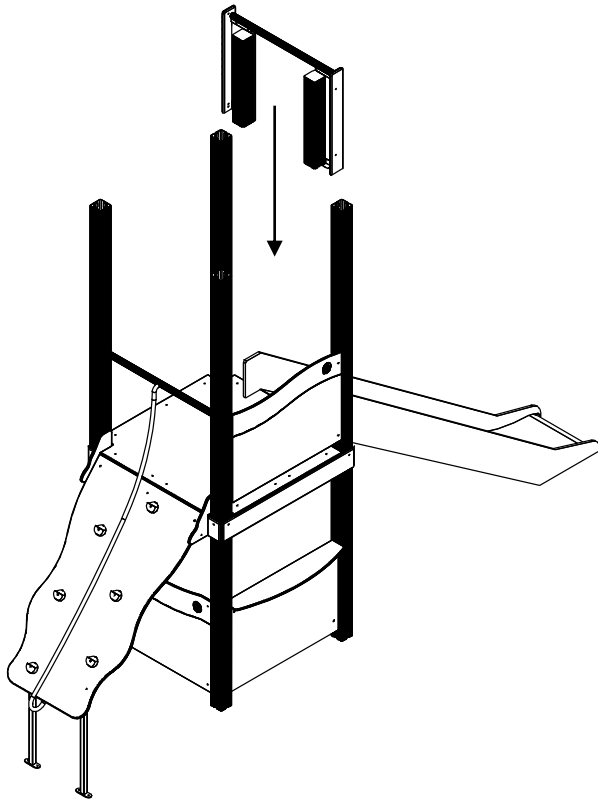

1

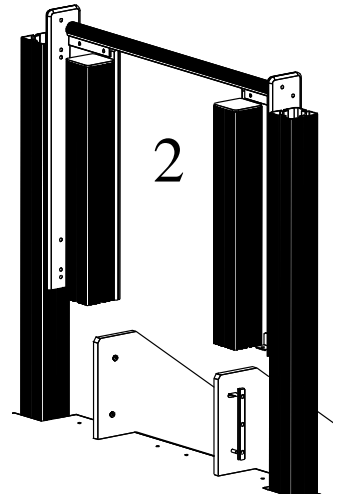

2

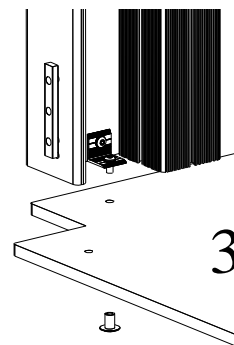

3

- (N) Med bruk av betong
- (UK) With use of concrete
- (S) Med bruk av betong

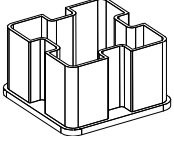
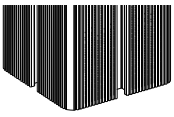

00-400-997

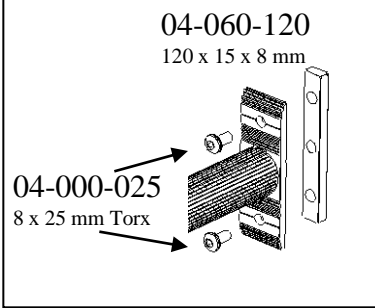
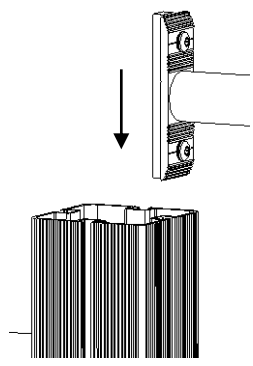

00-400-150

01-400-078

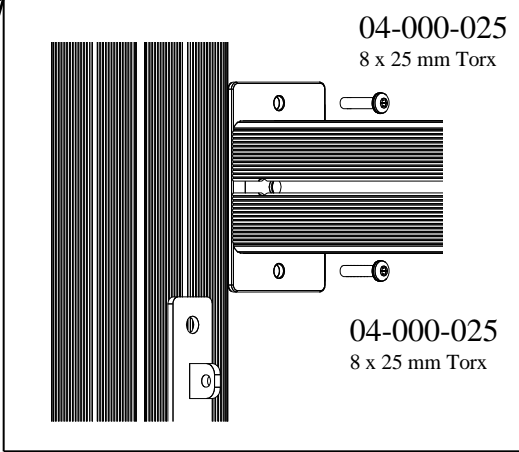

01-400-082

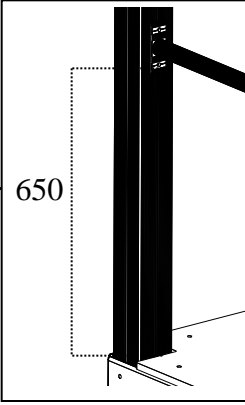

01-400-079

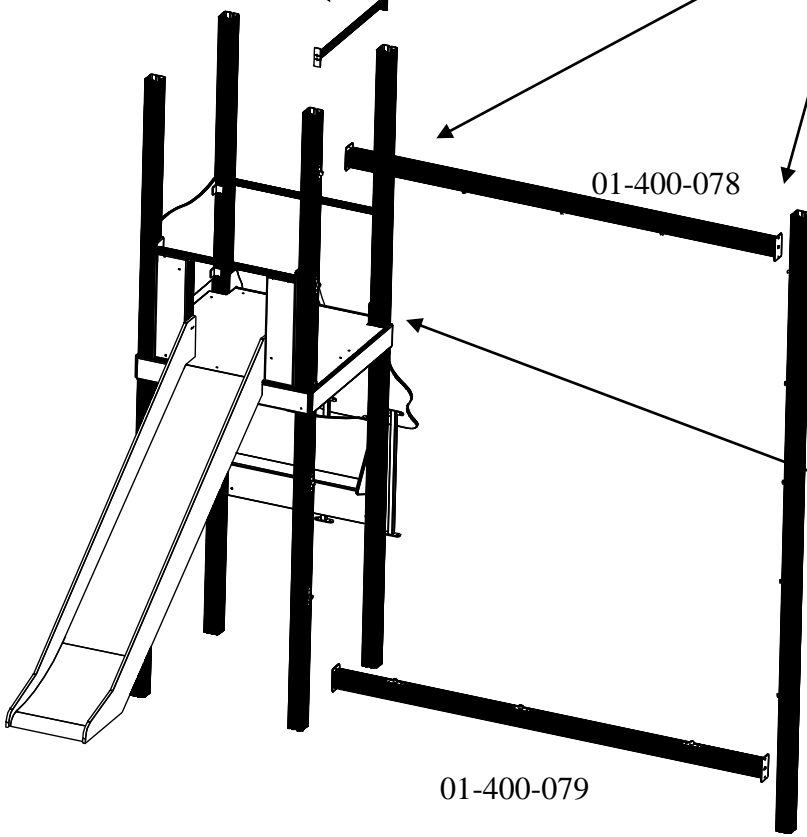

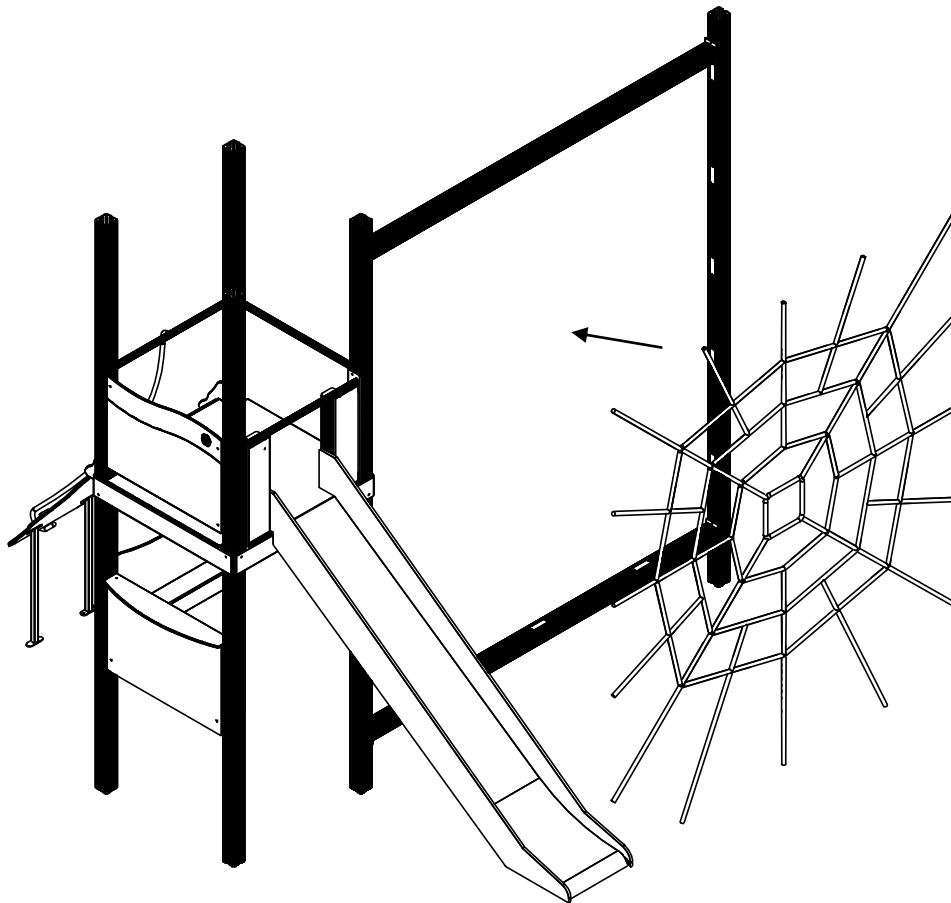
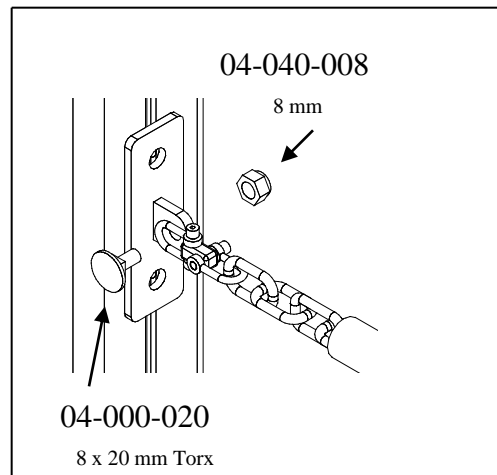

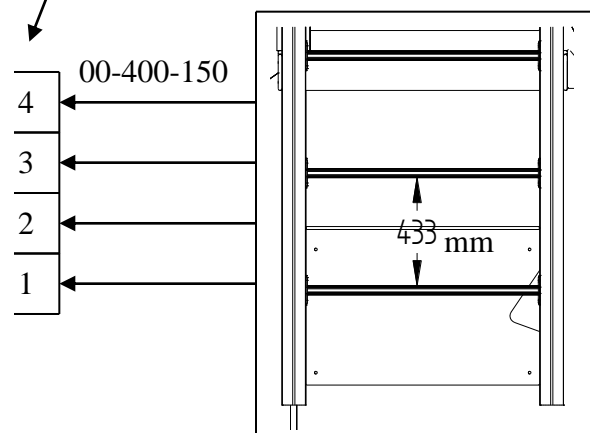
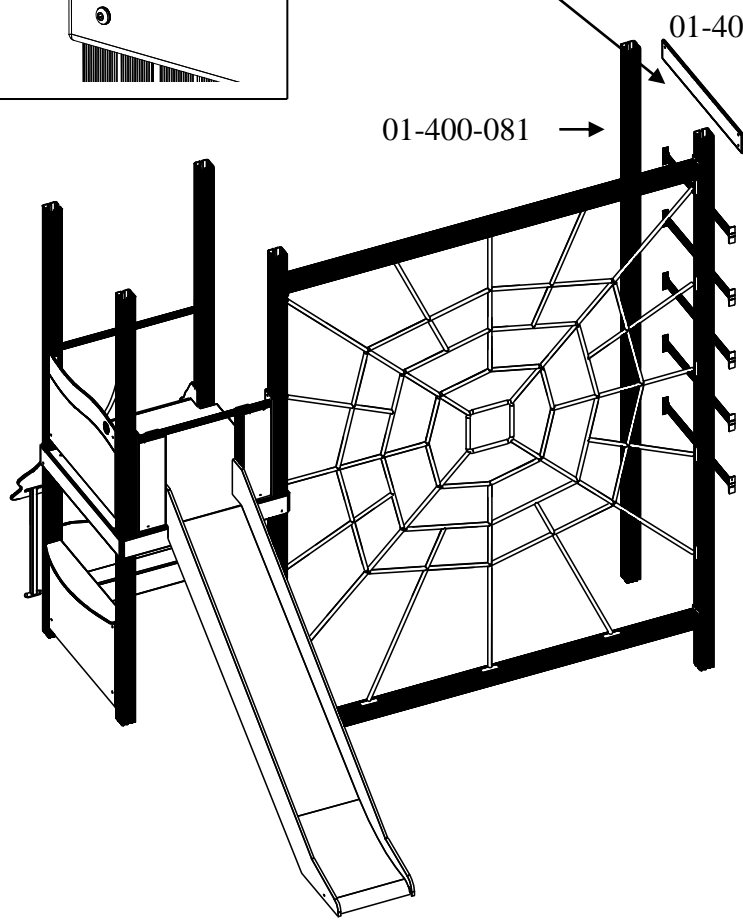
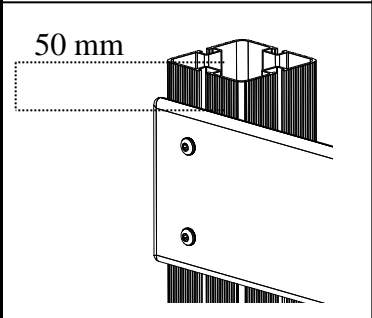
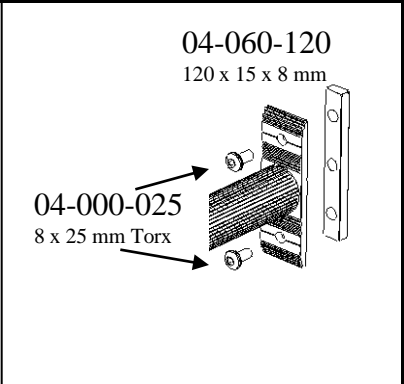
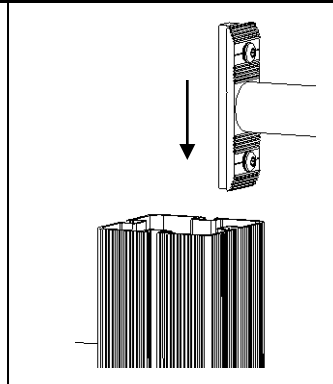
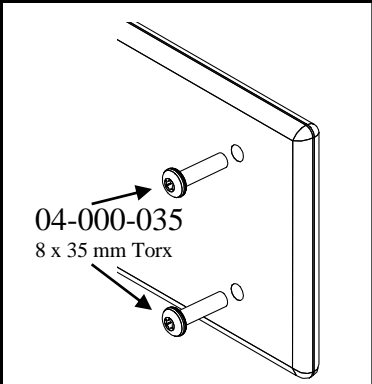

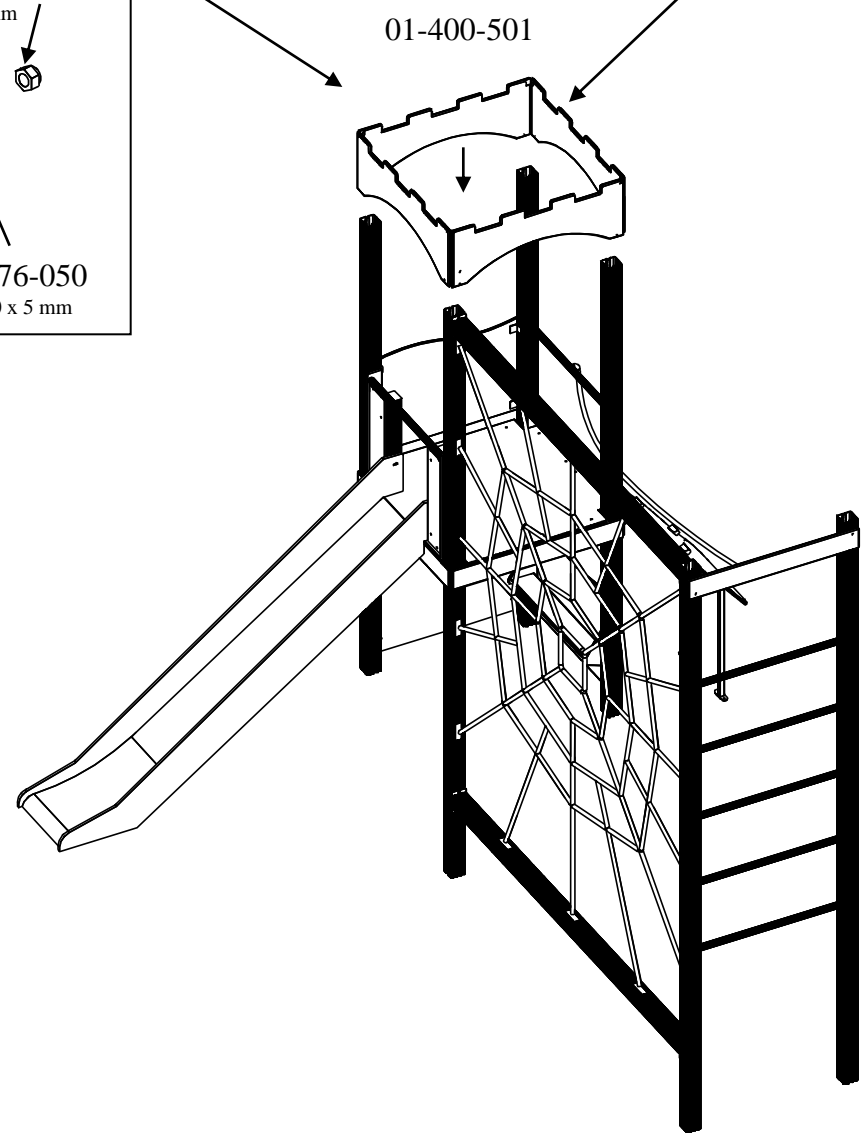
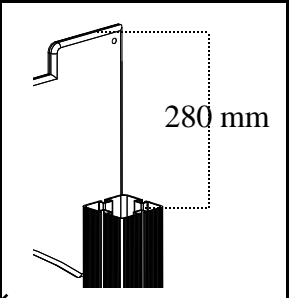
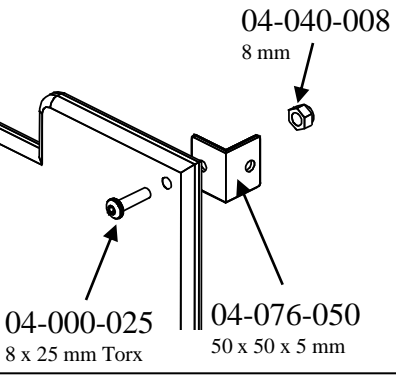
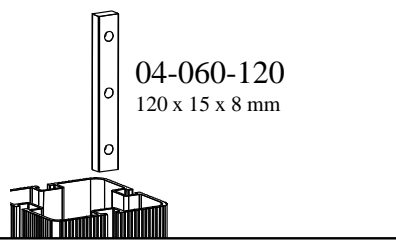
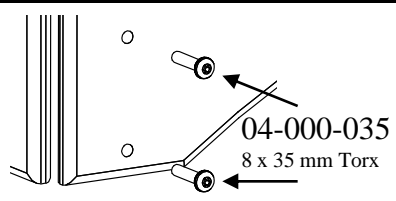

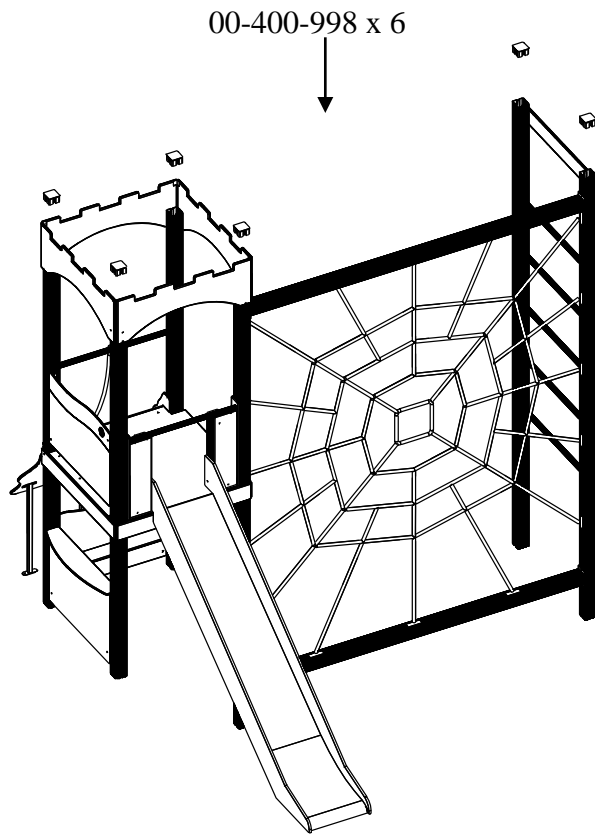

23

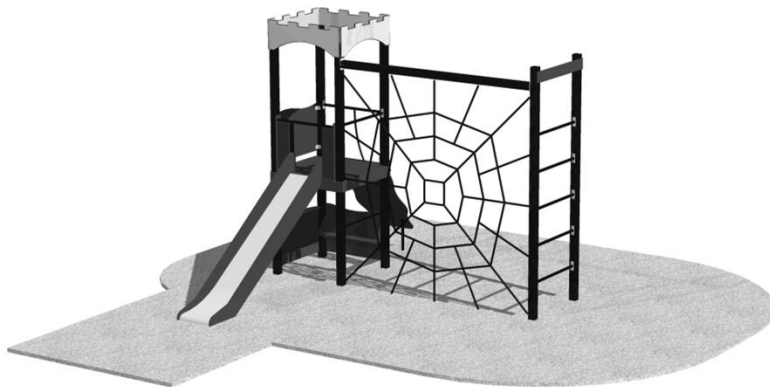
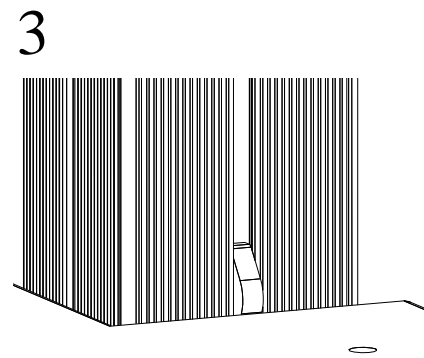
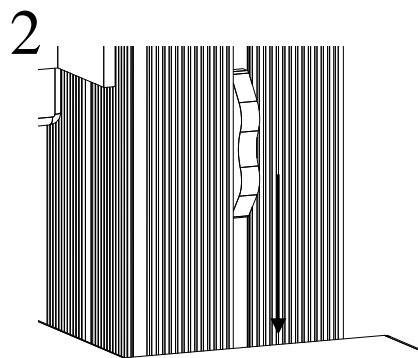
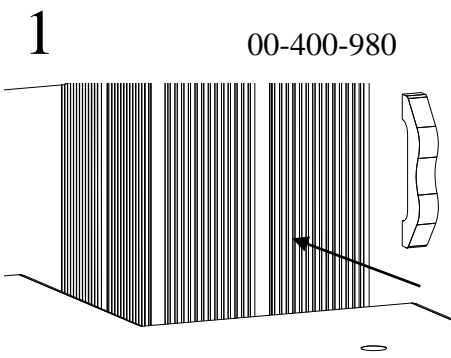

24

N

- ▣ Påse at fallunderlag er lagt i henhold til gjeldende regler eller vår anbefaling
- ▣ Fjern alle monteringshjelpemidler (rester av betong, planker, paller, plast, og lignende)
- ▣ Før utstyret tas i bruk, sjekk at det ikke er hektefare for anorakksnorer og lignende noen steder på lekeapparatet.

NB! Bør stå i 2-3 dager før bruk når forankring støpes.

UK

- ▣ Make sure the area and depth of safer surfacing are according to the current standard, or to the manufacturer's recommendation
- ▣ Make sure all tools and surplus materials are removed before play begins











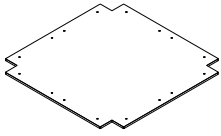

PS! When complete, allow 2-3 days for the concrete to set before use.

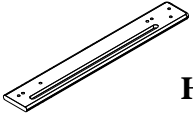

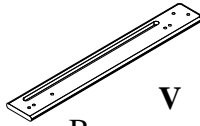

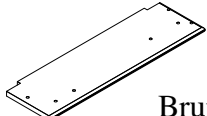
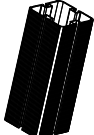

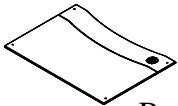
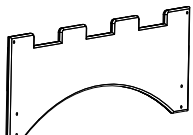
S

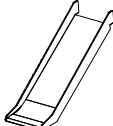
- ▣ Kontrollera att fallunderlag är utlagt enligt gällande regler eller vår rekommendation
- ▣ Ta bort alla monteringshjälpmedel (rester av betong, plankor, pallar, plast och liknande)
- ▣ Innan lekredskapet används, kontrollera att anoracksnoddar eller kläder/delar av kläder eller liknande inte kan fastna i några delar på redskapet.

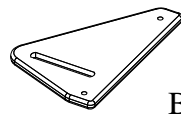
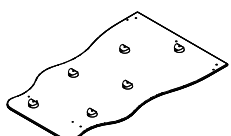

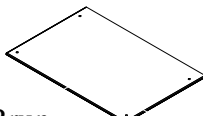

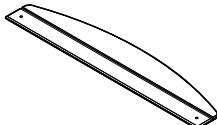

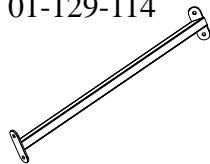
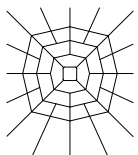
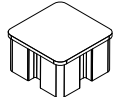

- ▣ OBS! Bör stå i 2-3 dagar innan användning när det gjuts

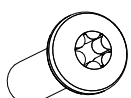
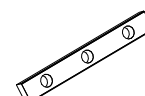
(N)
(UK)
(S)









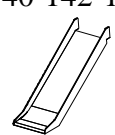

Komponenter Components Komponenter	Dimensjon Dimension Dimension	Ant Qty Ant	Lev Lev	Komponenter Components Komponenter	Dimensjon Dimension Dimension	Ant Qty Ant	Lev Lev
01-400-078 	2815 x 95 x 95 Inkl.Beslag	1		00-400-101 	1130 x 145 x 15	5	
01-400-079		1		Grønn			
01-400-081 	4000 x 95 x 95	1		00-400-300 	1160 x 1160 x 15	1	
01-400-082 	4000 x 95 x 95 Inkl.Beslag	1		01-126-001 	750 x 107,5 x 18	1	
01-400-083 	4000 x 95 x 95 Inkl.Beslag	1		01-126-002 	750 x 107,5 x 18	1	
01-400-084 	4000 x 95 x 95	3		01-126-003 	674 x 205 x 18	2	
01-126-005 	640 x 95 x 95	2		01-126-004 	904 x 61 x 37	1	
01-125-001 	940 x 686 x 12	2		01-400-502 	1130 x 400 x 18	4	
00-100-310 	512 x 120	2		40-142-101 	0,5m x 3m	1	
				Grønn			

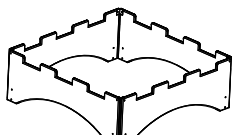



N UK S	Komponenter Components Komponenter	Dimensjon Dimension Dimension	Ant Qty Ant	Lev Lev Lev	Komponenter Components Komponenter	Dimensjon Dimension Dimension	Ant Qty Ant	Lev Lev Lev
	00-400-150 	940 x 120 x 40	6		01-400-381  Brun 01-400-382	300 x 194 x 12	1	
	01-129-112 	1480 x 910 x 15	1		01-400-379  Grønn	930 x 150 x 12	1	
	01-129-113 	282 x 263 x 15	2		01-125-013  Brun	940 x 630 x 12	1	
	00-261-500 	940 x 120	1		01-125-014 	940 x 195 x 12	1	
	04-080-004 	910 x 40 x 33	1					
	01-129-114 	810 x 120 x 40	2					
		3295 x 2815	1					
	00-400-998 	55 x 95 x 95	8					
	00-400-997 Med hull	55 x 95 x 95	6					

N
UK
S



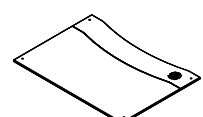







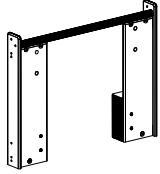

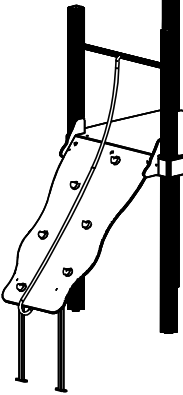



Bolter/skruer Bolts/Screws Komponenter	Dimensjon Dimension Dimension	Ant Qty Ant	Lev Lev	Bolter/skruer Bolts/Screws Bultar/Skruvar	Dimensjon Dimension Dimension	Ant Qty Ant	Lev Lev
	04-000-020 8 x 20 mm Torx	16			04-060-120 120 x 15 x 8 mm	12	
	04-000-025 8 x 25 mm Torx	44					
	04-000-030 8 x 30 mm Torx	2			04-060-040 40 x 15 x 8 mm	8	
	04-000-035 8 x 35 mm Torx	24					
	04-000-012 8 x 12 mm Torx	1					
	04-030-016 8 x 16 mm	2			00-400-980	4	
	04-040-008 8 mm	24				Spesial til gulv 04-075-050 50 x 50 x 5 mm	2
	04-050-008 8 mm	2				04-076-050 50 x 50 x 5 mm	10

Boltepakker for / Boltpackage for / Bultpaket för 11-145-157

40-142-101 	 04-060-160 160 x 15 x 8 mm	2	01-400-501 	 04-060-120 120 x 15 x 8 mm	8
	 04-000-035 8 x 35 mm Torx	4		 04-000-025 8 x 25 mm Torx	8
	04-000-045 8 x 45 mm Torx	2		 04-000-035 8 x 35 mm Torx	16
	 04-040-008 8 mm	2		 04-040-008 8 mm	8
Antall Number Antal	Monteringsanvisning Assembly Instructions Monteringsanvisning	1	Antall Number Antal	 04-076-050 50 x 50 x 5 mm	4

01-125-001 	 04-060-040 40 x 15 x 8 mm	4 X 2	
	 04-000-025 8 x 25 mm Torx	8 X 2	
	 04-076-050 50 x 50 x 5 mm	4 X 2	
	 04-040-008 8 mm	4 X 2	
Antall Number Antal			

Sign. _____







<p>01-400-220</p> 	 <p>04-060-120 120 x 15 x 8 mm</p>	8	<p>01-129-110</p> 	 <p>04-060-120 120 x 15 x 8 mm</p>	4	
	<p>04-000-012 8 x 12 mm Torx</p>	2		<p>04-000-025 8 x 25 mm Torx</p>	5	
	<p>04-000-016 8 x 16 mm Torx</p>	6		<p>04-000-030 8 x 30 mm Torx</p>	8	
	 <p>04-000-035 8 x 35 mm Torx</p>	16		 <p>04-000-035 8 x 35 mm Torx</p>	4	
	<p>04-000-045 8 x 45 mm Torx</p>	2		<p>04-000-040 8 x 40 mm Torx</p>	3	
	 <p>04-090-001 8 mm</p>	2		<p>04-000-045 8 x 45 mm Torx</p>	2	
	 <p>04-070-035 35 x 35 x 3 mm</p>	2		 <p>04-040-008 8 mm</p>	9	
	 <p>04-030-011 8 x 11mm</p>	8		 <p>04-070-035 35 x 35 x 3 mm</p>	2	
	 <p>04-050-008 8 mm</p>	4		 <p>04-030-016 8 x 16 mm</p>	3	
	 <p>04-090-002</p>	4		 <p>04-050-008 8 mm</p>	9	
	<p>Monteringsanvisning Assembly Instructions Monteringsanvisning</p>				 <p>04-090-001</p>	2
	<p>Antall Number Antal</p>	<p>01-400-220</p>		1		

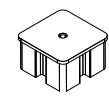



Forankring / Foundations / Markförankring



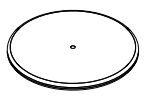

00-003-003

N Er bestilt Ikke bestilt
 UK In order Not in order
 S Bestållt Ej bestållt

00-400-997 	-6	
---	----	--

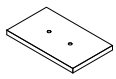
 00-003-100  00-003-101  00-003-102					 04-000-035 8 x 35 mm Torx	18	
					 04-050-008 8 mm	18	
				6	 04-060-120 120 x 15 x 8 mm	12	

00-003-103 					 04-000-040 8 x 40 mm Torx	0	
					 04-040-008 8 mm	0	
				0	 04-050-008 8 mm	0	

Eller Or Eller 00-003-105  00-003-106 					 04-010-035 10 x 35 mm	8	
					 04-040-010 10 mm	8	
				4	 04-050-010 10 mm	8	