



Monteringsanvisning



Assembly Instructions



Monteringsanvisning

Produkt nr. / Product no. / Produkt nr.

11-145-250

Ordr. nr. _____

Dato. _____

Sign. _____

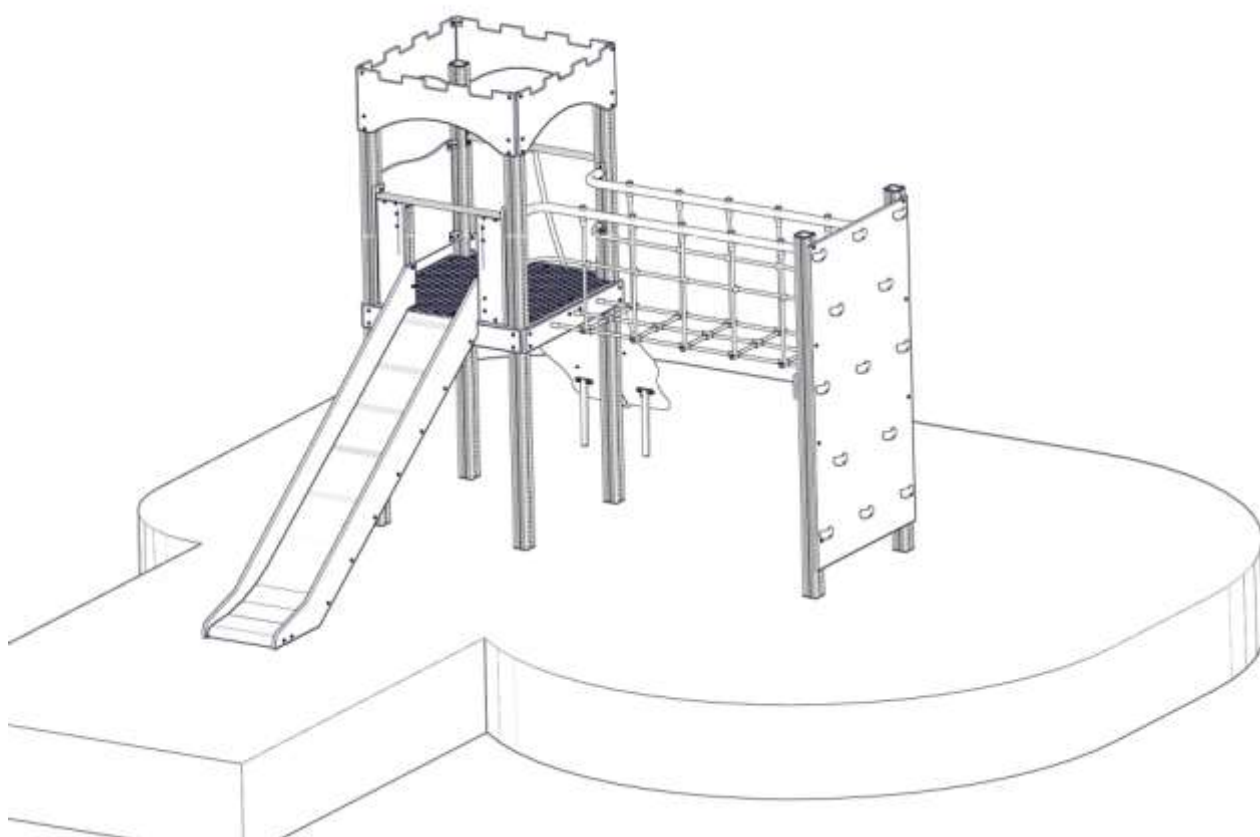

Søve Lekemiljø AS
3830 Ulefoss - Norway
Tlf: +47 35 94 65 65
www.sove.no



Søve AB
EA Rosengrensgatan 32
421 31 Västra Frölunda
Phone: +46 (0)31 773 97 00
www.sove.se

Monteringstips / Assembly Advice / Monteringsstips

N

- Les monteringsanvisningen nøye før montering.
- Monter elementene i rekkefølgen som vist.
- Boltene bør ikke skrues for hardt til før alt er montert, vatret og loddet. Skru så boltene til.
- NB! Ved bruk av drill, kan boltene ryke.
- På grunn av at solen kan gjøre rutsjeplaten veldig varm, bør rutsjebanens utløp vende mot nord-øst eller nord-vest.
- Er lekeutstyret plassert i naturlige ferdselstraséer må området sikres mot gjennomgang.
- Innspringningshinder bør vurderes rundt lekeapparater hvor det er stor bevegelse, f.eks. ved huskestativ.
- Det bør være fritt innsyn til lekeutstyr som er beregnet for barn under 3 år.

NB! Under monteringsarbeidet må utstyr, som ikke er forankret forsvarlig i bakken, sikres slik at det ikke velte.

Området må avstenges under montering av apparatene med sperrebånd eller lignende.

UK

- Read the instruction carefully before assembling the play unit..
- Assemble the components in the sequence shown in these instructions.
- Fixings must not be fully tightened during assembly. Before casting the foundations, the structure must be level and plumb, at which point all fixings are tightened.
- PS! If use of drill, the bolts may be wrecked.
- Avoid positioning the slide facing due south because of overheating – ideal positions are facing north-east or north-west.
- Secure the construction-area to prevent people from walking through it.
- Consider installing barriers around play-equipment which gives rise to a lot of activity – i.e.swings.
- Ensure that clear vision is possible across the play area so that supervision is possible from any position, particularly where children under 3 years of age will be playing.

NB! During assembly of the equipment, ensure that all structures are securely propped, especially when left overnight. Also ensure that equipment is supported whilst concrete foundations are setting and enclose the area securely to prevent access.

Monteringstips / Assembly Advice / Monteringsstips

S

- Läs monteringsanvisningen noga före montering.
- Montera delarna i den ordningen som anvisas
- Skruvarna bör inte skruvas för hårt tills allt är monterat, i väg och lodat.











OBS! Används elektrisk skruvdragare, kan bulten gå sönder. Hårdra därför manuellt!

- Solen kan göra att rutchbanan blir väldigt varm. Banans nedfart rekommenderas att vändas i norrlig riktning
- Om lekplatsen placeras vid en gångväg mm bör området säkras mot genomfart av gående och cyklister.
- Insprängningshinder bör placeras runt lekutrustning med stor rörelse, t ex, gungställning.
- Det bör vara fri insyn till lekutrustning beräknat till barn under 3 år.

OBS! Under monteringsarbete bör utrustningen som inte ska förankras i marken, ställs så att den inte kan välta.

Området måste spärras när lekutrustningen byggs upp, med avspärrningsband eller liknande.

Nødvendig verktøy / Tools required / Nödvändiga verktyg

<p>(N)</p> <p>(UK)</p> <p>(S)</p>	<p>(A)</p> 	<p>(B)</p>  <p>Torx Nr 45 High quality</p>	<p>(C)</p> <p>5 mm 6 mm</p> 	<p>(D)</p> 	<p>(E)</p> 
		<p>Metermål Metric measure Tumstoc</p> 	<p>16 V</p> 	<p>Merkebånd Mark ribbon Märkeband</p> 	<p>13 + 17mm</p> 

Nødvendig antall personer / Number of persons required / Lämpligt antal personer





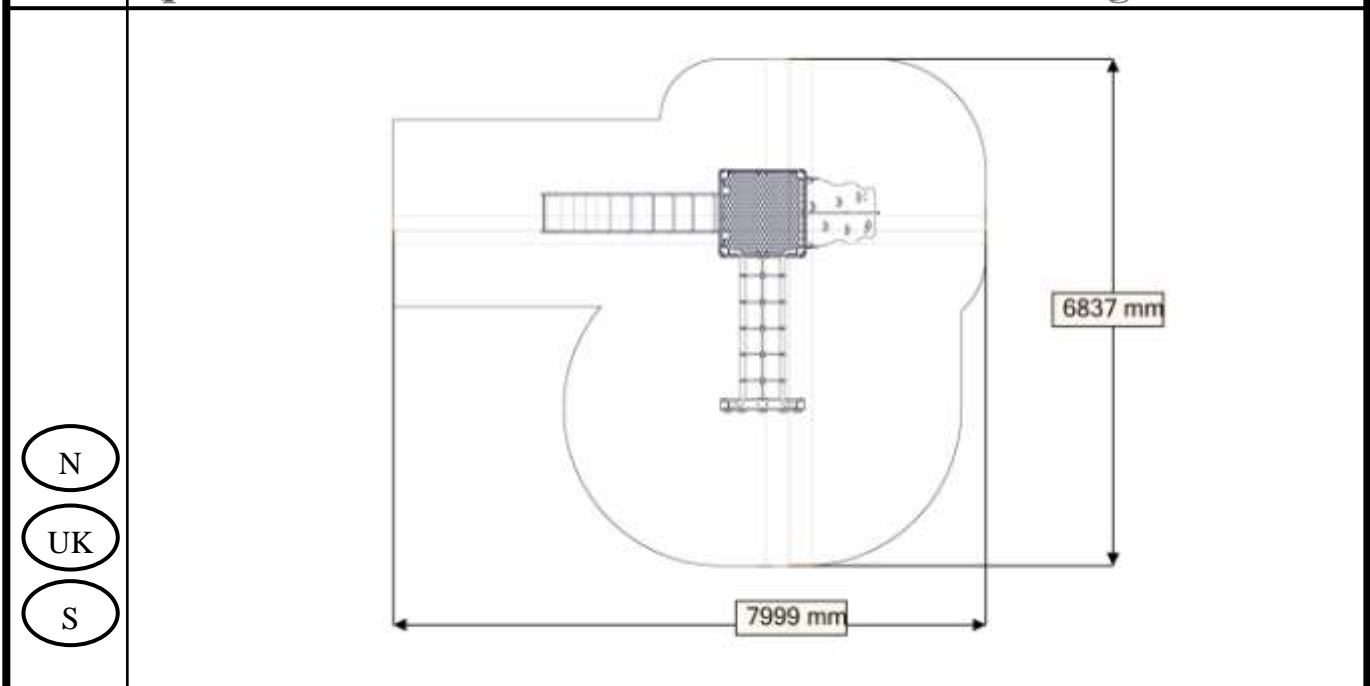











Anbefalt arealbehov ved montering / Recommended working space / Rekommenderad arealbehov vid montering

















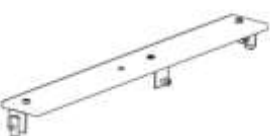

Boltepakker for / Boltpackage for / Bultpaket för

Sign. _____

Stolpe 95x95	Ant= 1	Navn	Artnr/dimensjon	Ant	Lev
		VK95 L=3235 600-2635 (4) VK95 L=2900 600-2300(2)	00-400-009 00-400-010	4 2	
		Stolp ende (1)	00-400-998	6	
Portal 01-400-220	Ant= 1	Navn	Artnr/dimensjon	Ant	Lev
		Frontplate (2)	01-126-003	2	
		Side plate H (1) Side plate V (1)	01-126-001 01-126-002	1 1	
		Sperrerør (1)	01-126-004	1	
		Stolpe VK95 (2) L=640	01-126-005	2	
		Stolpende (2)	00-400-998	2	
		Torx M8x16 (6) Torx M8x35 (16) Torx M8x45 (2)	04-000-016 04-000-035 04-000-045	6 16 2	
		Brikke 120 3T (8)	04-060-120	8	
		Vinkel (2) 35x35x3 11mm hull	04-070-036	2	
		Møbelknapp (6) M8-13-17	04-030-011	6	
		Hylesmutter (2) M8 12-38	04-018-060	2	
		Skive M8 (4)	04-050-008	4	











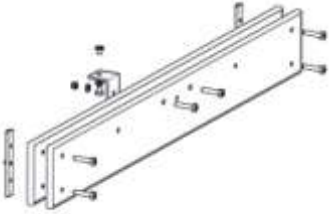

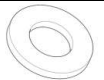

Boltepakker for / Boltpackage for / Bultpaket för

Sign. _____.

Gulv 1160x1160x15	Ant= 1	Navn	Artnr/dimensjon	Ant	Lev
		Gulv (1)	00-400-300	1	
		Vinkel 50x50x4(2) 11mm	04-070-050	2	
		Torx M8x30 (2) Torx M8x12(2)	04-000-030 04-000-012	2 2	
		Møbelknapp (2)	04-030-011	2	
		Plast plug 9-11 mm (16)	04-090-002	16	
		Plug spor (8)	00-400-980	8	
		Skive M8 (4)	04-050-008	4	
		Låsemutter M8	04-040-008	2	
Gulvdel 938x110x15	Ant= 1	Navn	Artnr/dimensjon	Ant	Lev
		Gulv del(1)	00-400-381	1	
		Vinkel 50x50x4(1) 11mm	04-070-050	3	
		Torx M8x30(2) Torx M8x25 (2) Torx M8x12(2)	04-000-030 04-000-025 04-000-012	3 2 1	
		Møbelknapp (1)	04-030-011	1	
		Brikke 50_1T(2)	04-060-050	2	
		Plug spor (2)	00-400-980	2	
		Skive M8 (4)	04-050-008	3	
		LåseMutter M8	04-040-008	3	

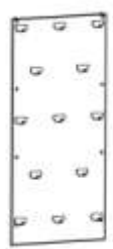









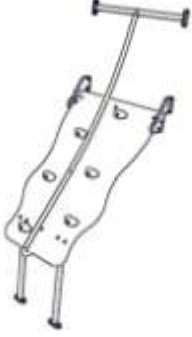



Boltepakker for / Boltpackage for / Bultpaket för

Sign. _____

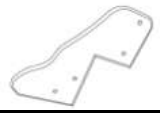
Sprosse 01-400-112 med hull polyfixnett	Ant= 2	Navn	Artnr/dimensjon	Ant	Lev
		Sprosse (2) 1160x145x15 Med hull	01-400-112	4	
		Torx M8x50 (4) Torx M8x45(2) Torx M8x12 (1)	04-000-050 04-000-045 04-000-012	8 4 2	
		Brikke 150 _3T (2) På stolpe	04-060-150	0	
		Møbelknapp (1) M8- 13-17	04-030-011	2	
		Vinkel 50x50x4(1) 11mm hull	04-070-050	2	
		Mutter M8 (1)	04-040-008	2	
		Skive M8 (2)	04-050-008	4	
Sprosse 01-400-108	Ant= 3	Navn	Artnr/dimensjon	Ant	Lev
		Sprosse (1) 1160x145x15	01-400-108	3	
		Torx M8x35 (4)	04-000-035	12	
		Brikke 150 _3T (2) På stolpe	04-060-150	0	
Klatrevegg	Ant= 1	Navn	Artnr/dimensjon	Ant	Lev
		Klatrevegg	00-400-720	1	
		Torx M8x35 (8)	04-000-035	8	
		Brikke 50_1T (8)	04-000-050	8	









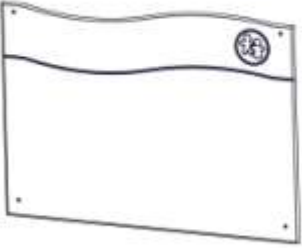
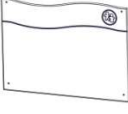

Boltepakker for / Boltpackage for / Bultpaket för

Sign. _____.

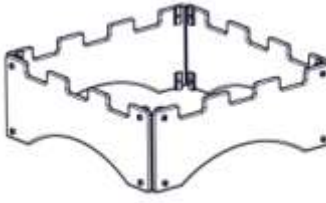
Opptreksplate 01-129-112	Ant= 1	Navn	Artnr/dimensjon	Ant	Lev
		Opptreksplate (1)	01-129-112	1	
		Brikke120 3T(5)	04-060-120	4	
		Torx M8x45(2) Torx M8x40(3) Torx M8x35(4) Torx M8x30(10) Torx M8x25(5)	04-000-045 04-000-040 04-000-035 04-000-030 04-000-025	2 3 8 10 5	
		Skive M8(2)	04-050-008	14	
		Mutter M8(2)	04-040-008	14	
		Stålforankering(2)	01-129-114	2	
		U-profil (1)	02-500-086	1	
		Feste HPL (2)	01-129-113	2	
		Møbelknapp (3)	04-030-016	3	
		Hylsemutter (2)	04-018-060	2	
		Vinkel 35x35x35x3 (2)	04-070-035	2	
		Sperrerør med kjetting	00-126-500	1	
		Fundament plate	00-003-106	2	









Boltepakker for / Boltpackage for / Bultpaket för

Sign. _____

Vegg 940x686x12 01-125-002	Ant= 1	Navn	Artnr/dimensjon	Ant	Lev
		Vegg 940x686x12 (1)	01-125-002	1	
		Brikke 50_1T(4)	04-060-050	4	
		Torx M8x25(8)	04-000-025	8	
		Vinkel 50x50x50x4 (4) 9mm	04-075-050	4	
			04-040-008	4	
Tak borg 01-400-501	Ant= 1	Navn	Artnr/dimensjon	Ant	Lev
		Tak 2230x400x12 (4)	01-400-502	4	
		Brikke 120_3T (8)	04-060-120	8	
		Torx M8x25(24)	04-000-025	24	
		Vinkel 50x50x50x4 (9)	04-075-050	4	
		Låsemutter M8(8)	04-040-008	8	











Boltepakker for / Boltpackage for / Bultpaket för

Sign. _____.

Rutsjebane 1400 40-142-101	Ant= 1	Navn	Artnr/dimensjon	Ant	Lev
		Systembane 1400	40-142-101	1	
		Brikke120 3T(5)	04-060-120	2	
		Torx M8x35(4) Torx M8x45(2) Torzx M8x30(4)	04-000-035 04-000-045 04-000-030	4 2 4	
		Fundamentskive(2) 2H 80	00-003-106	2	
		Skive M8(2)	04-050-008	4	
		Mutter M8(2)	04-040-008	6	
		Stålforankering(2)	00-100-310	2	
		Plast plug 9-11 mm (4)	04-090-002	4	





Boltepakker for / Boltpackage for / Bultpaket för

Sign. _____.

Poly-rett brua	Ant= 1	Navn	Artnr/dimensjon	Ant	Lev	
         		Rør (2)	07-200-027	2		
		Nett brua			1	
		Torx M8x25 (8) Torx M8x30 (8)	04-000-025 04-000-030	8 8		
		Brikke 120_3T (8)	04-060-120	8		
		Plast Rondel (10)	05-300-036	10		
		Plast rondell (20)	05-300-036	20		
		Skive M10 stor polyfix (20)	04-055-036	20		
		Mutter M10 (10) Mutter M8 (6)	04-040-0010 04-040-008	10 6		
		Skive M8	04-055-008	6		

Boltepakker for / Boltpackage for / Bultpaket för

Sign. _____.

Fundament	Ant= 6	Navn	Artnr/dimensjon	Ant	Lev
		Fundament plate(1)	00-003-010	6	
		Fundamentdel1 (1) 4x med VK70 hull 1x med VK95 hull	00-003-010	6	
		Fundament del2 (1) 4x med VK70 hull 1x med VK95 hull	00-003-010	6	
		Torx M8x35(3)	04-000-035	18	
		Brikke 120 3T (1) Brikke 501T(1)	04-060-120 04-060-120	6 6	

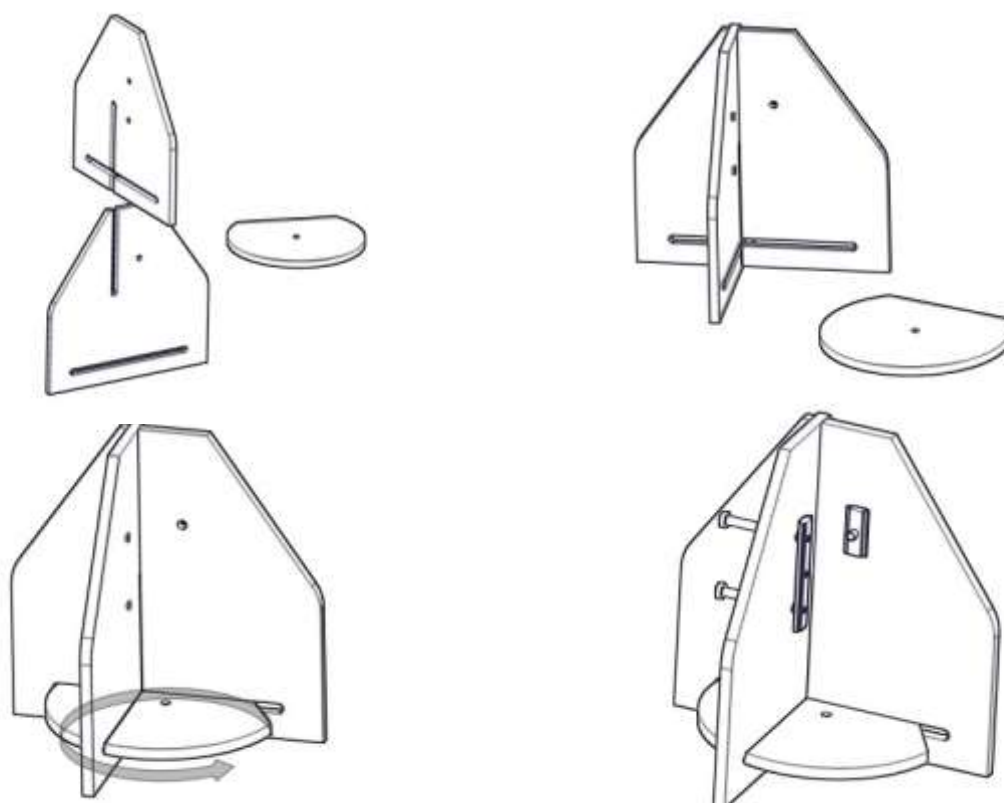

Fundamentering med betong / Foundation concrete / Förankring med betong

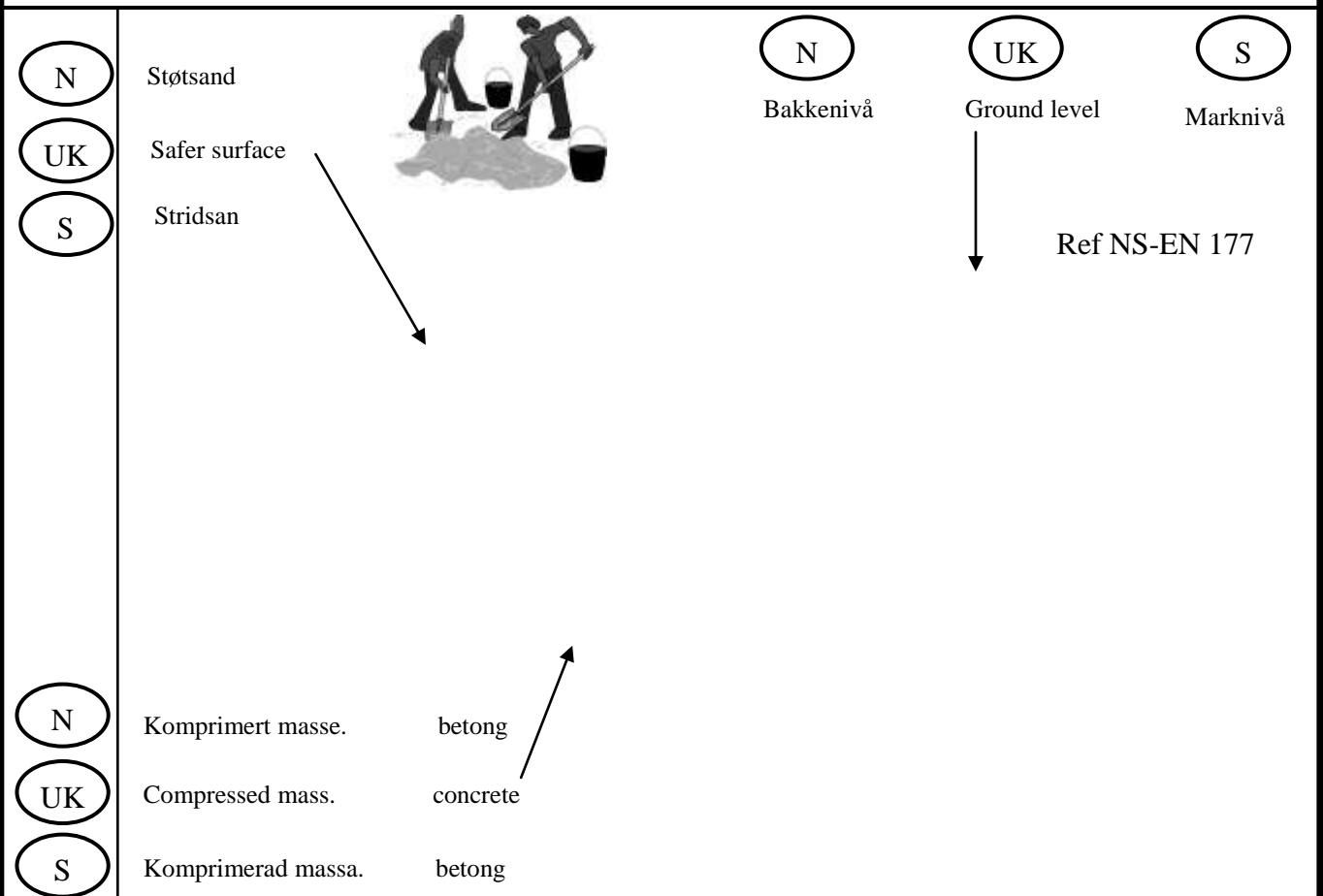

Fundamentering uten betong / Foundation without concrete / Förankring utan betong

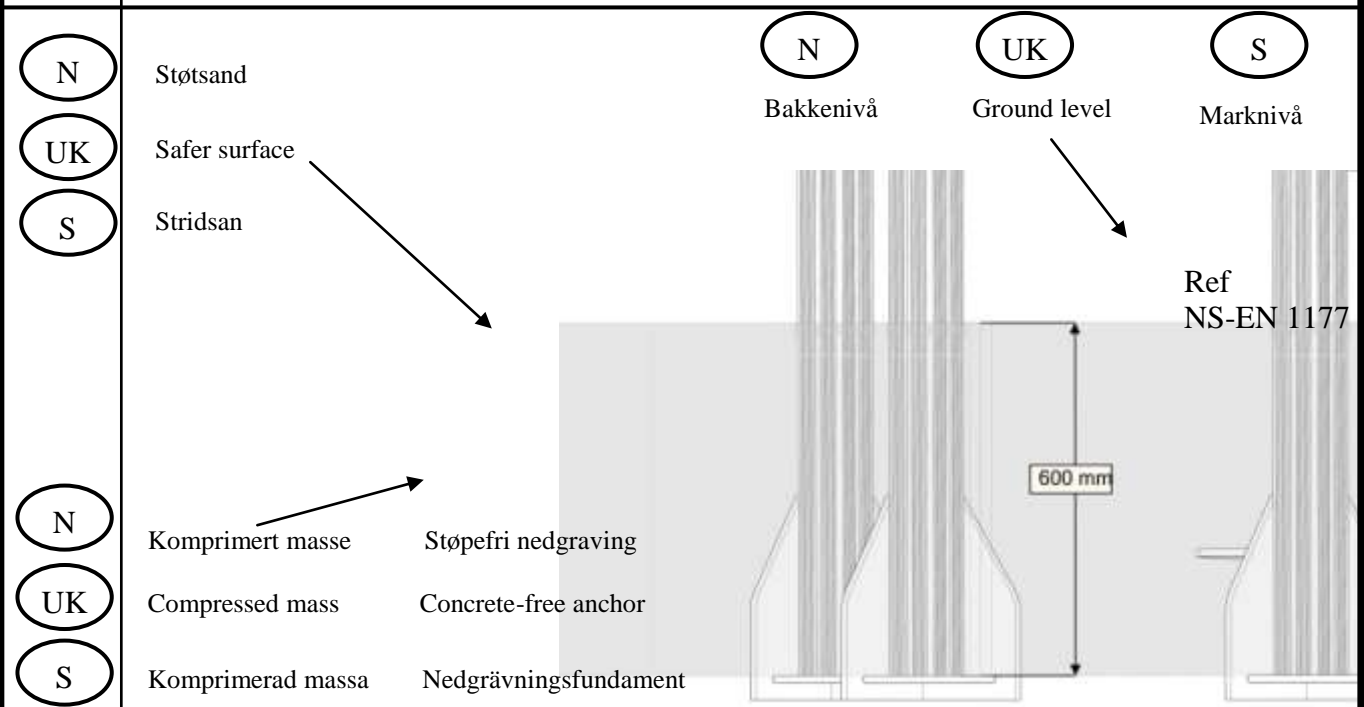

(N) Alle mål er oppgitt i millimeter
 (UK) Scale measured in mm
 (S) Alla mått är i millimeter.

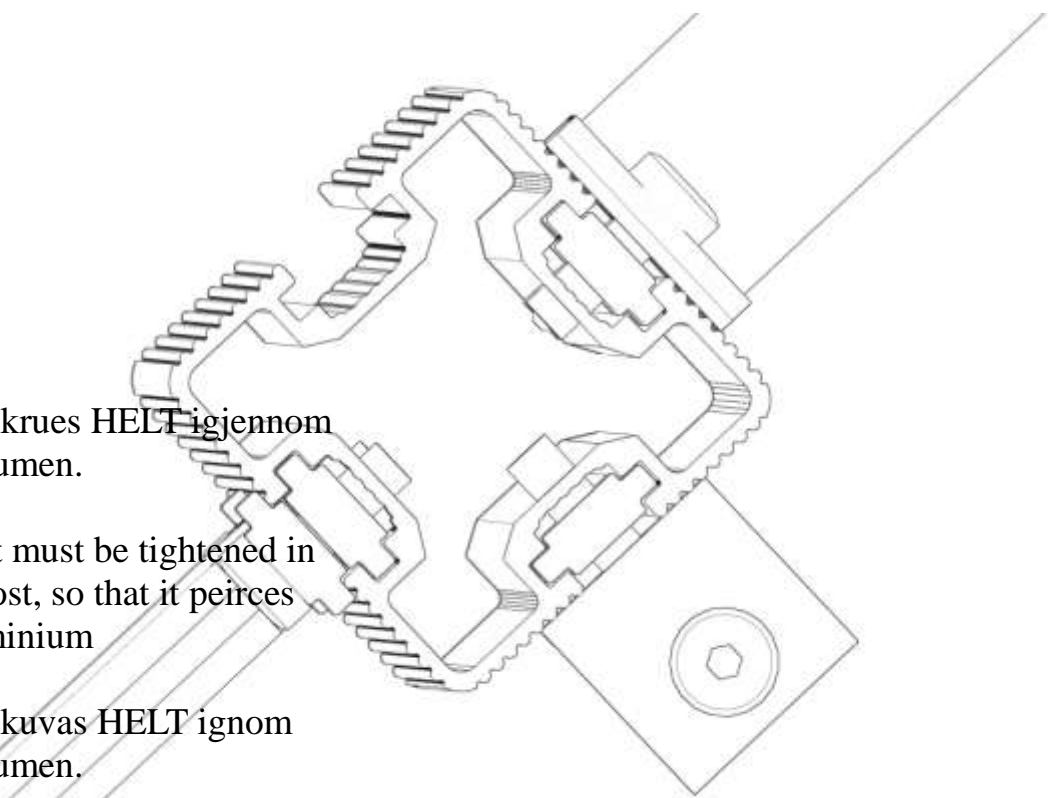
<p data-bbox="113 1556 225 1624">N</p> <p data-bbox="113 1691 225 1758">UK</p> <p data-bbox="113 1848 225 1915">S</p>	 <p data-bbox="225 1579 702 1668">Bolten skrues HELT igjennom aluminiumen.</p> <p data-bbox="225 1713 686 1836">The bolt must be tightened in to the post, so that it peirces the aluminium</p> <p data-bbox="225 1881 662 1971">Bulten skruvas HELT ignom aluminiumen.</p>

Fallhøyder / Free height of fall / Fallhöjder

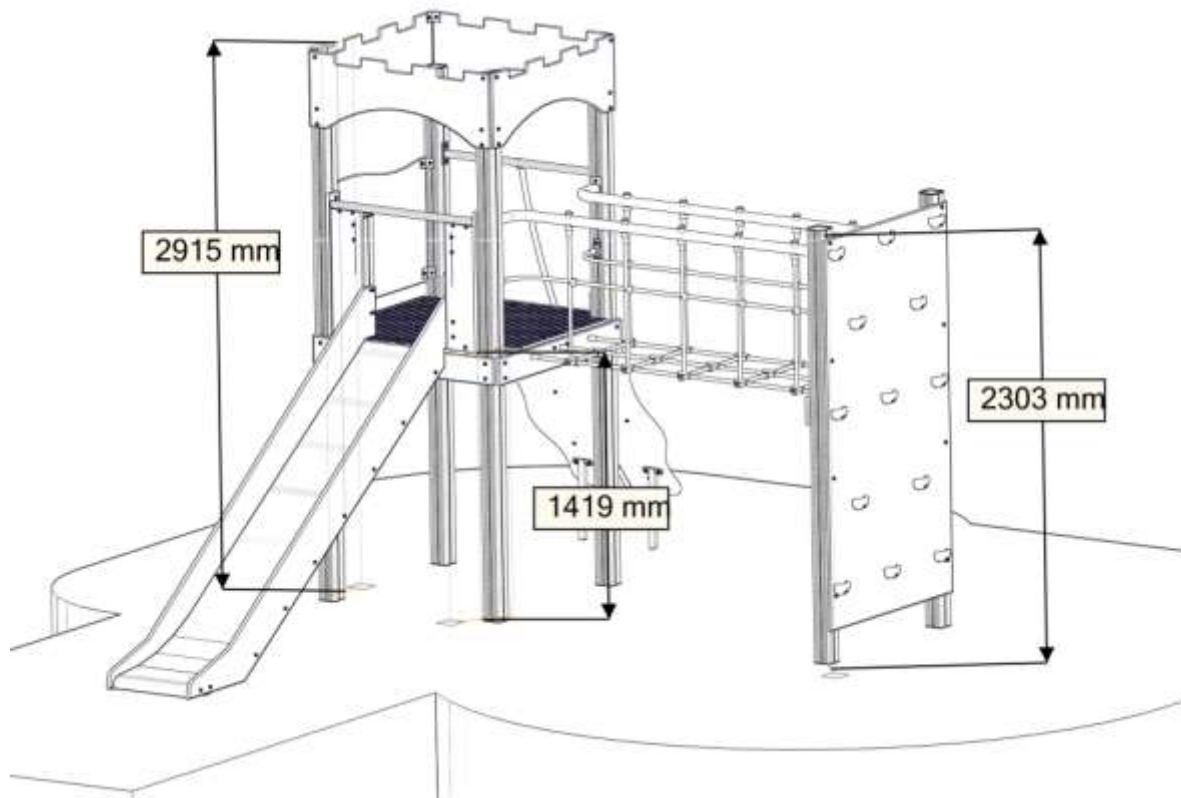

Sikkerhetszone / Safety zone / Säkerhetszon

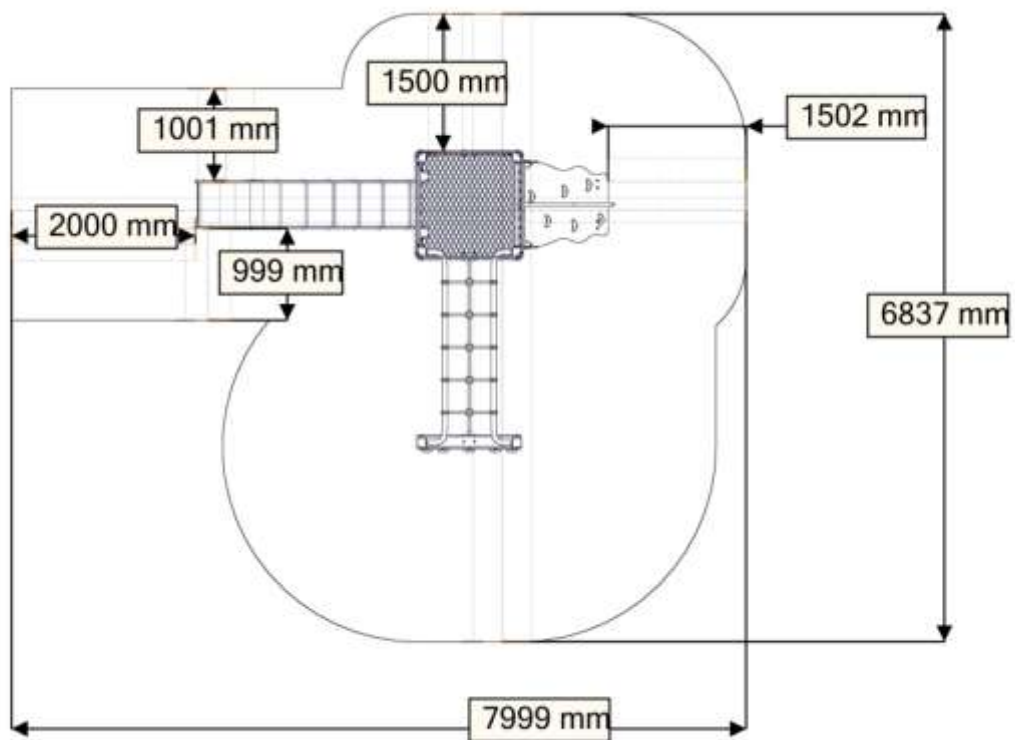

Plassering av forankringer / Ground plan / Placering av förankringar

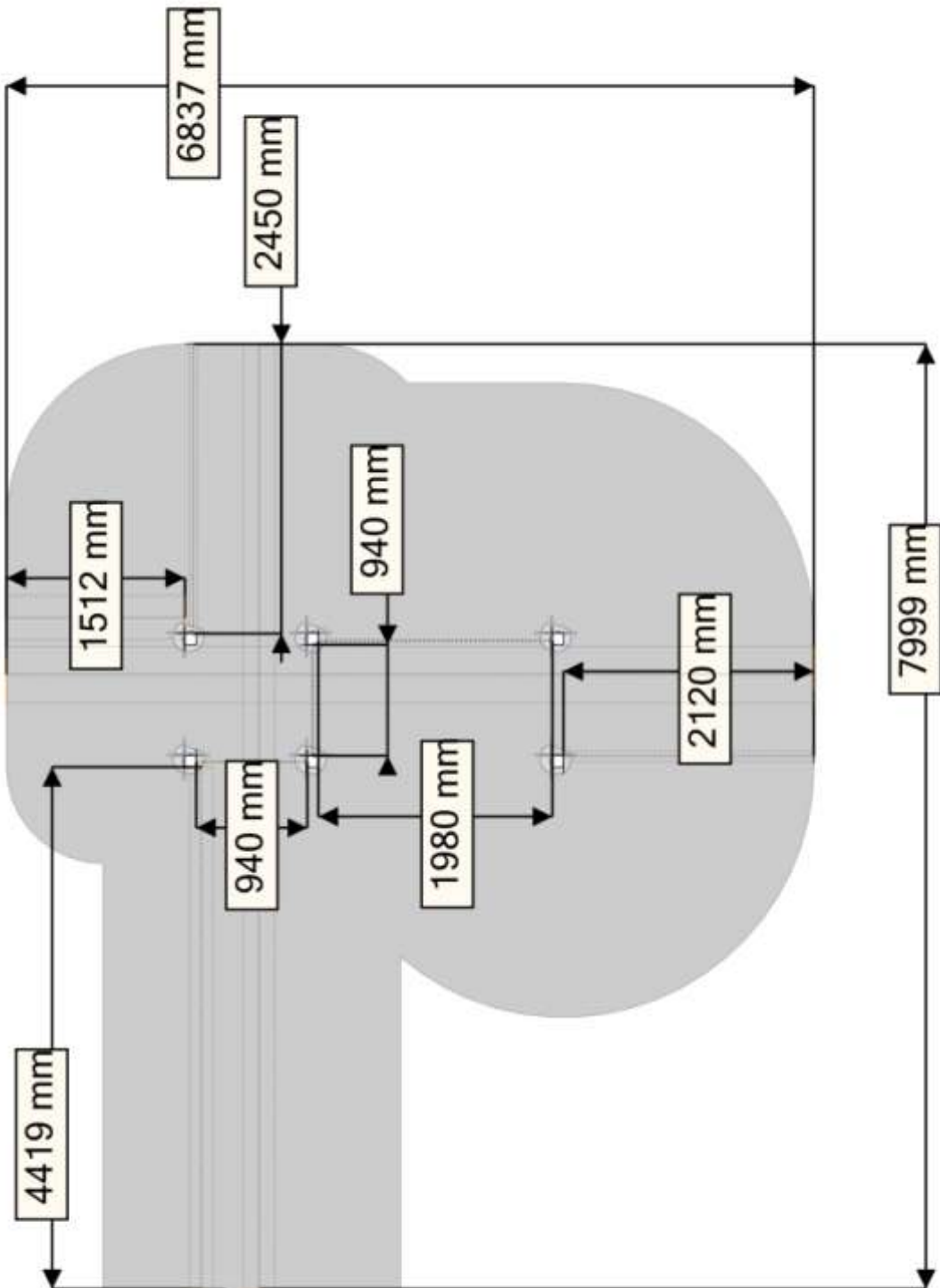

N

Alle mål er oppgitt i millimeter

UK

Scale measured in mm

S

Alla mått är i millimeter.

Montering av lekeapparatet / Assembly instructions / Montering av lekredskapet

6x

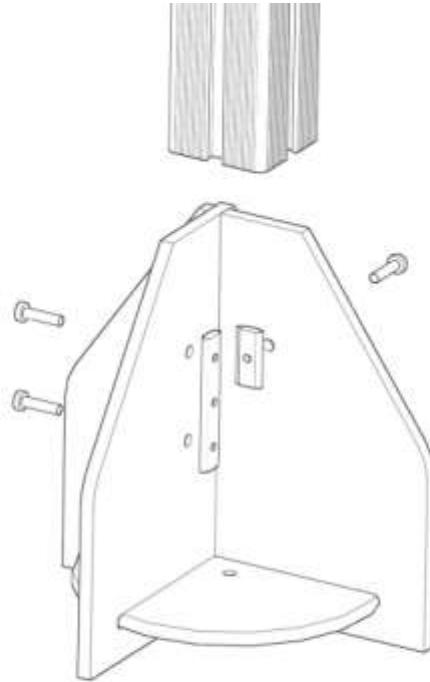

BOM ID	Name	SW Configuration	Artnr (config)	Qty
7	brikke SFA5116-1	120 3T	04-060-120	1
6	brikke SFA5116-2	50 1T	04-060-050	1
2	Fun VK95 a-1	Default	00-003-101	1
1	Fun_VK95_b-1	Default	00-003-100	1

BOM ID	Name	SW Configuration	Artnr (config)	Qty
3	Fun VK95 c-1	Default	00-003-102	1
5	Skive-	M8_stor	04-055-008	3
4	TorxM8-	TXM8x35	04-000-035	3

Brikke påmontert hos Søve

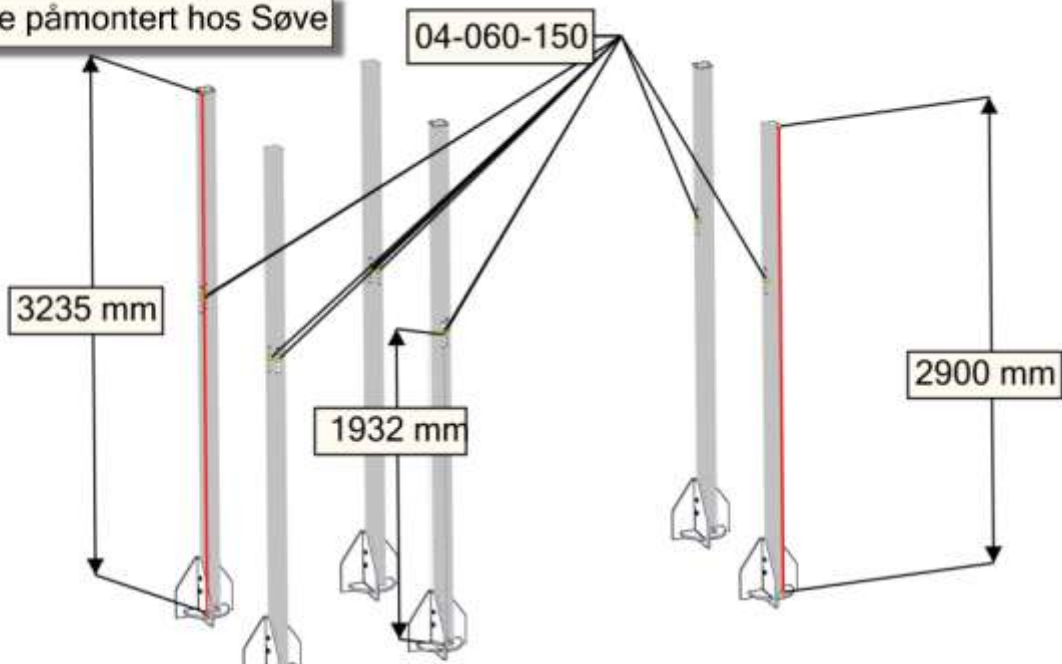

BOM ID	Name	SW Configuration	Artnr (config)	Qty
1	VK95_SFA5117_A-1	600-2635	00-400-009	4
2	VK95_SFA5117_A-1	600-2300	00-400-010	2

Montering av lekeapparatet / Assembly instructions / Montering av lekredskapet

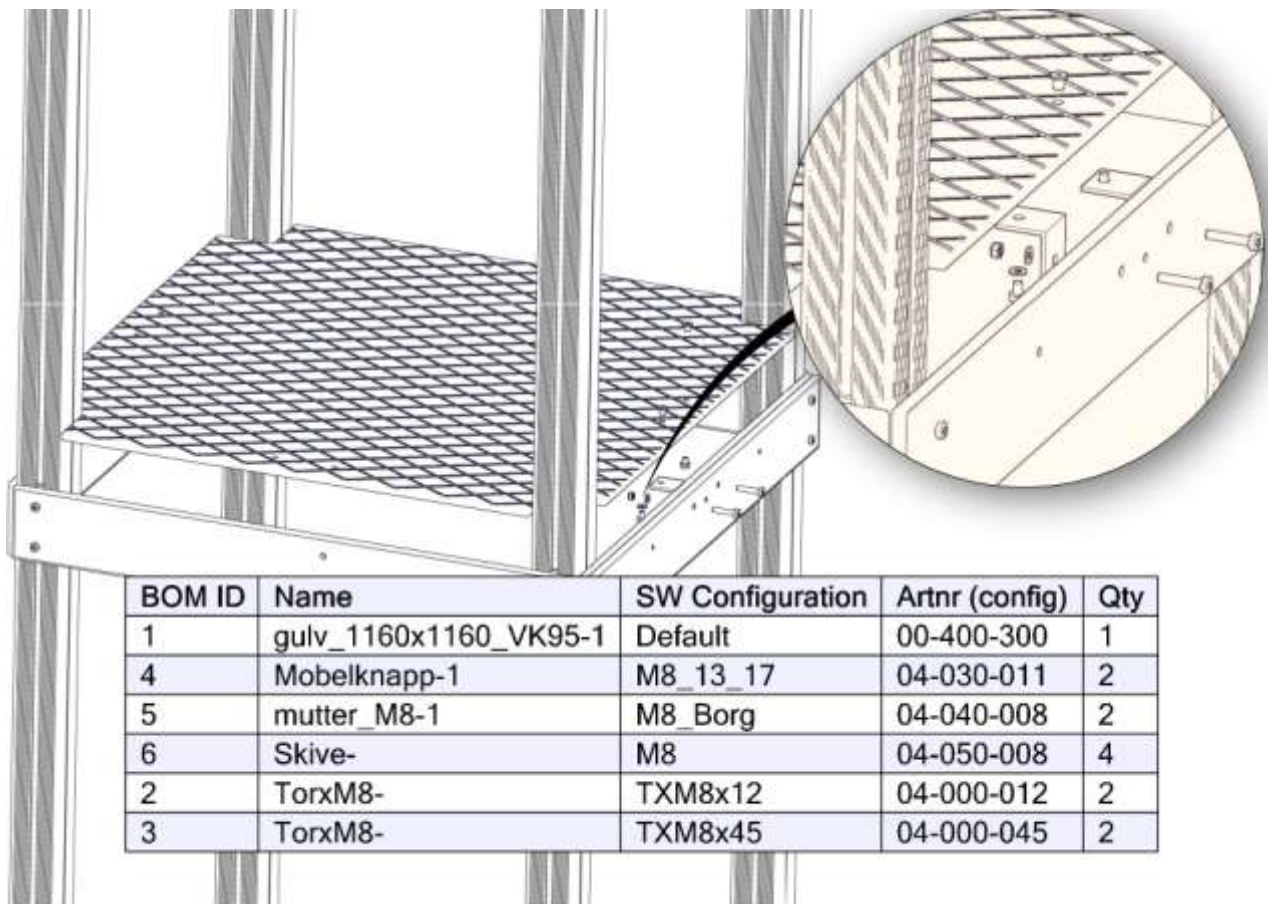
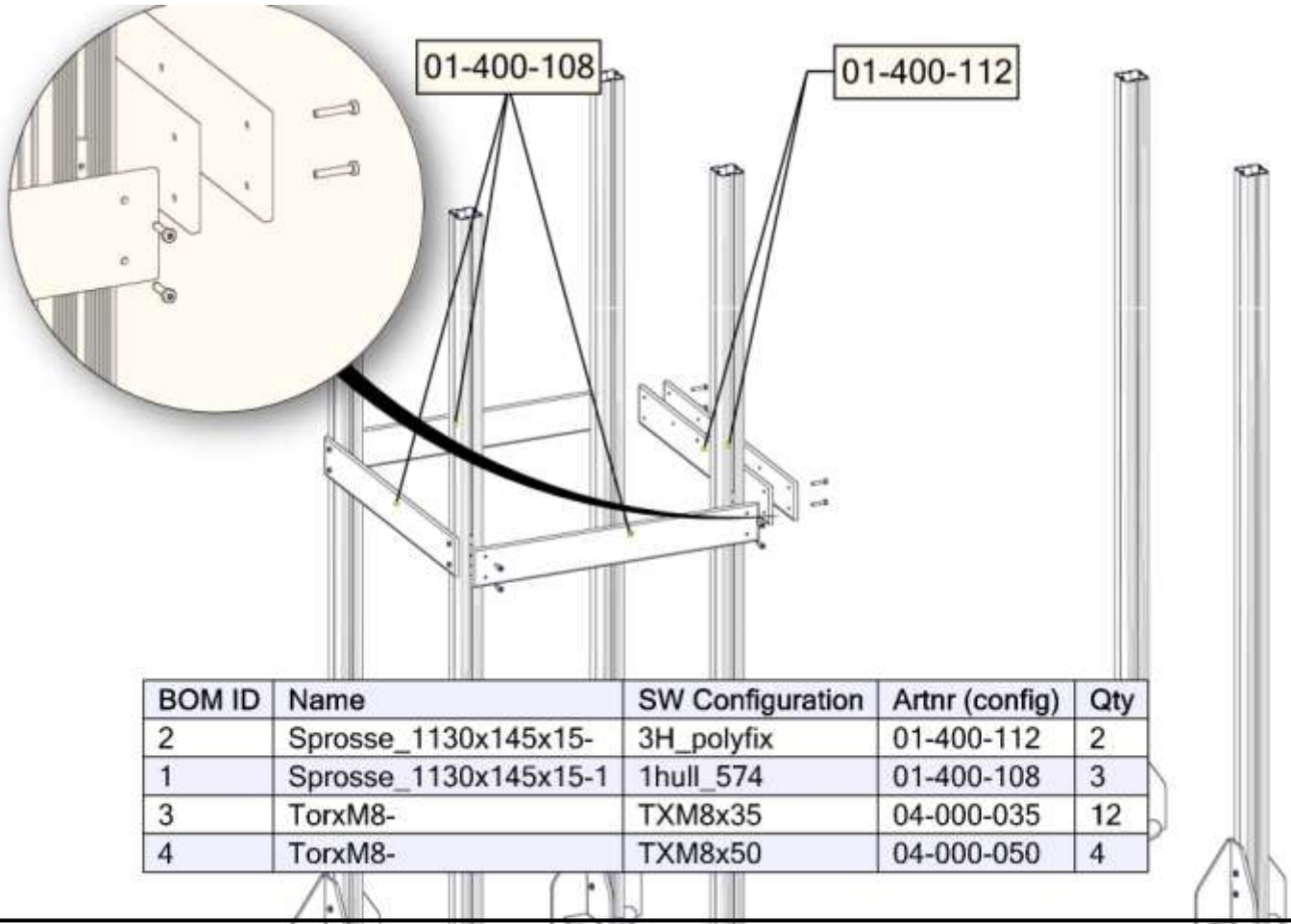

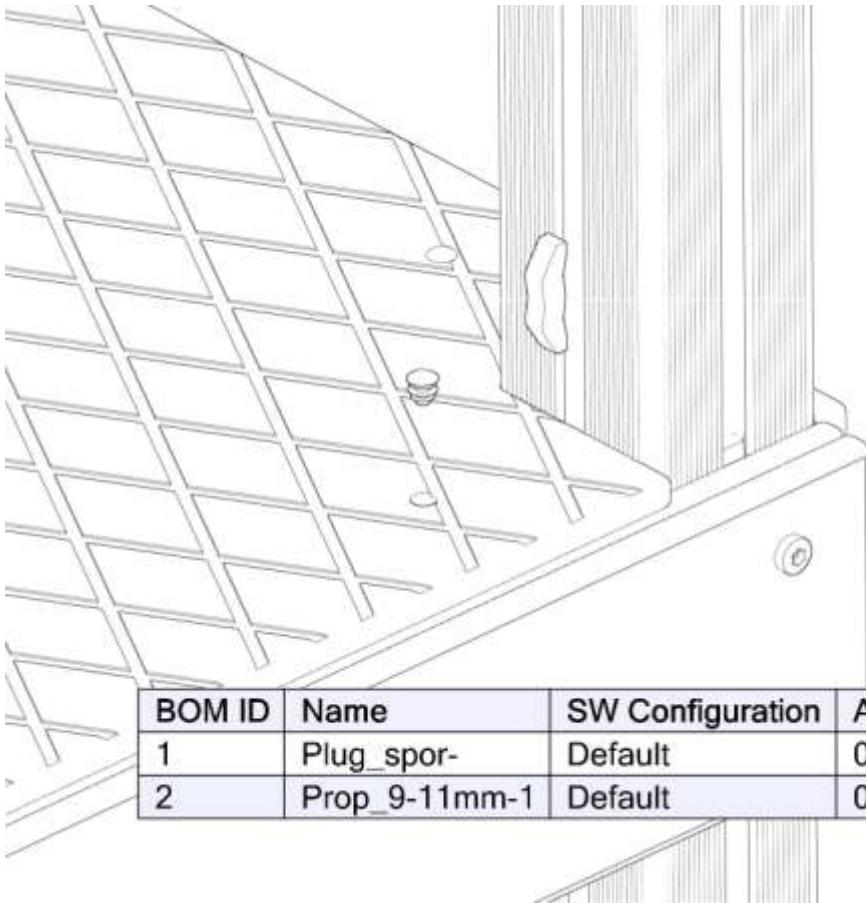

BOM ID	Name	SW Configuration	Artnr (config)	Qty
1	Plug_spor-	Default	00-400-980	8
2	Prop_9-11mm-1	Default	04-090-002	13

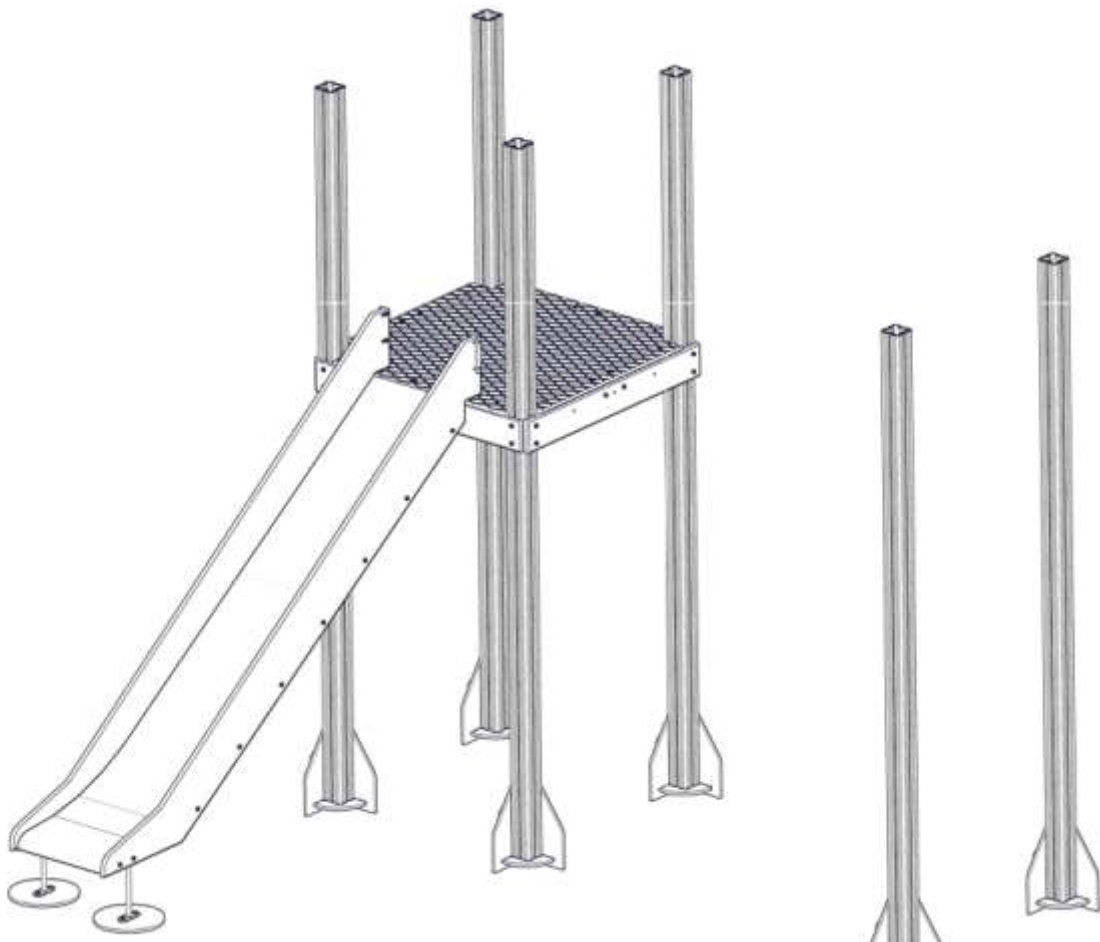

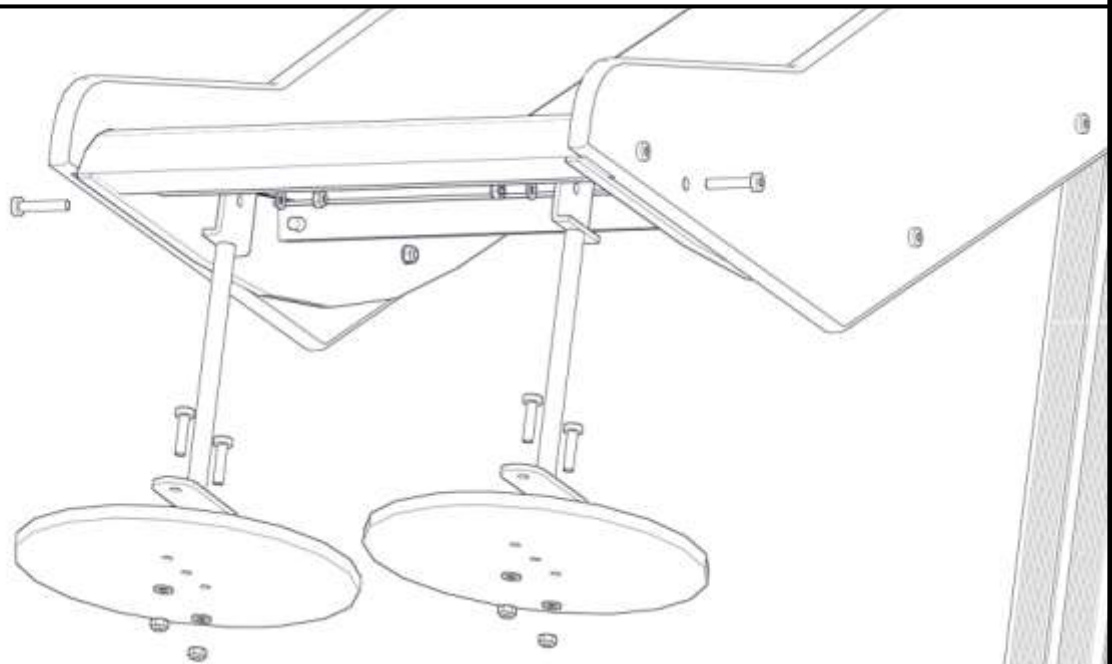

BOM ID	Name	SW Configuration	Artnr (config)	Qty
1	Fundament platte 2H-1	Hoh80	00-003-106	2
5	mutter_M8-	M8_Borg	04-040-008	6
6	Skive-	M8	04-050-008	6
2	Stalforankring-1	liten	00-100-312	2
3	TorxM8-	TXM8x35	04-000-035	4
4	TorxM8-1	TXM8x45	04-000-045	2

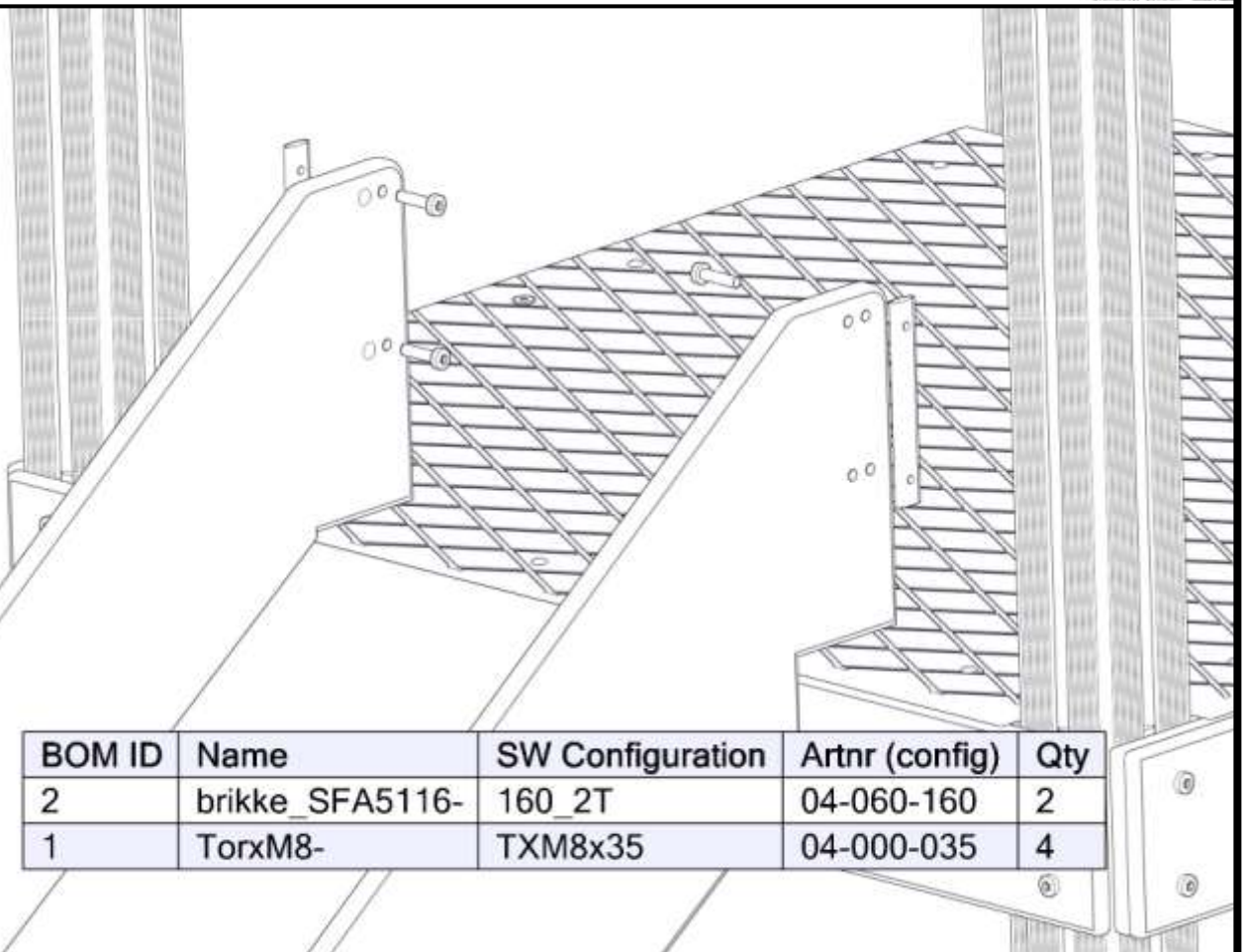

BOM ID	Name	SW Configuration	Artnr (config)	Qty
2	brikke_SFA5116-	160_2T	04-060-160	2
1	TorxM8-	TXM8x35	04-000-035	4

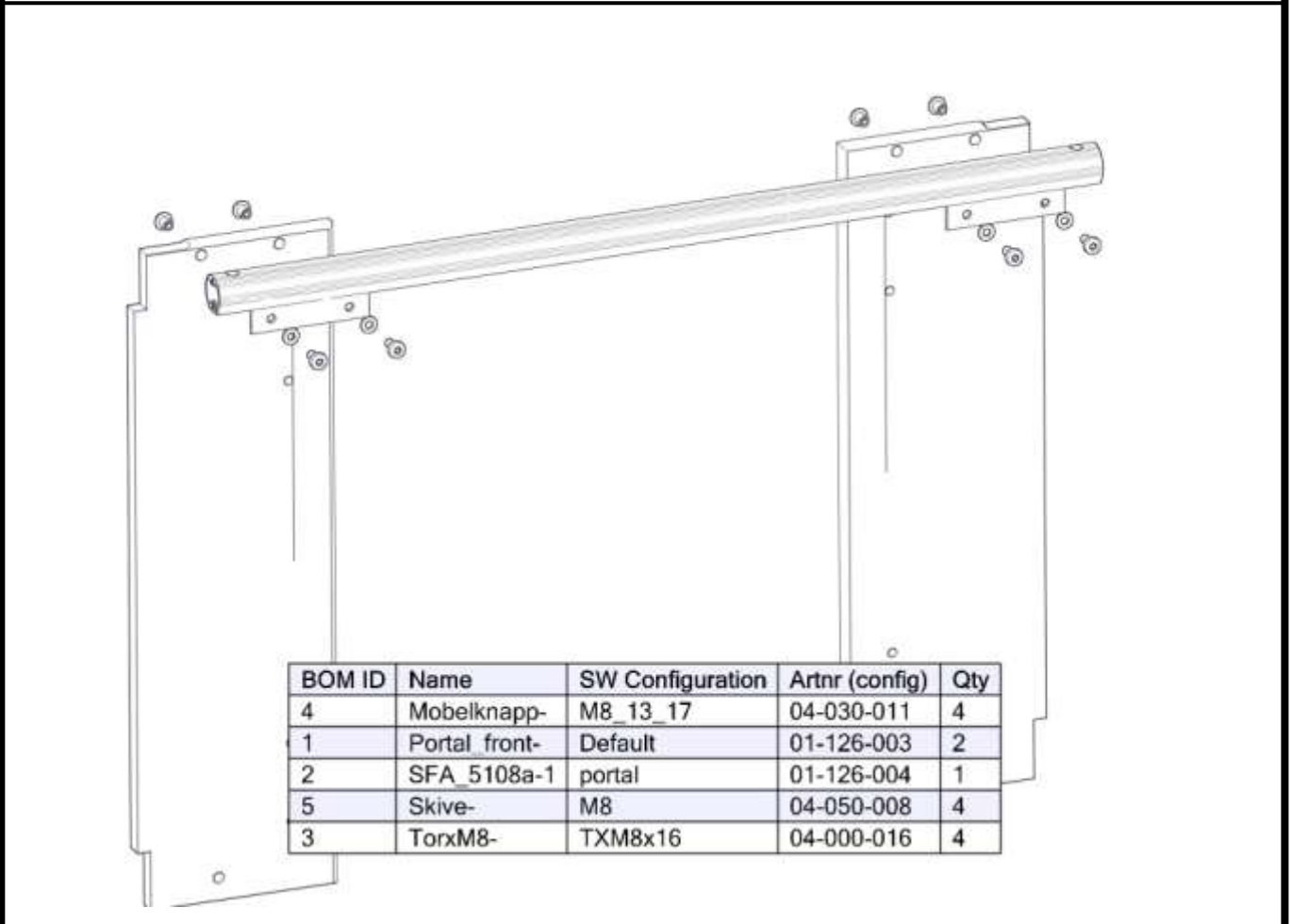
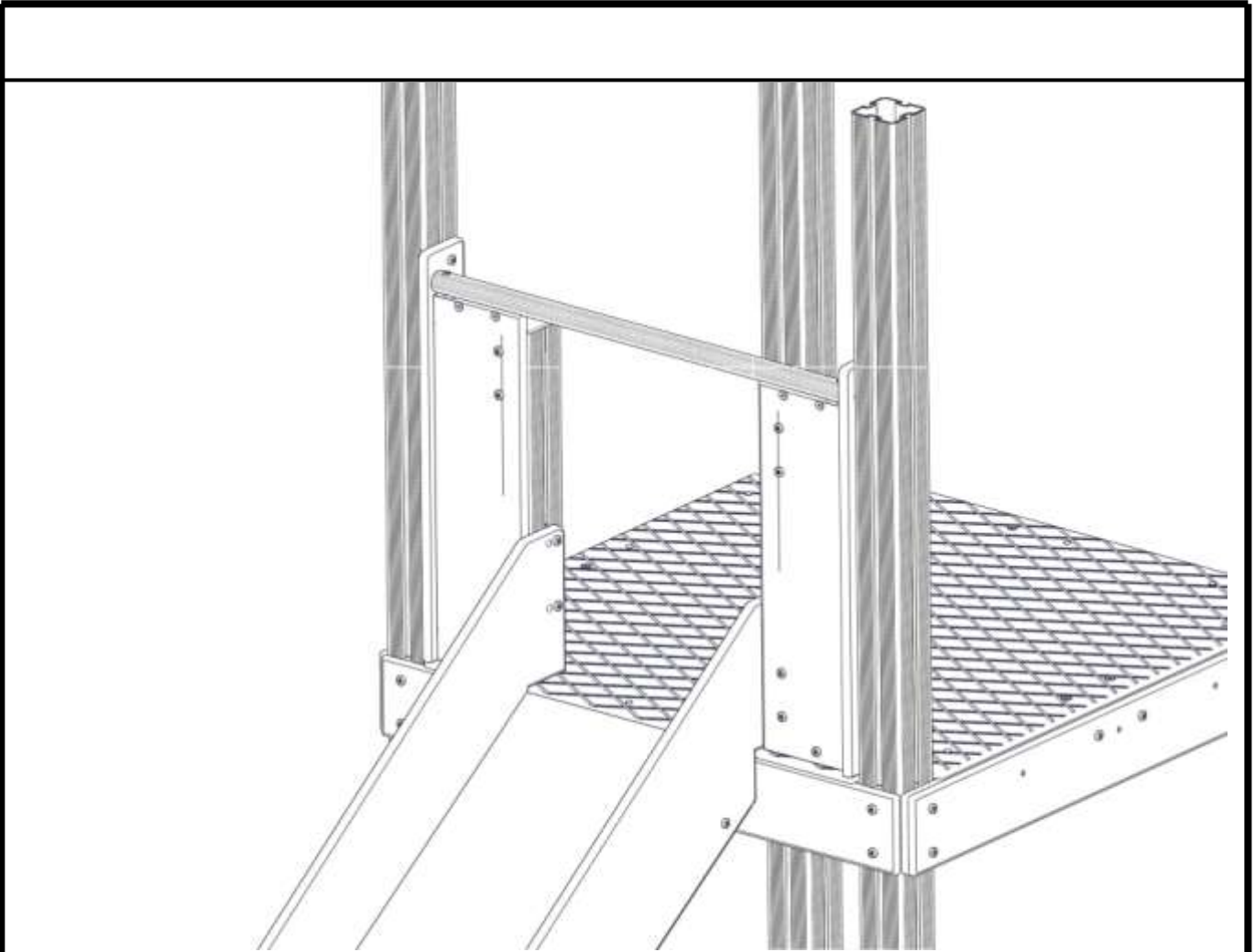

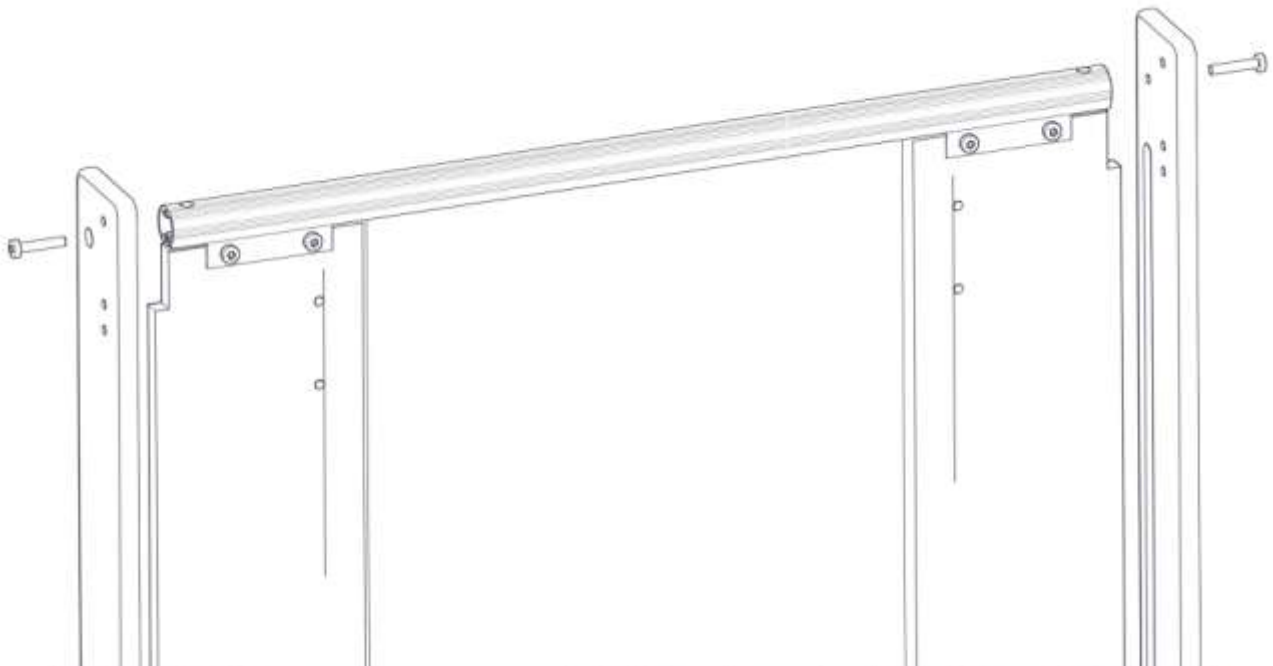

BOM ID	Name	SW Configuration	Artnr (config)	Qty
2	porttal_side-1	Default	01-126-002	1
1	porttal_side_mirror-1	Default	01-126-001	1
3	TorxM8-	TXM8x45	04-000-045	2

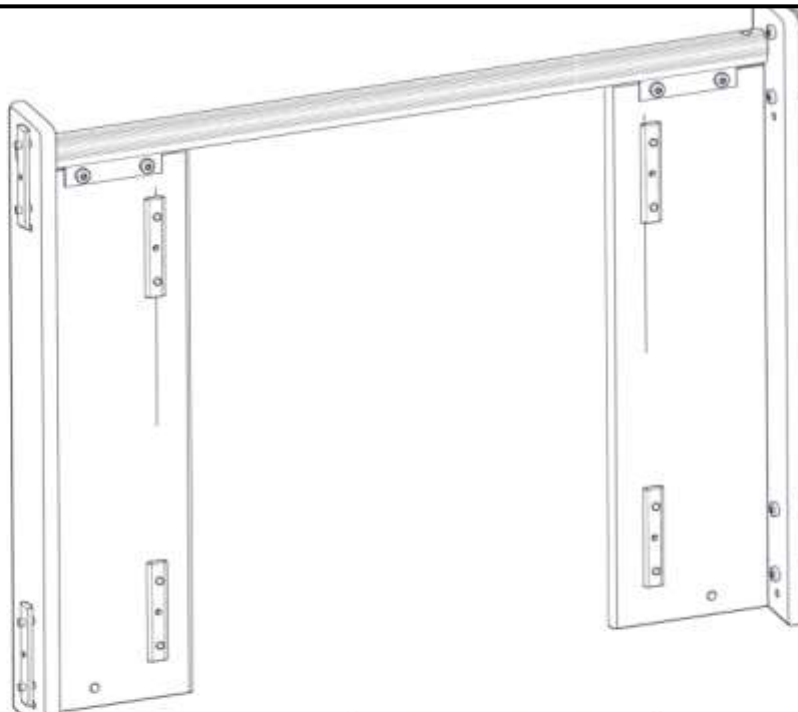

BOM ID	Name	SW Configuration	Artnr (config)	Qty
2	brikke_SFA5116-1	120_3T	04-060-120	8
1	TorxM8-	TXM8x35	04-000-035	16

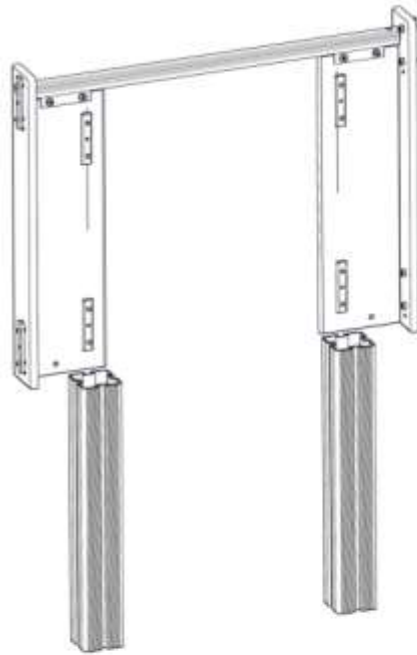

BOM ID	Name	SW Configuration	Artnr (config)	Qty
1	VK95_SFA5117_A-	Portal	00-400-009	2

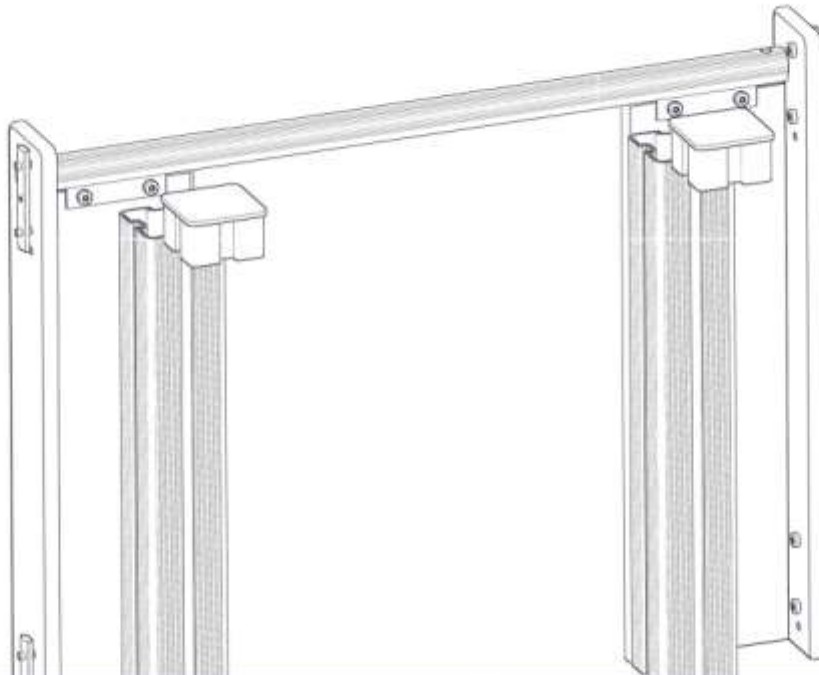

BOM ID	Name	SW Configuration	Artnr (config)	Qty
1	StolpEndeVK95Stolpe-	Default	00-400-998	2

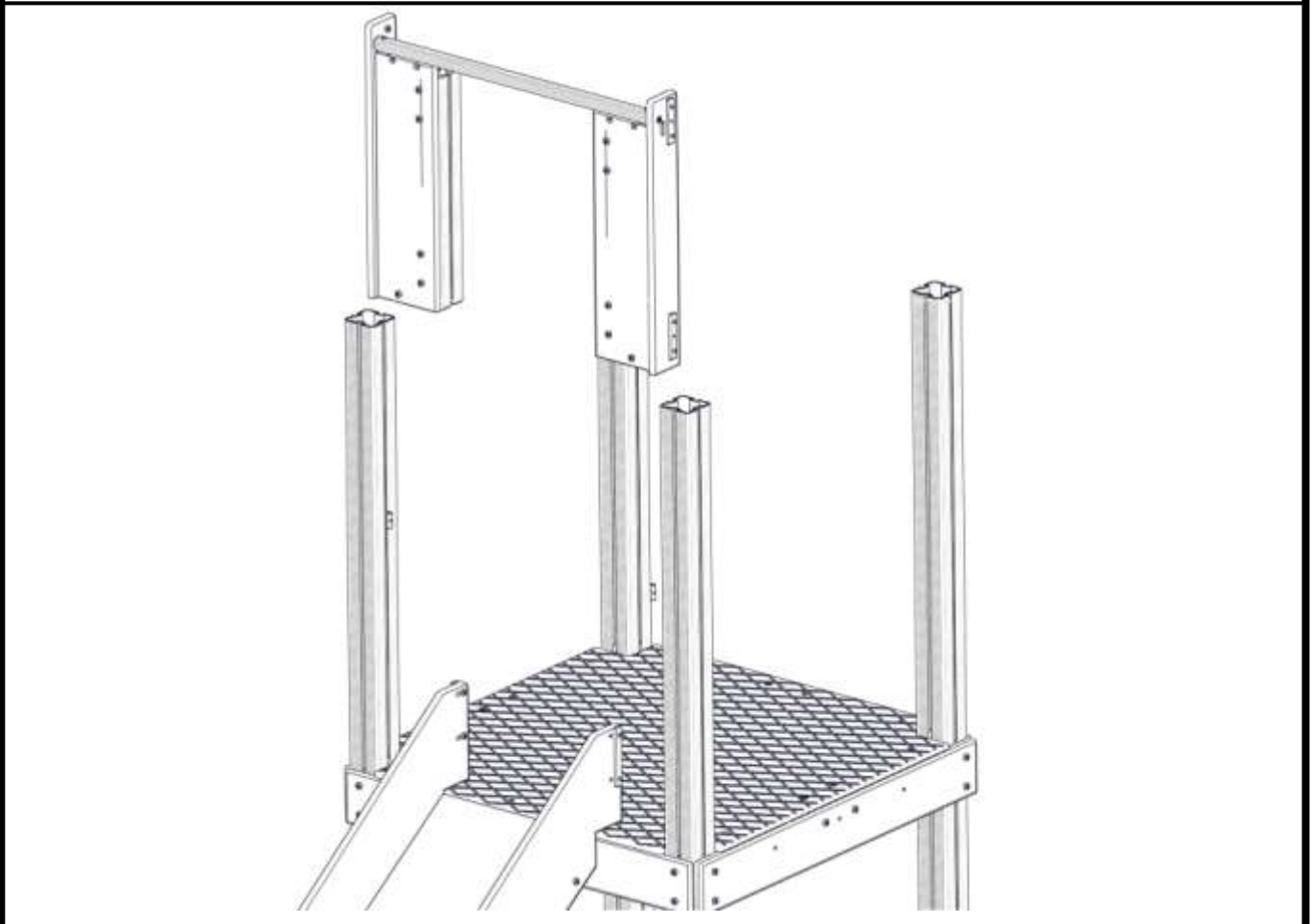
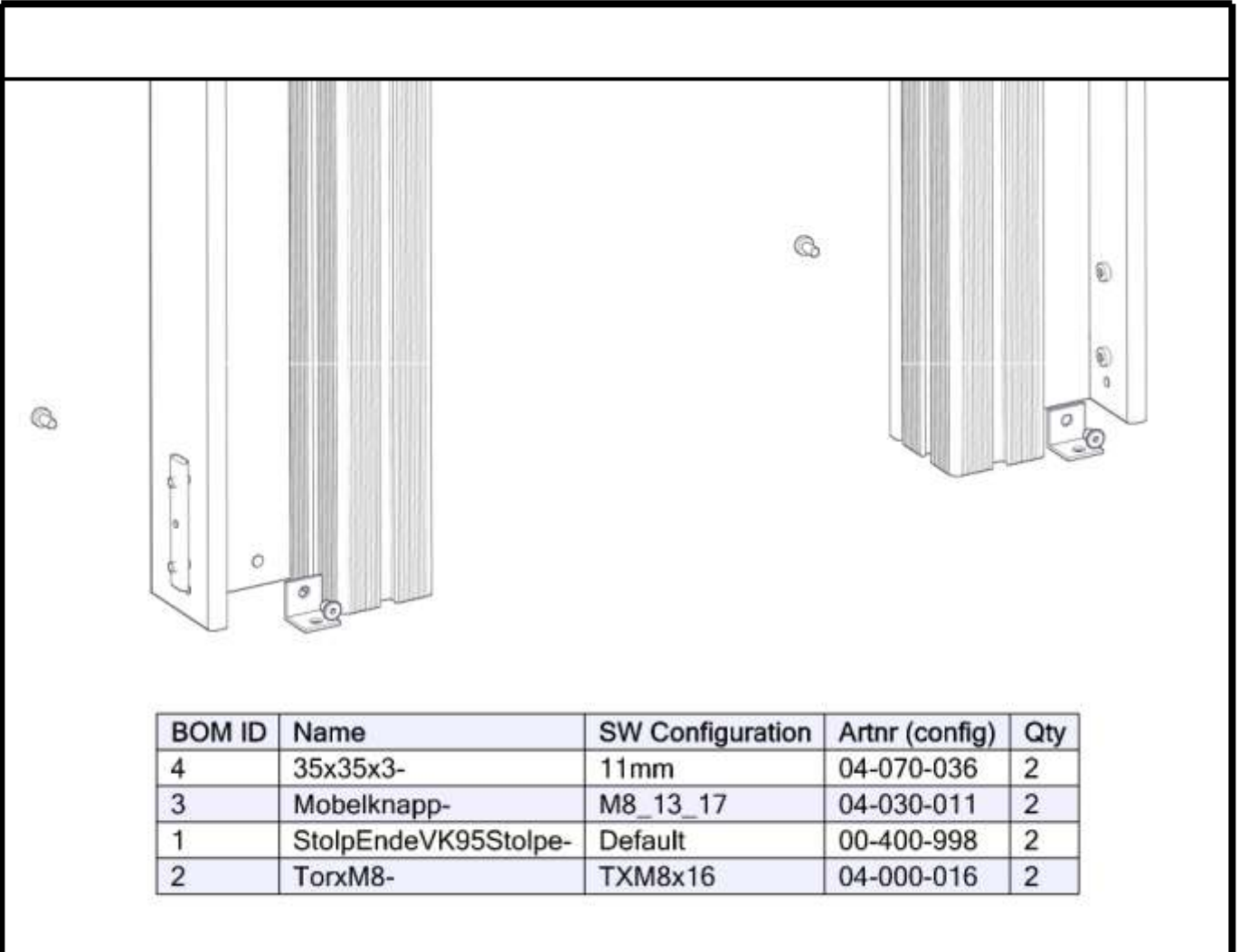

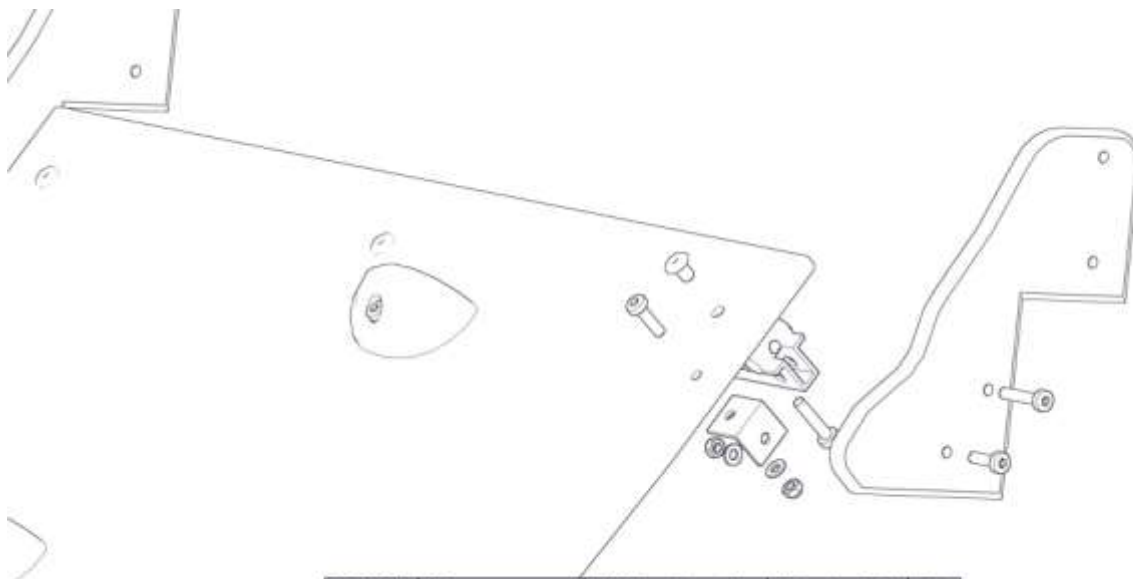
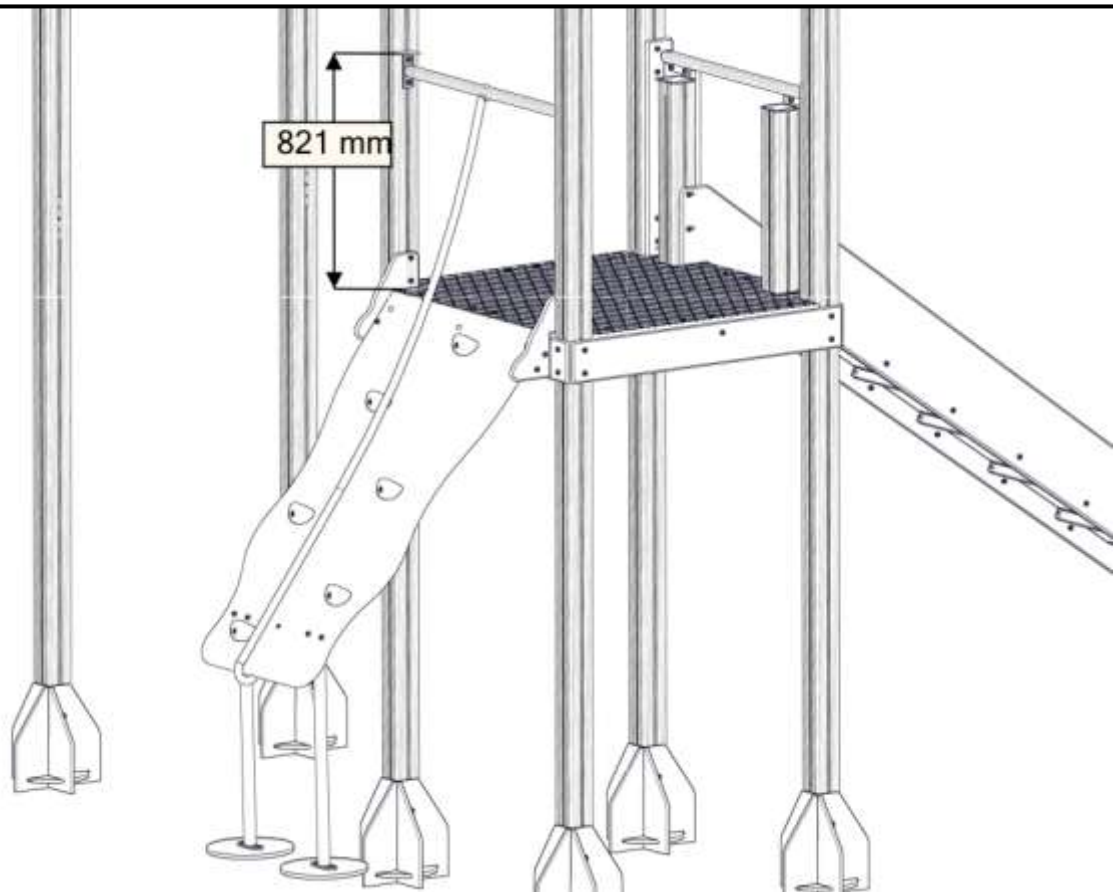

BOM ID	Name	SW Configuration	Artnr (config)	Qty
10	35x35x3-1	9mm	04-070-035	1
1	FesteOpptrekk-	Default	01-129-113	2
7	Mobelknapp_R-	M8_16	04-030-016	3
8	mutter M8-	M8_Borg	04-040-008	2
2	SFA 5105a-1	910_opptrekk	02-500-086	1
9	Skive-	M8	04-050-008	2
3	Torxm8-	TXM8x30	04-000-030	2
4	Torxm8-	TXM8x40	04-000-040	3
5	Torxm8-	TXM8x45	04-000-045	2

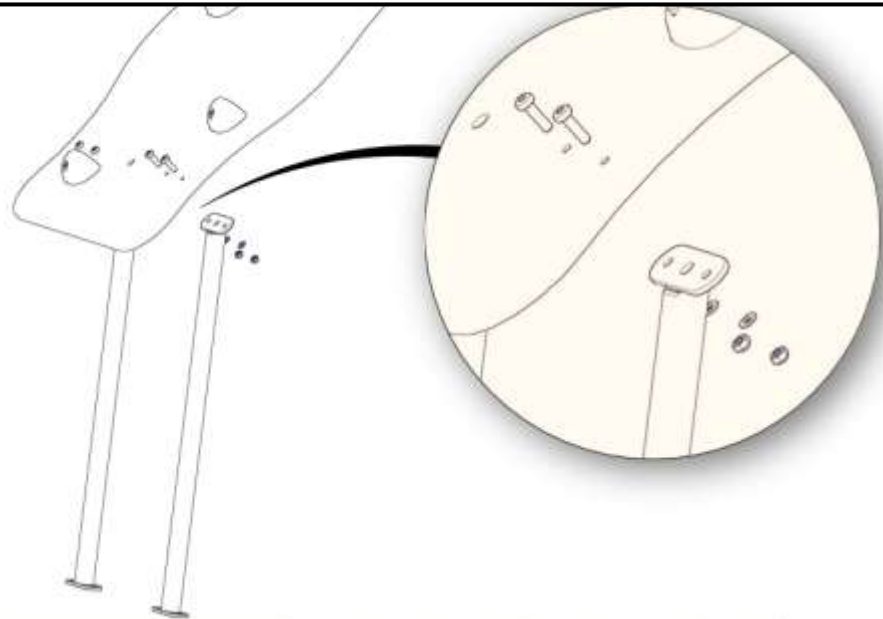

BOM ID	Name	SW Configuration	Artnr (config)	Qty
1	forankringOpptreksplate-2	Default	01-129-114	1
3	mutter_M8-1	M8_Borg	04-040-008	4
4	Skive-1	M8	04-050-008	4
2	TorxM8-1	TXM8x30	04-000-030	4

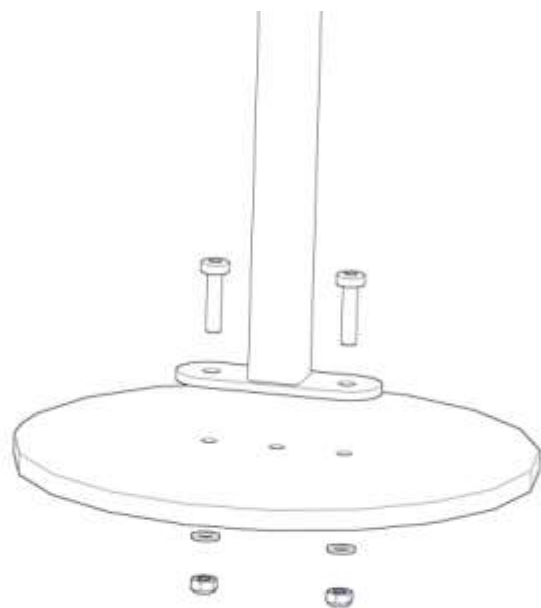
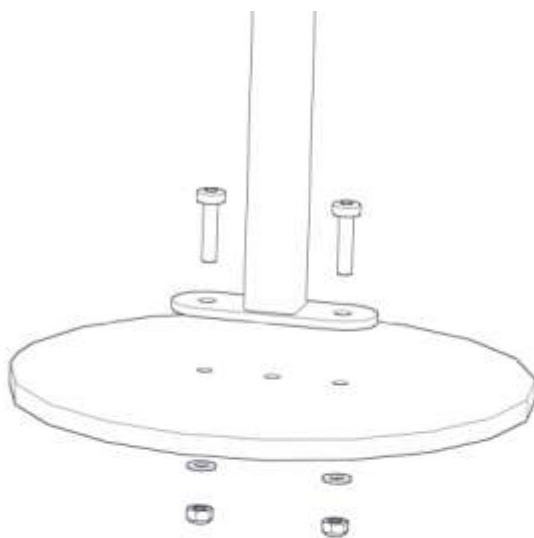

BOM ID	Name	SW Configuration	Artnr (config)	Qty
1	Fundament_platte_2H-	Hoh80	00-003-106	2
3	mutter_M8-	M8_Borg	04-040-008	4
4	Skive-	M8	04-050-008	4
2	TorxM8-	TXM8x35	04-000-035	4

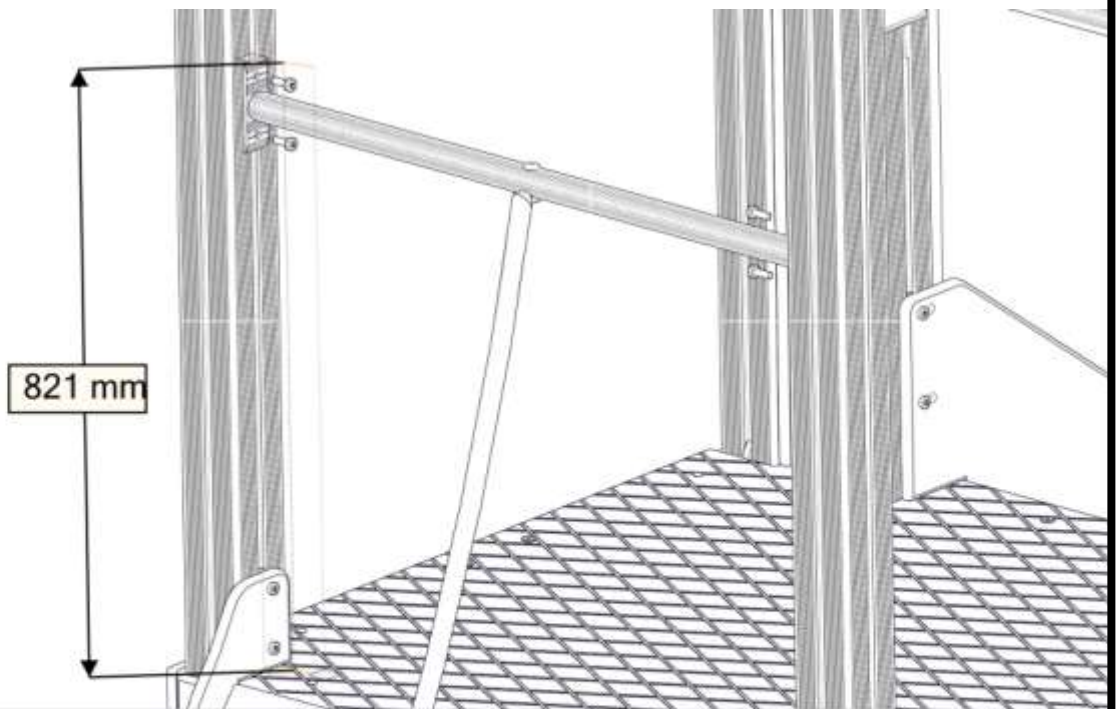
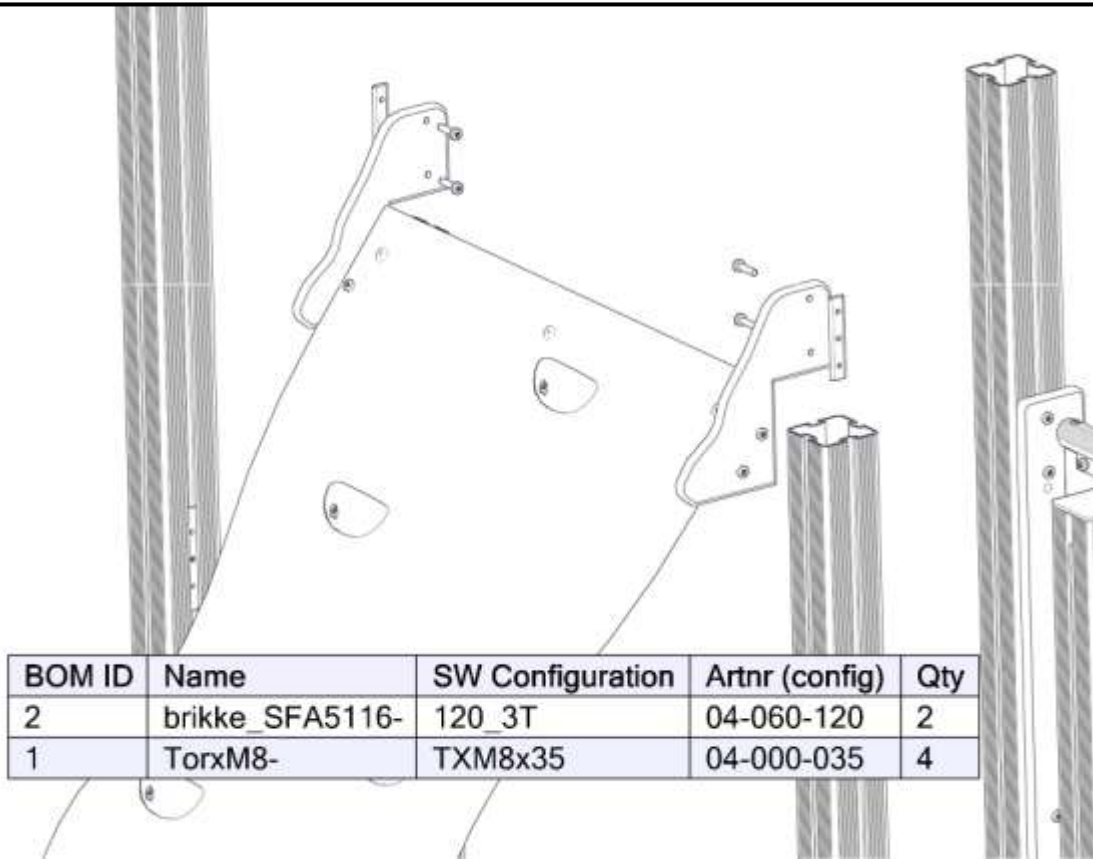

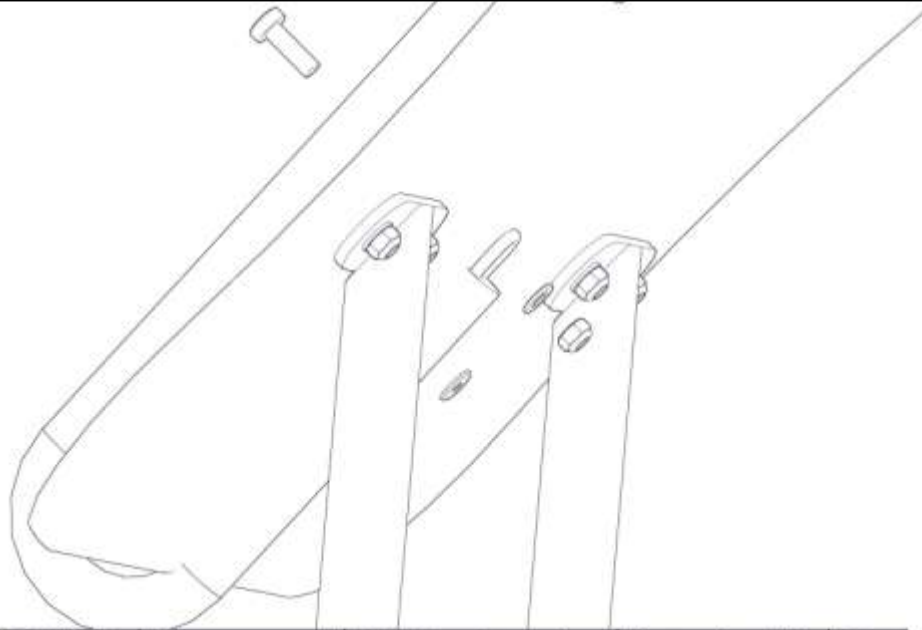

BOM ID	Name	SW Configuration	Artnr (config)	Qty
2	mutter_M8-4	M8_Borg	04-040-008	1
3	Skive-4	M8	04-050-008	1
1	TorxM8-8	TXM8x25	04-000-025	1

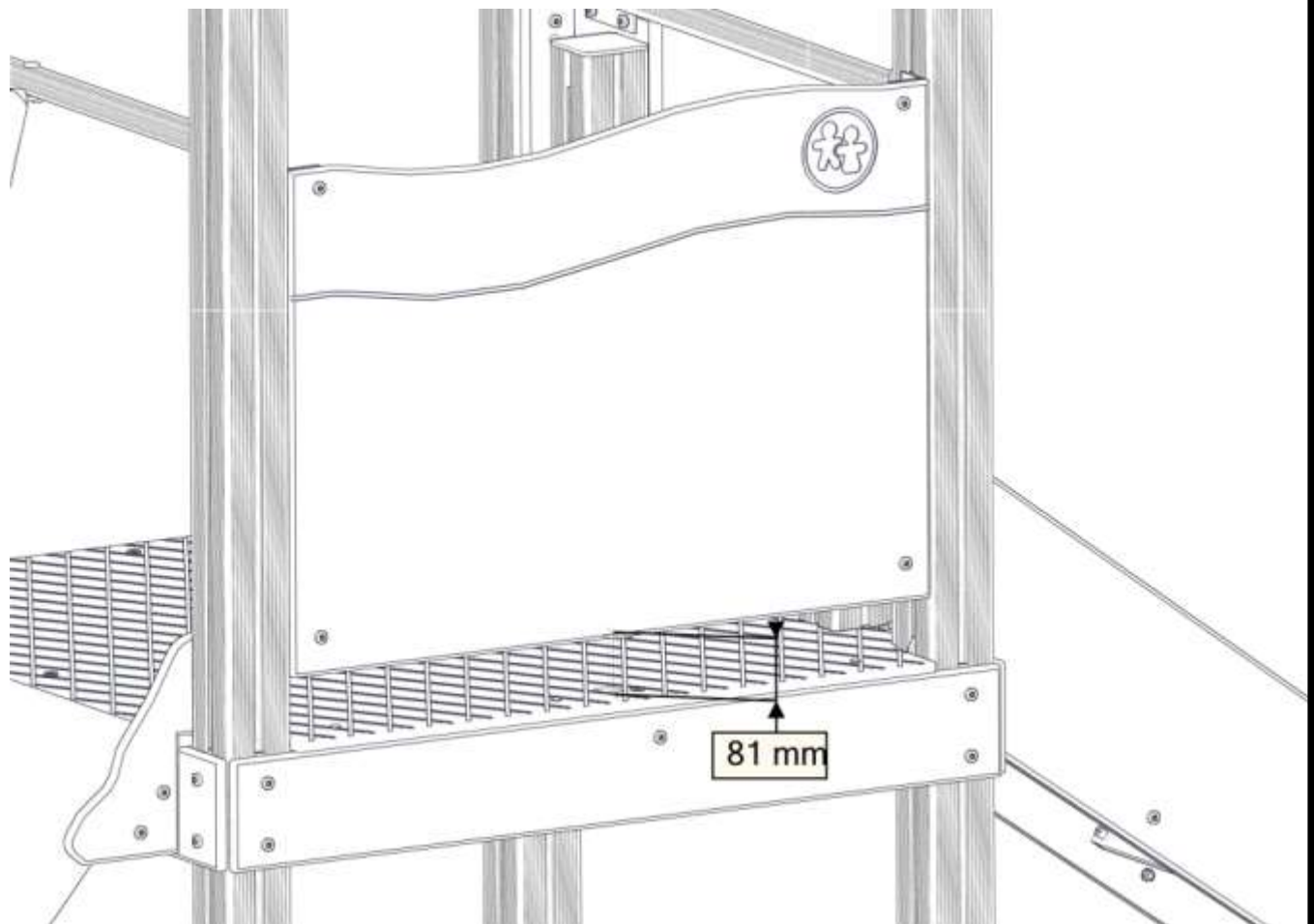

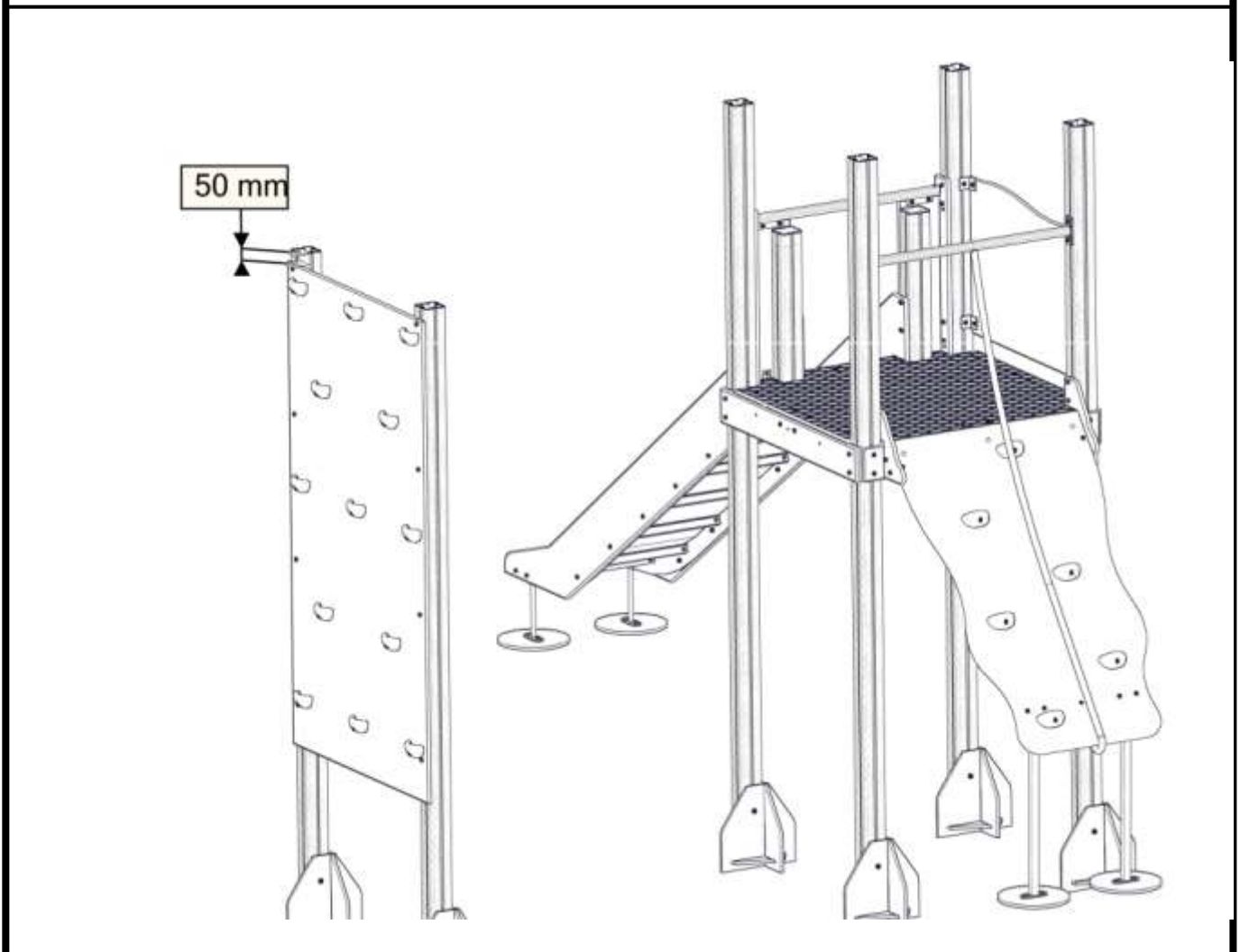
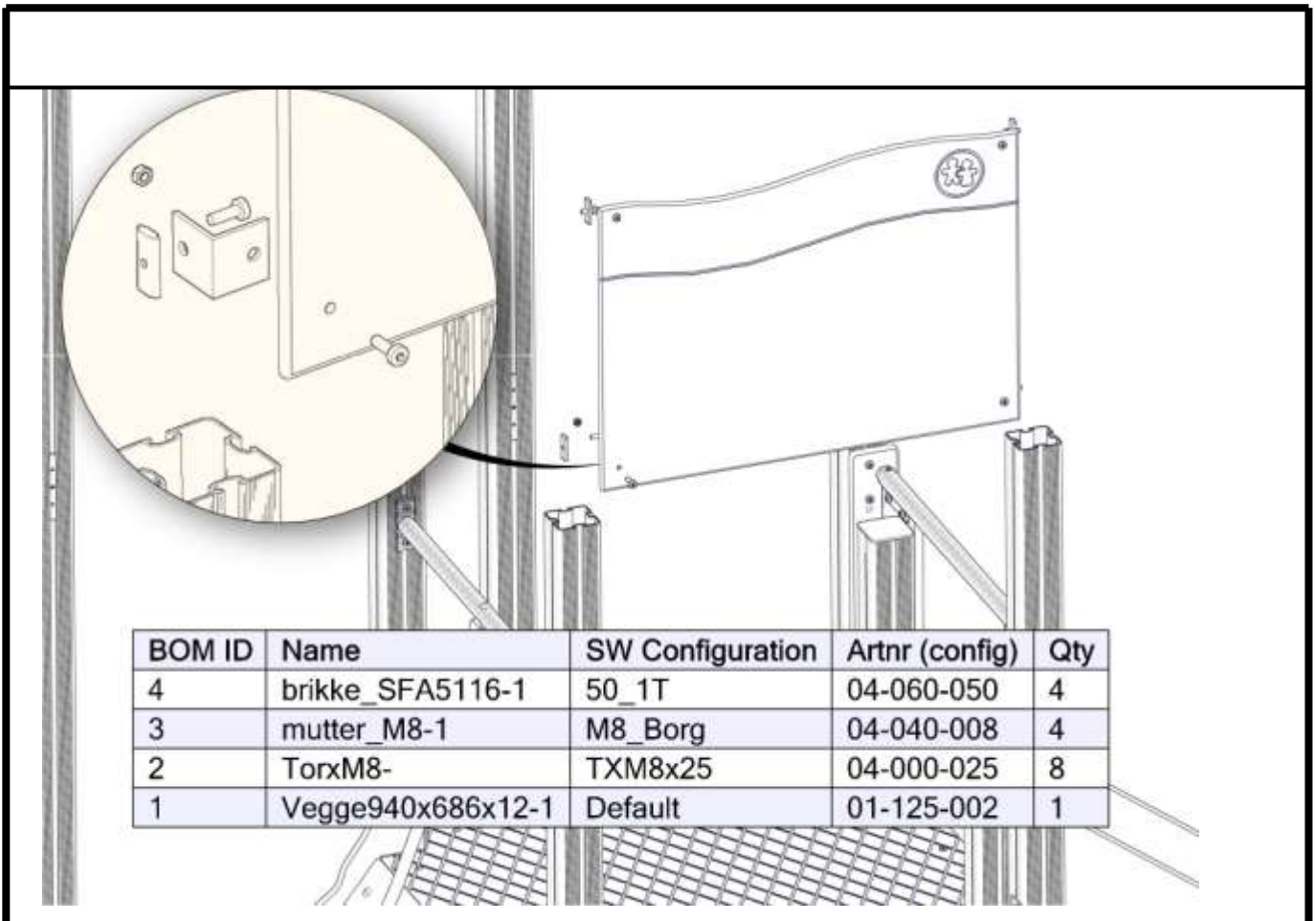

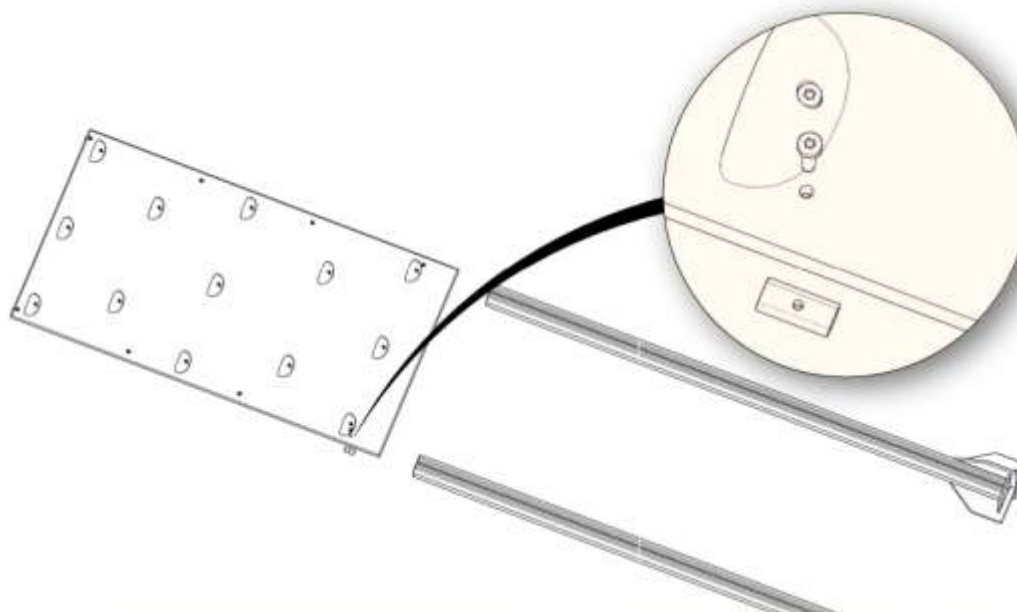

BOM ID	Name	SW Configuration	Artnr (config)	Qty
2	brikke_SFA5116-1	50_1T	04-060-050	8
3	Klatrevegge_2075x1130-1	Default	00-400-720	1
1	TorxM8-1	TXM8x35	04-000-035	8

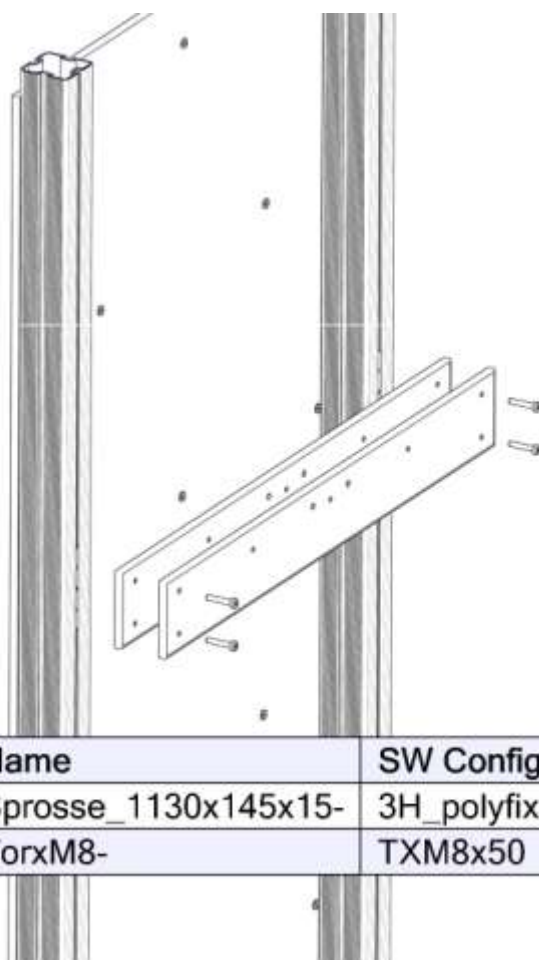

BOM ID	Name	SW Configuration	Artnr (config)	Qty
1	Sprosse_1130x145x15-	3H_polyfix	01-400-112	2
2	TorxM8-	TXM8x50	04-000-050	4

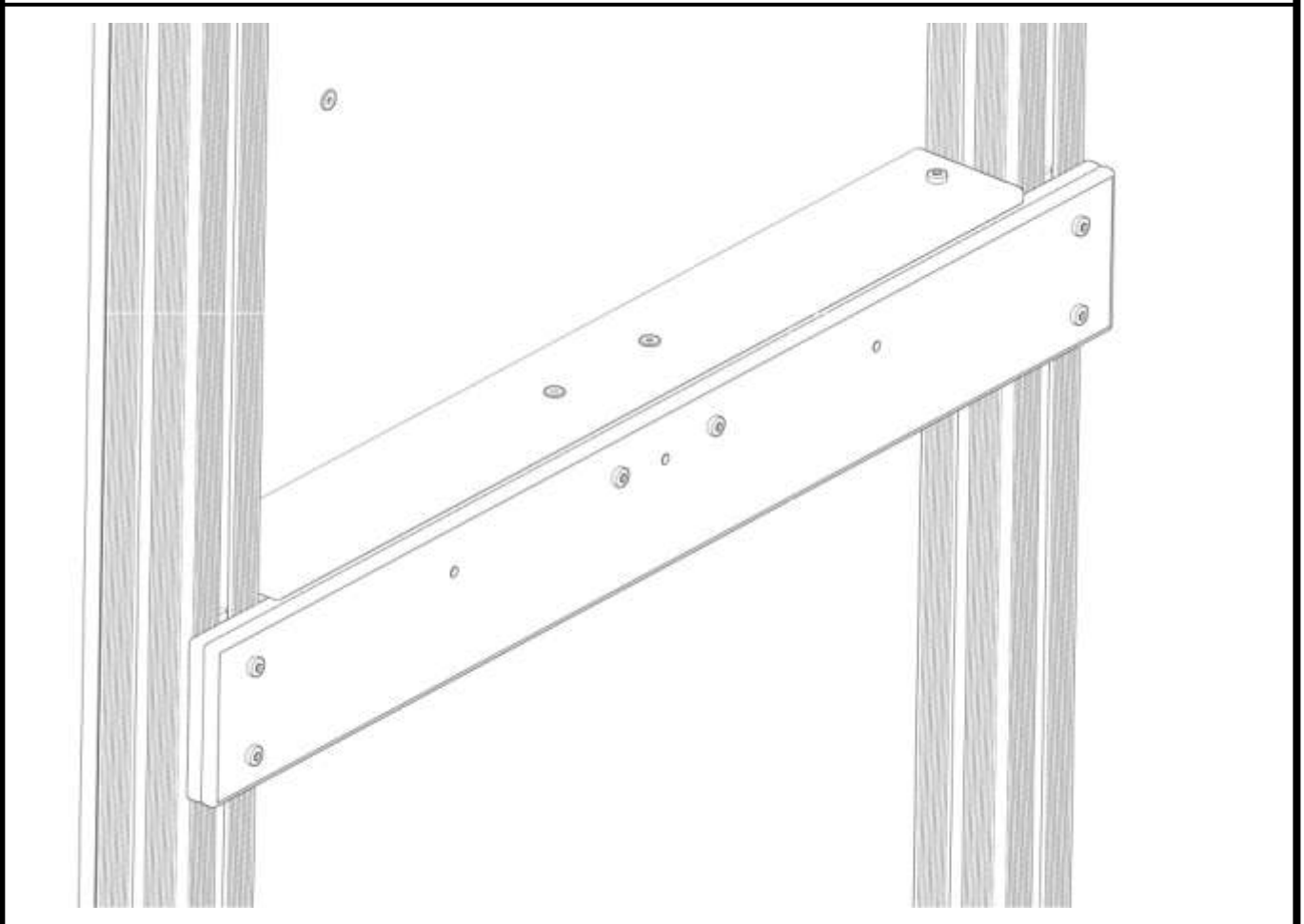
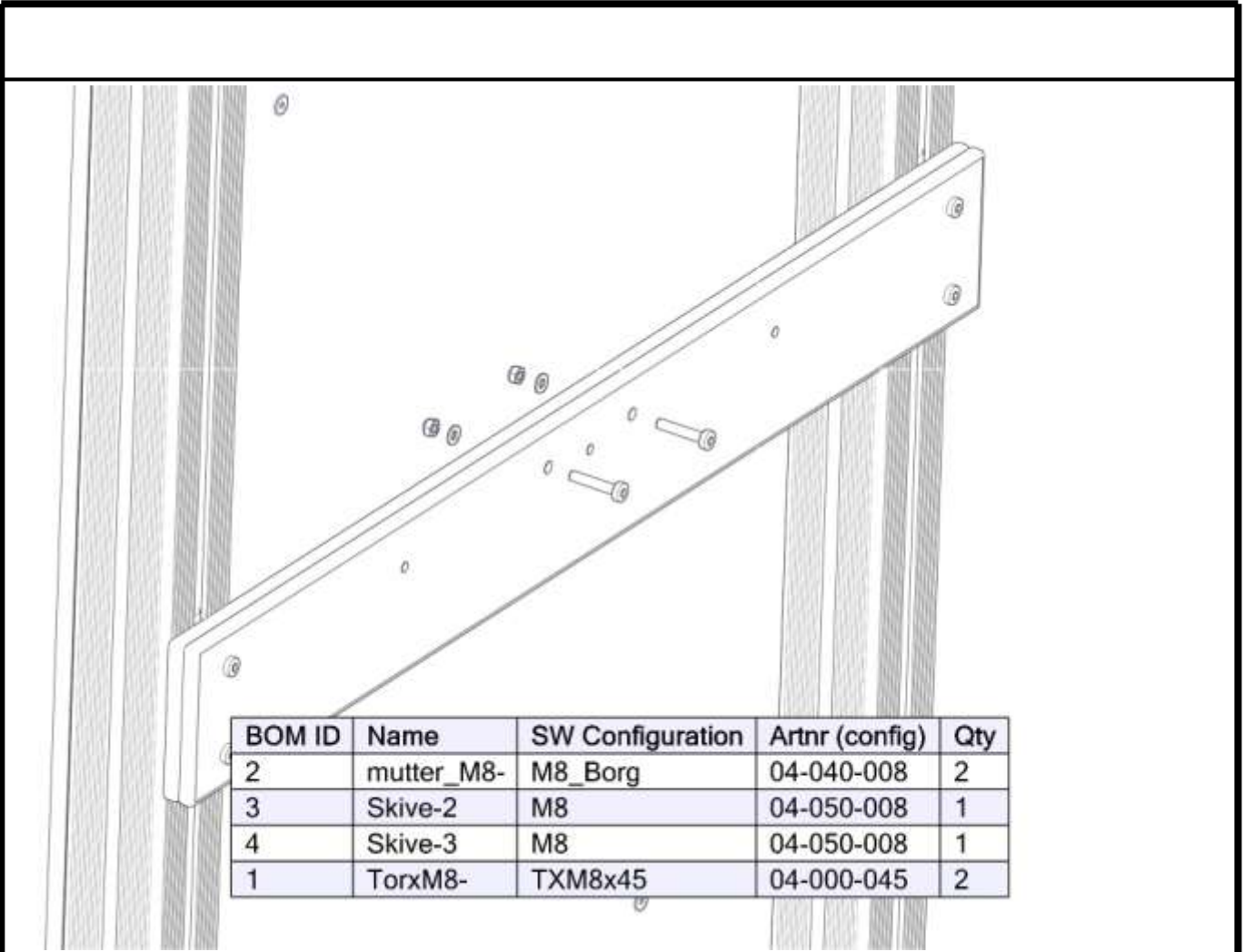

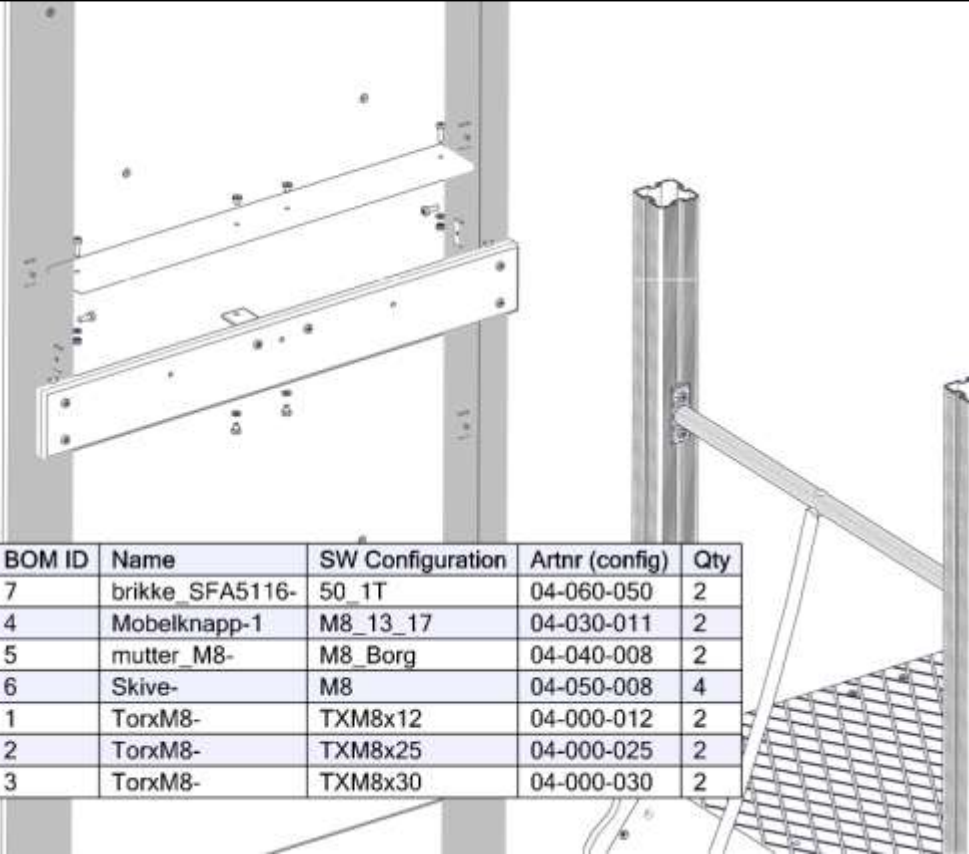

BOM ID	Name	SW Configuration	Artnr (config)	Qty
7	brikke_SFA5116-	50_1T	04-060-050	2
4	Mobelknapp-1	M8_13_17	04-030-011	2
5	mutter_M8-	M8_Borg	04-040-008	2
6	Skive-	M8	04-050-008	4
1	TorxM8-	TXM8x12	04-000-012	2
2	TorxM8-	TXM8x25	04-000-025	2
3	TorxM8-	TXM8x30	04-000-030	2

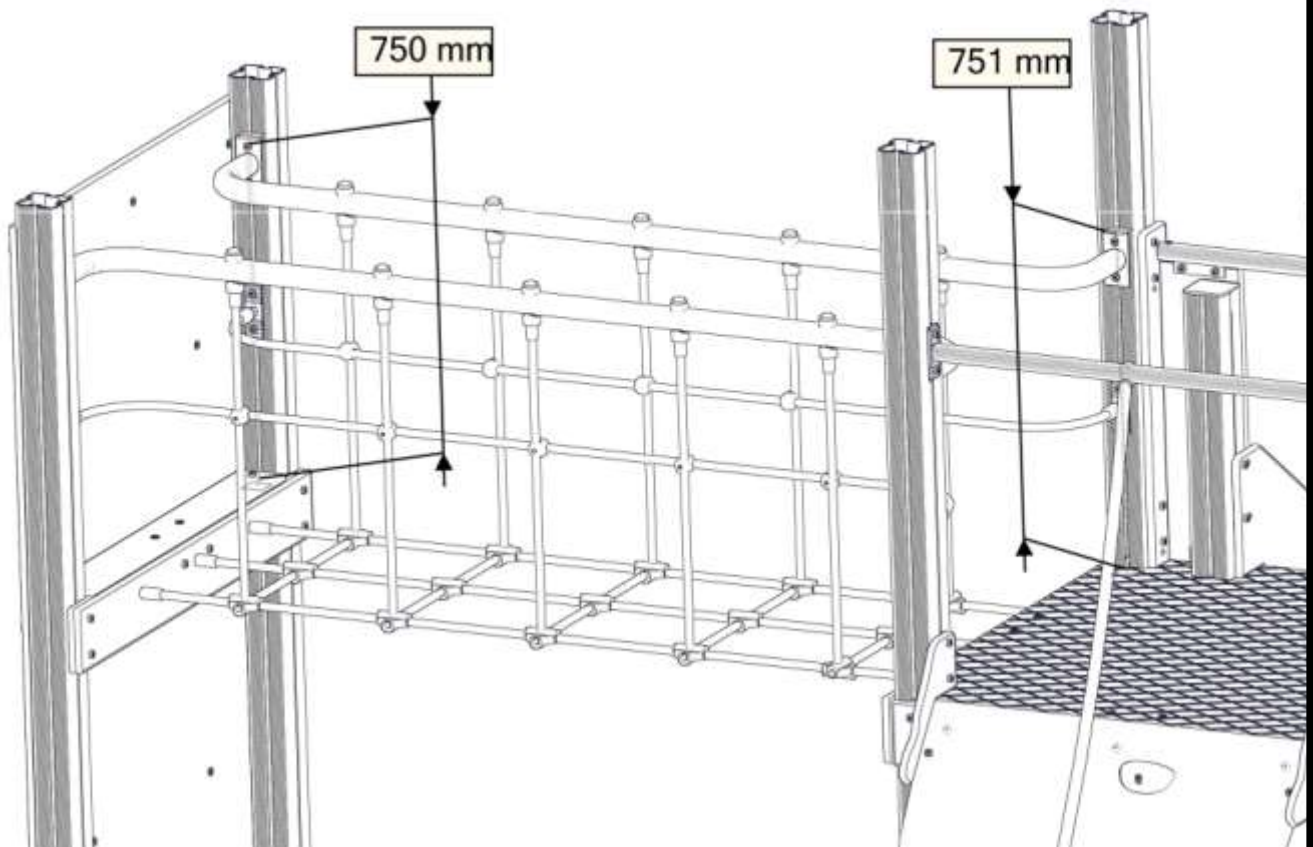

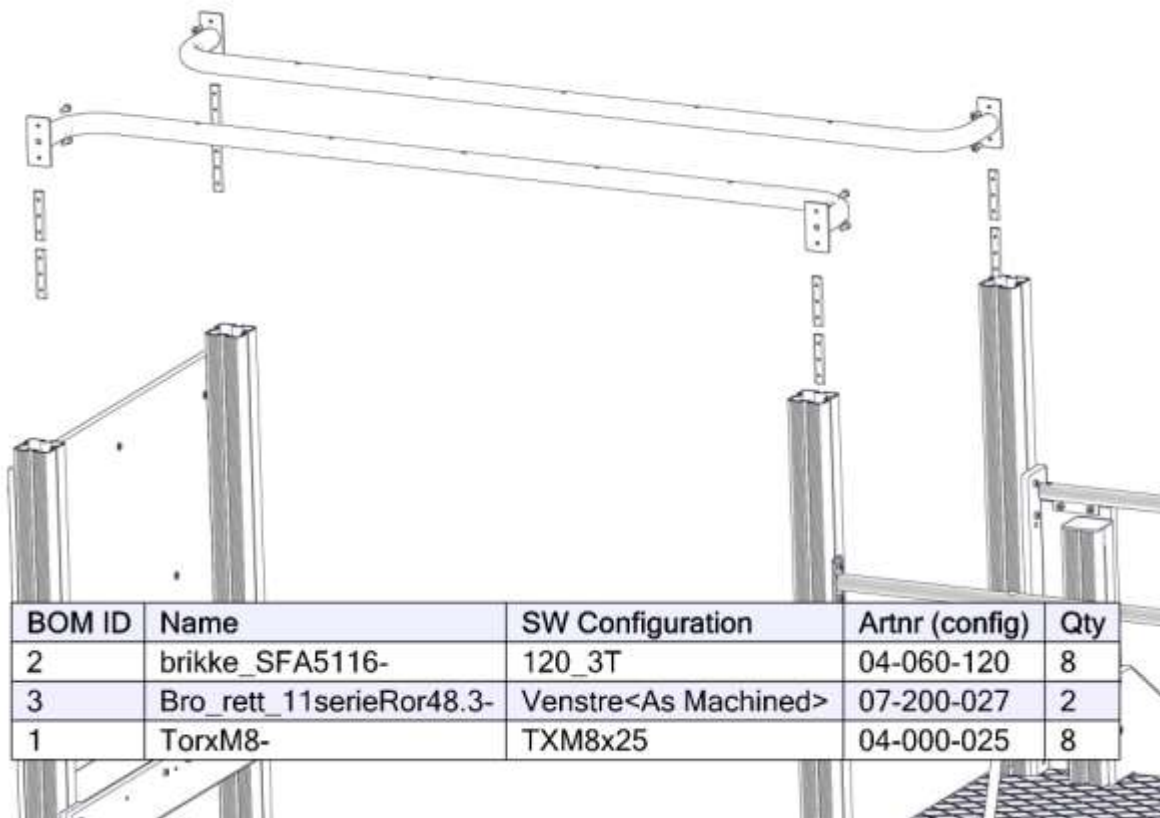

BOM ID	Name	SW Configuration	Artnr (config)	Qty
2	brikke_SFA5116-	120_3T	04-060-120	8
3	Bro_rett_11serieRor48.3-	Venstre<As Machined>	07-200-027	2
1	TorxM8-	TXM8x25	04-000-025	8

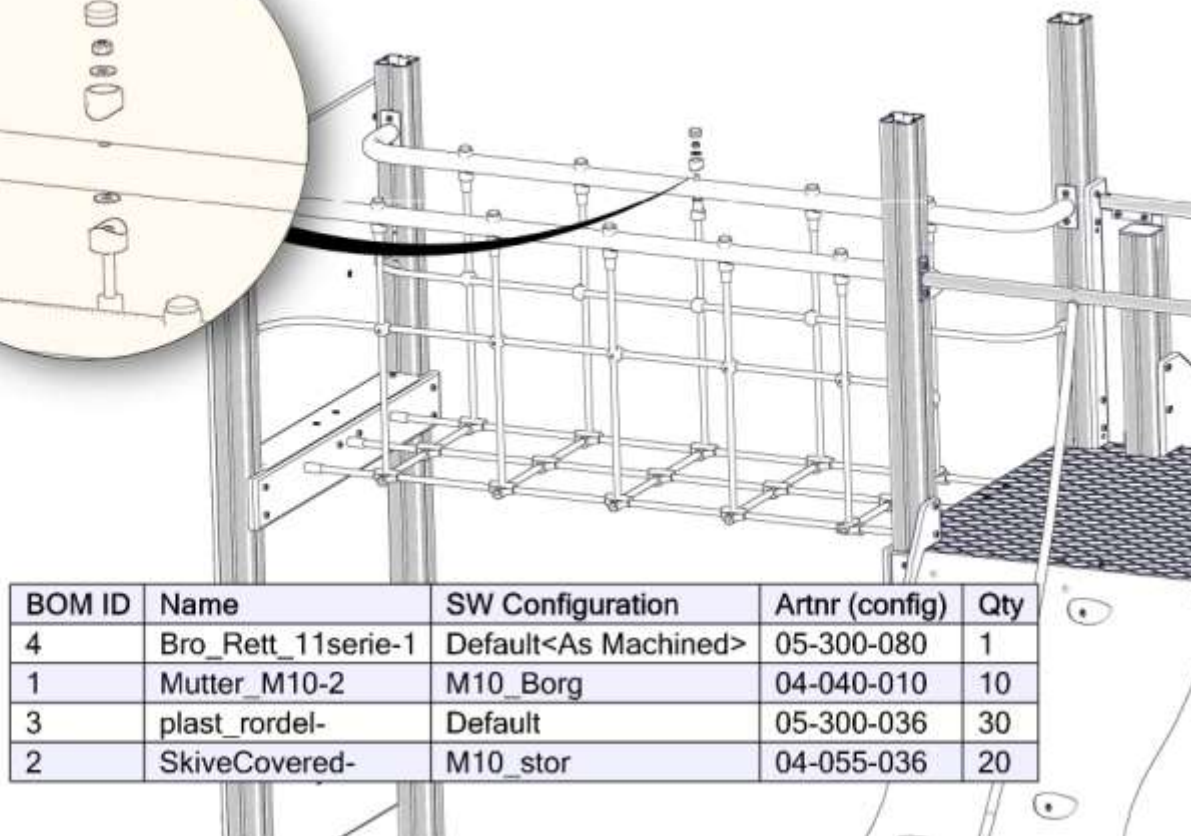
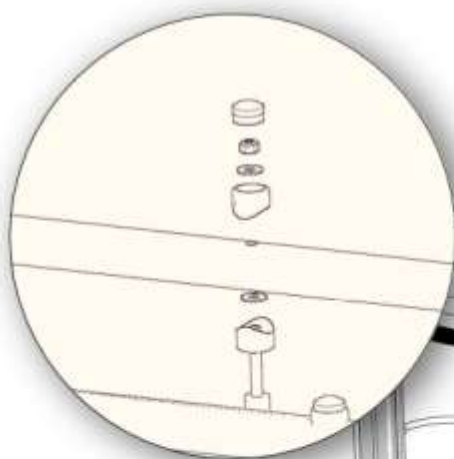

BOM ID	Name	SW Configuration	Artnr (config)	Qty
4	Bro_Rett_11serie-1	Default<As Machined>	05-300-080	1
1	Mutter_M10-2	M10_Borg	04-040-010	10
3	plast_rordel-	Default	05-300-036	30
2	SkiveCovered-	M10_stor	04-055-036	20

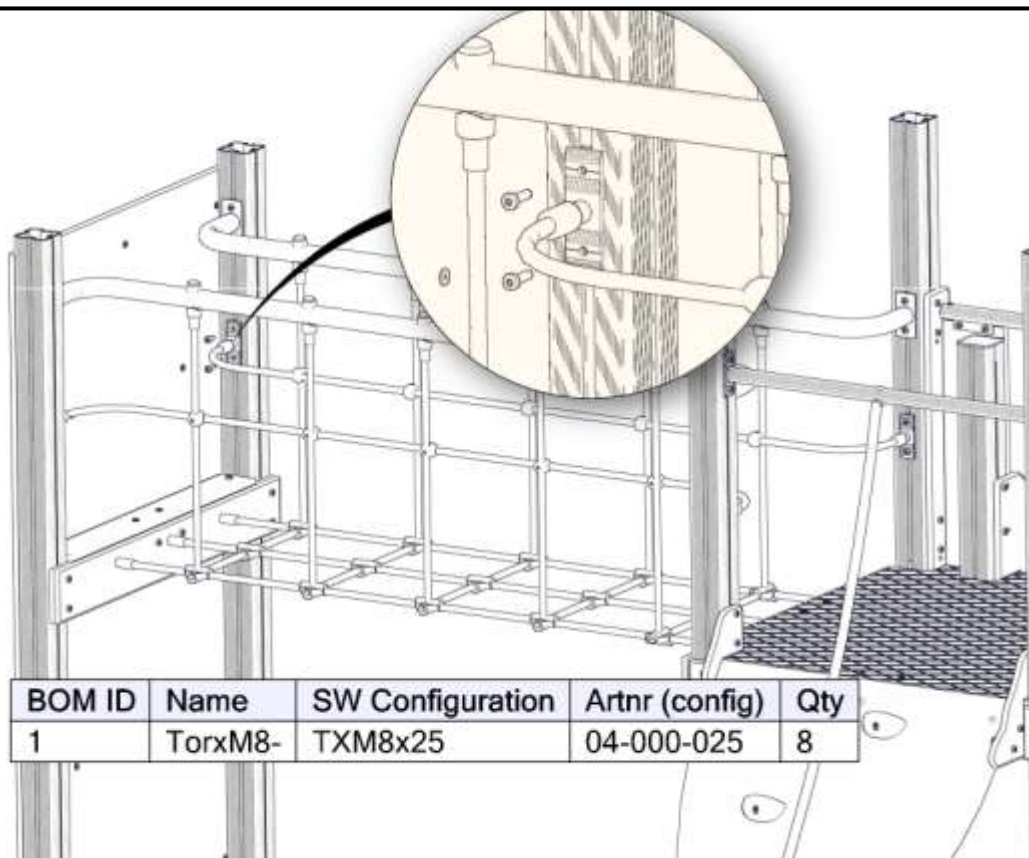

BOM ID	Name	SW Configuration	Artnr (config)	Qty
1	TorxM8-	TXM8x25	04-000-025	8

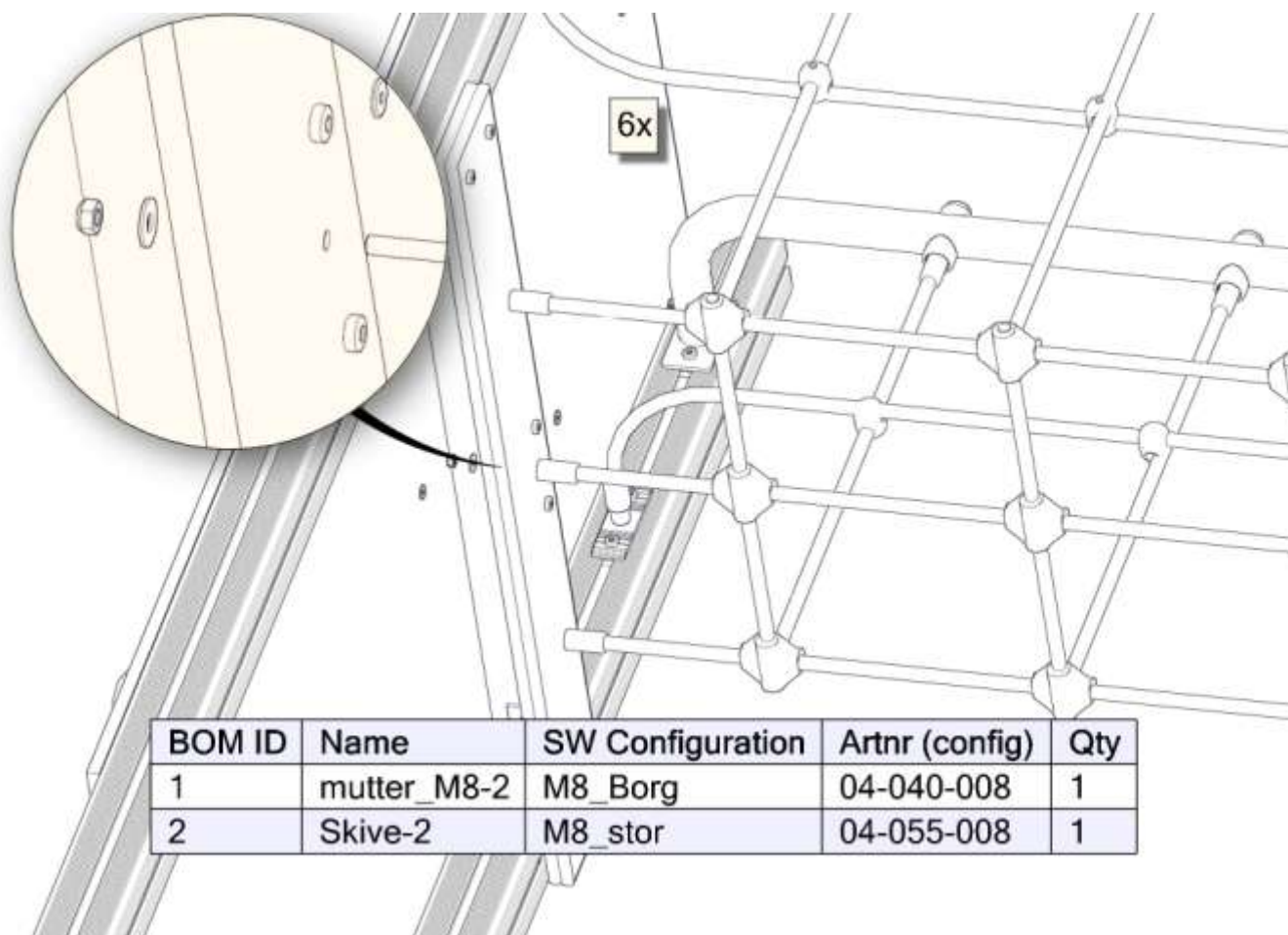



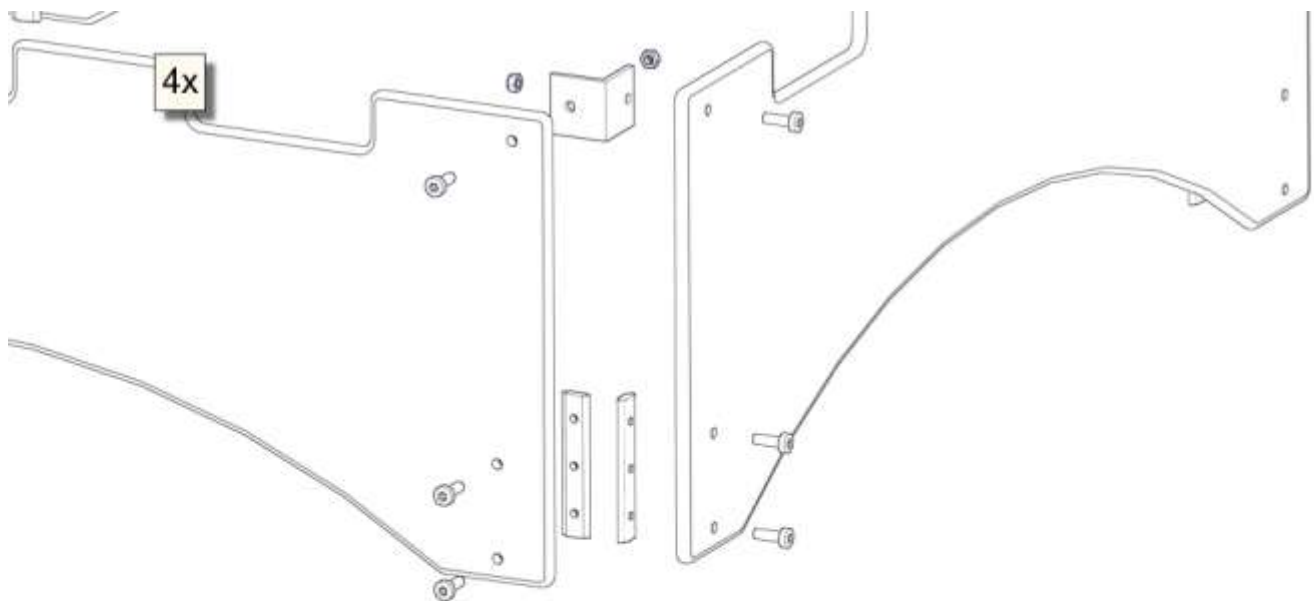
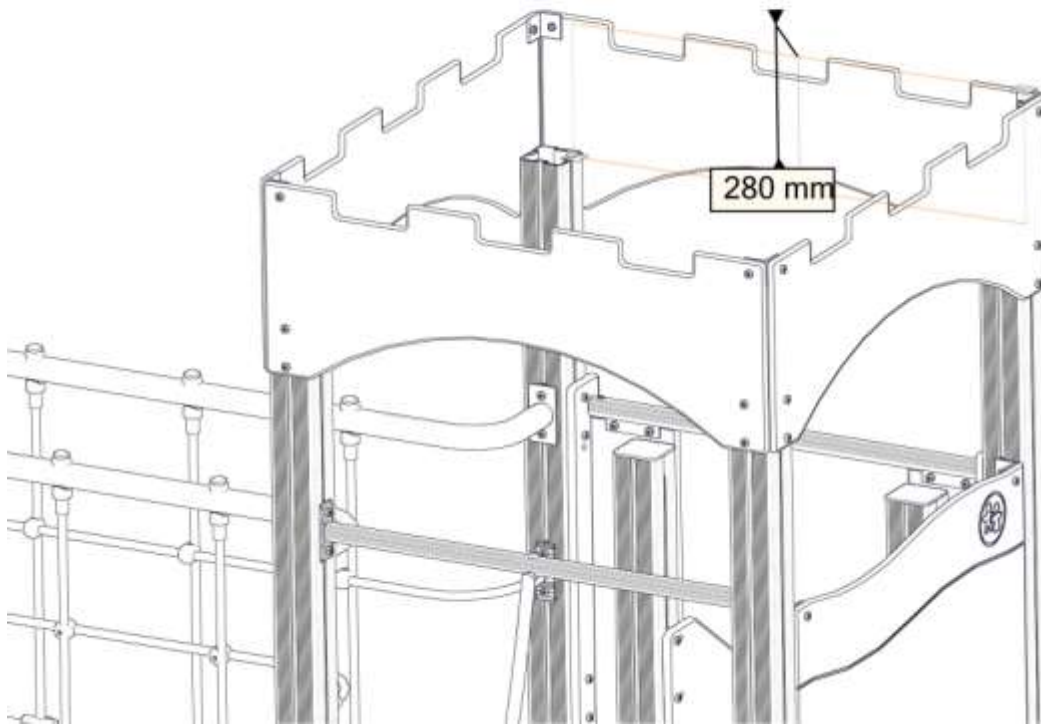



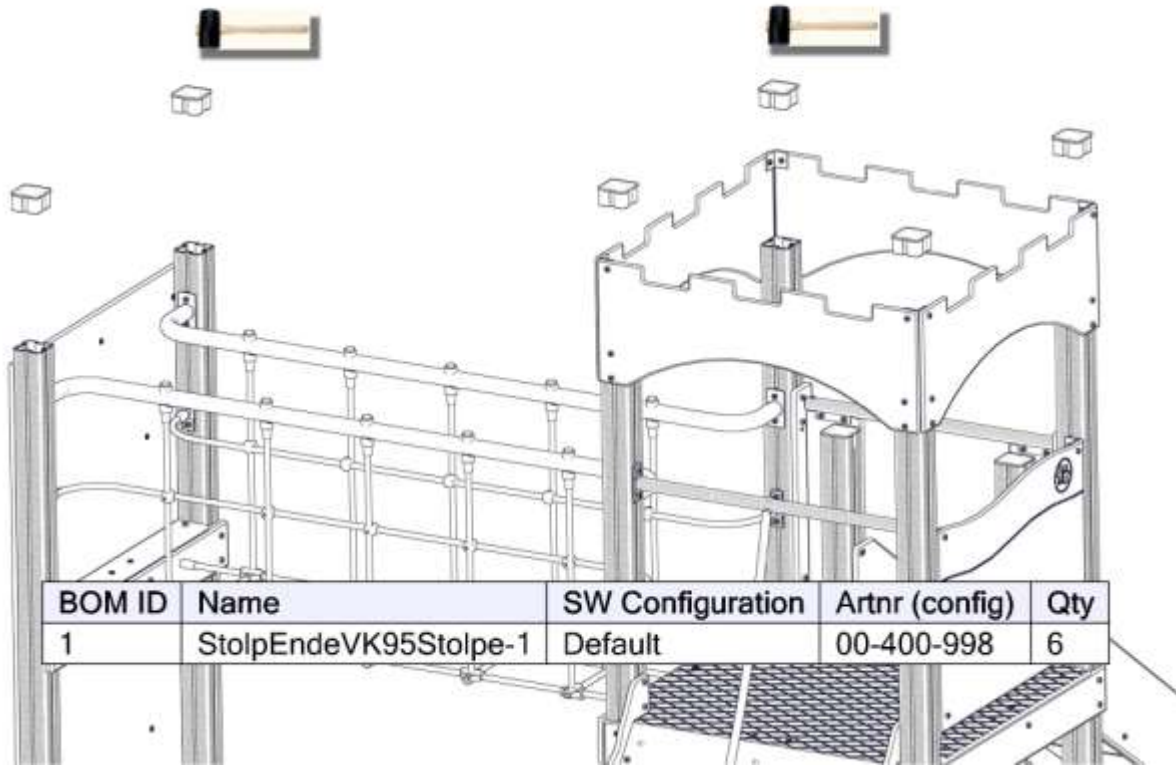



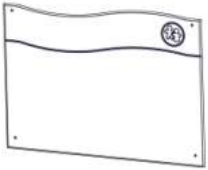
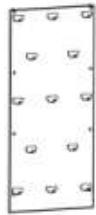

BOM ID	Name	SW Configuration	Artnr (config)	Qty
1	mutter_M8-2	M8_Borg	04-040-008	1
2	Skive-2	M8_stor	04-055-008	1









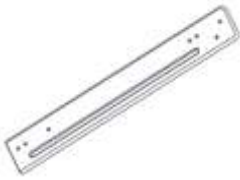

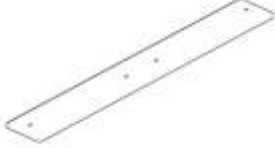

BOM ID	Name	SW Configuration	Artnr (config)	Qty
4	50x50x5-1	9mm	04-075-050	1
3	brikke_SFA5116-1	120_3T	04-060-120	2
2	mutter_M8-	M8_Borg	04-040-008	2
1	Torxm8-	TXM8x25	04-000-025	6



Før utstyret tas i bruk / Before play begins / Innan lekredskapet tas i bruk	
N	<ul style="list-style-type: none"> ● Påse at fallunderlag er utlagt i henhold til gjeldende regler eller vår anbefaling ● Fjern alle monteringshjelpemidler (rester av betong, planker, paller, plast, og lignende) ● Før utstyret tas i bruk, burde man sjekke at det ikke er fare for at anorakksnorer og lignende som kan hekte seg fast noen steder på lekeapparatet. (Vedlagte snor med dobbe (kneledd) kan brukes til å sjekke at dette er i orden. Se vedlagte veiledning for bruk av denne. Dette gjøres for å oppdage eventuelle feilmonteringer.?) ● NB! Bør stå i 2-3 dager før bruk
UK	<ul style="list-style-type: none"> ● Make sure the area and depth of safer surfacing are according to the current standard, or to the manufacturer's recommendation ● Make sure all tools and surplus materials are removed before play begins ● PS! When complete, allow 2-3 days for the concrete to set before use
S	<ul style="list-style-type: none"> ● Kontrollera att fallunderlag är utlagt enligt gällande regler eller vårt rekommendation ● Ta bort alla monteringshjälpmedel (rester av betong, plankor, pallar, plast och liknande) ● Innan lekredskapet används, kontrollera att anoracksnoddar eller kläder/delar av kläder eller liknande inte kan fastna i några delar på redskapet. (Den bipackade "knävringen" kan man med fördel användas för denna kontroll. ● Detta görs för att upptäcka eventuella felmonteringar.)

Boltepakker for / Boltpackage for / Bultpaket för			Sign. _____
3		VK95 L=2900 2 600-2300 00-400-010	Gulv 1 1160x1160x15 00-400-300
		VK95 L=3235 4 600-2635 00-400-009	
		VK95 L=640 2 01-126-005	
	Vegg 1 940x686x12 01-125-002		Klatrevegg 1 00-400-720
	Sprosse 4 1130x145x15 Med hull poly- fix nett 01-400-112		Systembane 1400 1 40-142-101
	Sprosse 3 1130x145x15 01-400-108		Rør rett 2 07-500-027
	Tak borg 4 01-400-502		Nett rett brua 1 07-500-043
	Sideplate portal 1 Høyre 01-126-001		Frontplate portal 2 01-126-003
	Sperrerør portal 1 01-126-004		Side plate portal 1 Venstre 01-126-002

Boltepakker for / Boltpackage for / Bultpaket för		Sign. _____.
	Opptreksplate 1 01-129-112	Feste HPL 2 01-129-113
	Sperrerør med kjetting 1 00-126-500	U-profiel 1 02-500-086
	Stålforankring 2 01-129-114	Fundametplate 4 00-003-106
	Gulv del 1 00-400-381	Eventuelt fundament 6

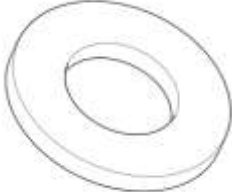
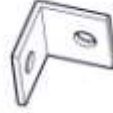
Boltepakker for / Boltpackage for / Bultpaket för			Sign. _____		
	Torx M8x12 04-000-012	5	Brikke 50-1T 04-060-050	14	
	Torx M8x16 04-000-016	6	Brikke 120-3T 04-060-120	30	
	Torx M8x20 04-000-020		Brikke 150-3T 04-060-150		
	Torx M8x25 04-000-025	48	Brikke 160-3T 04-060-160		
	Torx M8x30 04-000-030	27	Låsemutter M8 04-040-008	45	
	Torx M8x35 04-000-035	48	Låsemutter M10 04-040-010	10	
	Torx M8x40 04-000-040	3			
	Torx M8x45 04-000-045	10			
Torx M8x50 04-000-050	8		Stålforankring 00-100-310	2	
	Møbelknapp M8x13x17 04-030-011 04-030-016	14		Hylsemutter M8 12-38 04-018-060	4
	Plast rondell 05-300-036	10		Plast rondell 05-300-036	20
	Plast plug 9-11mm 04-090-002	20		Plug spor 00-400-980	8
	Skive M8 04-050-008	39		Vinkel 35x35x35 04-070-036	4
	Skive M8 04-055-008			Vinkel 50x50x50 04-075-050 9mm	8
	Skive M10 Poly 04-055-036	20		Vinkel 50x50x50 04-070-050 11mm	7