

N

**Monteringsanvisning**

EN

**Assembly Instructions**

S

**Monteringsanvisning**

Produkt nr. / Product no. / Produkt nr.

**11-145-262****Trestruktur/ Grå**

Ord. nr. \_\_\_\_\_

Dato. \_\_\_\_\_

Sign. \_\_\_\_\_

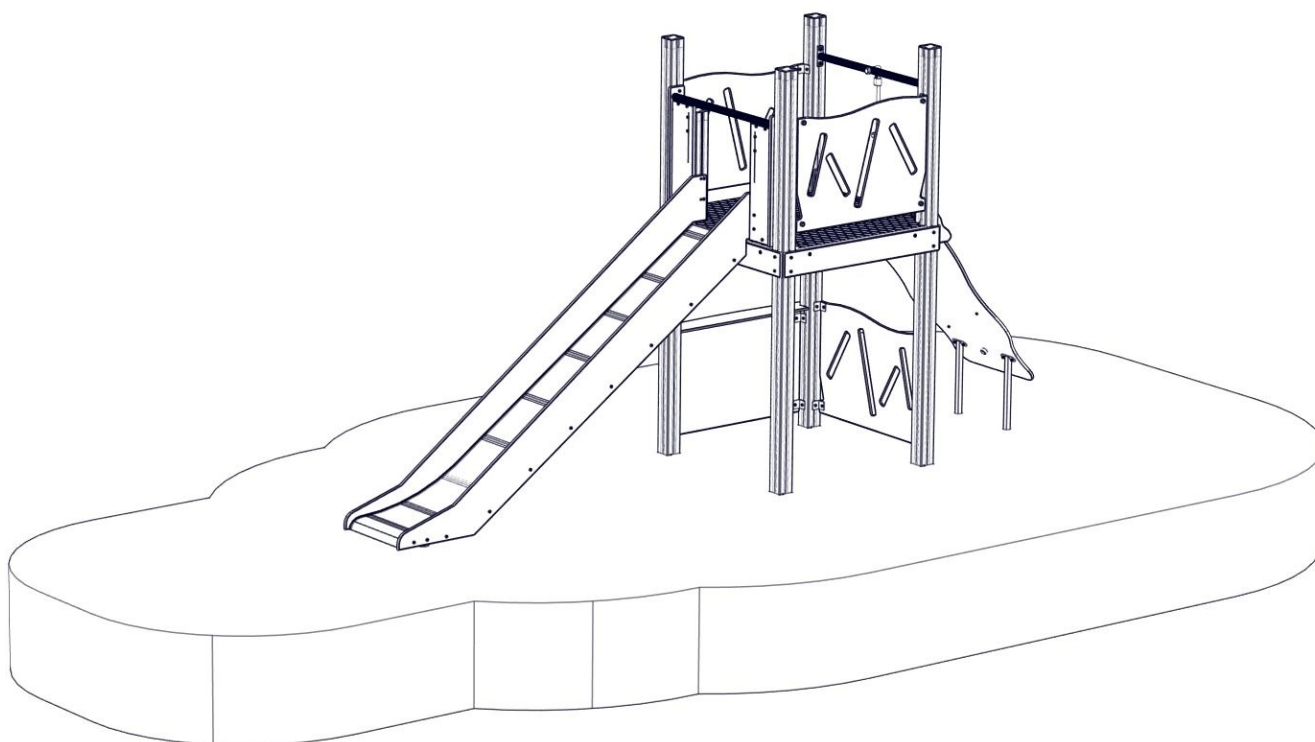
**søve**

Søve AS  
Grønnvoldveien 290  
3830 Ulefoss - Norway  
Tlf: +47 35 94 65 65  
[www.sove.no](http://www.sove.no)

**søve**

Søve AB  
EA Rosengrensgatan 32  
421 31 Västra Frölunda  
Phone: +46 (0)31 773 97 00  
[www.sove.se](http://www.sove.se)

## Monteringstips / Assembly Advice / Monteringsstips

N

- Les monteringsanvisningen nøye før montering.
- Monter elementene i rekkefølgen som vist.
- Boltene bør ikke skrues for hardt til før alt er montert, vatret og loddet. Skru så boltene til.
- NB! Ved bruk av drill, kan boltene ryke.
- På grunn av at solen kan gjøre rutsjeflaten veldig varm, bør rutsjebanens utløp vende mot nord-øst eller nord-vest.
- Er lekeutstyret plassert i naturlige ferdselstraséer må området sikres mot gjennomgang.
- Innspringningshinder bør vurderes rundt lekeapparater hvor det er stor bevegelse, f.eks. ved huskestativ.
- Det bør være fritt innsyn til lekeutstyr som er beregnet for barn under 3 år.

**NB! Under monteringsarbeidet må utstyr, som ikke er forankret forsvarlig i bakken, sikres slik at det ikke velte.**

**Området må avstenges under montering av apparatene med sperrebånd eller lignende.**

EN

- Read the instruction carefully before assembling the play unit.
- Assemble the components in the sequence shown in these instructions. Fixings must not be fully tightened during assembly. Before casting the foundations, the structure must be level and plumb, at which point all fixings are tightened. PS! If use of drill, the bolts may be wrecked.
- Avoid positioning the slide facing due south because of overheating – ideal positions are facing north-east or north-west. Secure the construction-area to prevent people from walking through it.
- Consider installing barriers around play-equipment which gives rise to a lot of activity – i.e. swings.
- Ensure that clear vision is possible across the play area so that supervision is possible from any position, particularly where children under 3 years of age will be playing.

**NB! During assembly of the equipment, ensure that all structures are securely propped, especially when left overnight. Also ensure that equipment is supported**

**Monteringstips / Assembly Advice / Monteringsstips****S**

- Läs monteringsanvisningen noga före montering.

- Montera delarna i den ordningen som anvisas
- Skruvarna bör inte skruvas för hårt tills allt är monterat, i våg och lodat.









OBS! Används elektrisk skruvdragare, kan bulten gå sönder. Hårdra därför manuellt!

- Solen kan göra att rutchbanan blir väldigt varm. Banans nedfart rekommenderas att vändas i norrlig riktning
- Om lekplatsen placeras vid en gångväg mm bör området säkras mot genomfart av gående och cyklister.
- Insprängningshinder bör placeras runt lekutrustning med stor rörelse, t ex, gungställning.
- Det bör vara fri insyn till lekutrustning beräknat till barn under 3 år.

**OBS! Under monteringsarbete bör utrustningen som inte ska förankras i marken, ställs så att den inte kan välta.**

**Området måste spärras när lekutrustningen byggs upp, med avspärrningsband eller liknande.**

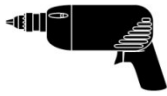
**Nødvendig verktøy / Tools required / Nödvändiga verktyg**

<p>(N)</p> <p>(EN)</p> <p>(S)</p>	<p>(A)</p> 	<p>(B)</p>  <p>Torx Nr 45</p>	<p>(C)</p> <p>5 mm 6 mm</p> 	<p>(D)</p> 	<p>(E)</p> 
		<p>Metermål Metric measure Tumstock</p> 	<p>Ø11mm Bor Ø11mm Drill Ø11mm Borr</p> 	<p>Merkebånd Mark ribbon Märkeband</p> 	<p>13 + 17mm</p> 

**Nødvendig antall personer / Number of persons required / Rekommenderad antal personer**





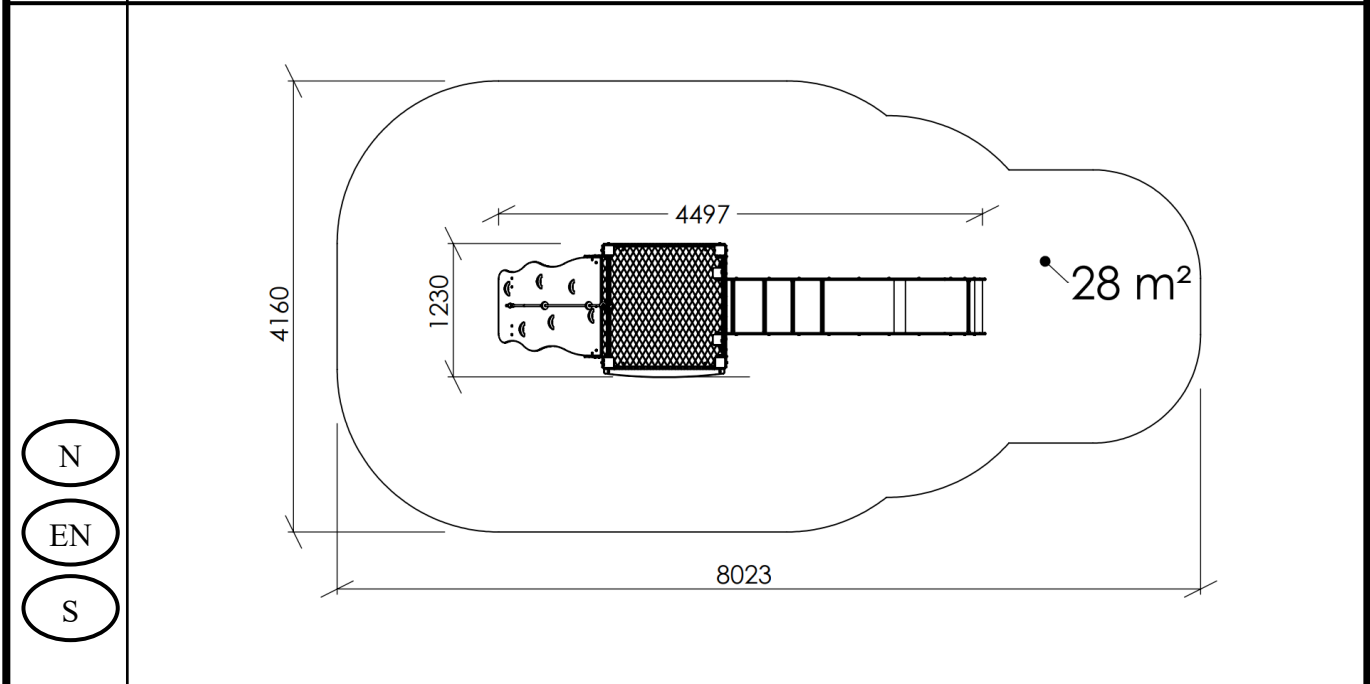

**Anbefalt arealbehov ved montering / Recommended working space / Rekommenderad arealbehov vid montering**



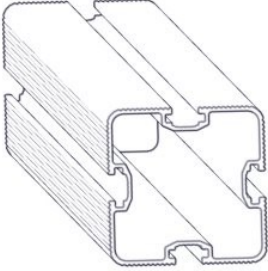

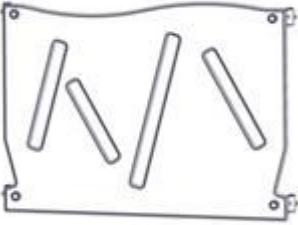

**Boltepakker for / Boltpackage for / Bultpaket för**

Sign. \_\_\_\_\_

Nome, Trestruktur 11-145-262	Navn	Artnr/ dimensjon	Ant	Lev
	Stolpe 95x95 Lengde = 600-2430 / 3030 Sort	SFA5117/1	4	
	Gulv Portal-0-0-0 1160 x 1160 x 15 Grå	00-400-299K (se egen del- montering)	1	
	Sprosse standard 1130 x 145 x 15 Grå	00-400-104K (se egen del- montering)	4	
	Rekkverk 940 x 868 x 12 Trestruktur	01-125-021K (se egen del- montering)	3	
	Rekkverk butikkdisk 940 x 630 x 12 Trestruktur	01-125-015K (se egen del- montering)	1	
	Butikkdisk 1122 x 175 x 12 Grå	01-125-016K (se egen del- montering)	1	

**Boltepakker for / Boltpackage for / Bultpaket för**

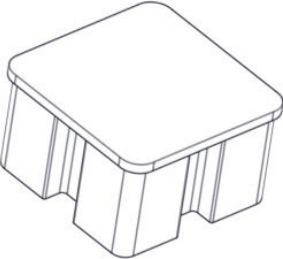
Sign. \_\_\_\_\_

Nome, Trestruktur 11-145-262	Navn	Artnr/ dimensjon	Ant	Lev
	Rutsjebane inkl. portal Gulvhøyde = 1.4m Trestruktur / Grå	40-142-104K (se egen del- montering)	1	
	Opptrekkplate CC1035 Grå	01-129-117K (se egen del- montering)	1	
	Endelokk 95 x 95 stolpe Sort	00-400-998	4	
	Produktmerke	00-100-400 (montert hos Søve)	0	

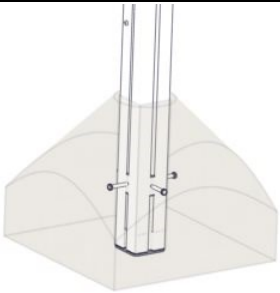
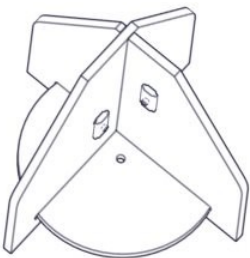
<b>Boltepakker for / Boltpackage for / Bultpaket för</b>		Sign. _____.		
Nome, Trestruktur 11-145-262	Navn	Artnr/ dimensjon	Ant	Lev
	<b>Fundament Støp</b>			
	Støpefundament 95 x 95 stolpe	00-003-110K (se egen del- montering)	4	
	<b>Fundament Nedgravning</b>			
	Nedgravningsfundament 95 x 95 stolpe	00-003-004K (se egen del- montering)	4	

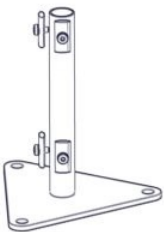
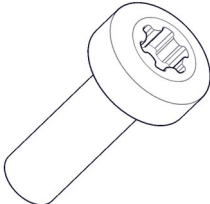
<b>Boltepakker for / Boltpackage for / Bultpaket för</b>		Sign. _____		
Nome, Trestruktur 11-145-262	Navn	Artnr/ dimensjon	Ant	Lev
	<b>Overflate fun- damentering</b>			
	Fundament 95x95 stolpe for betongdekke	00-003-125K (Se egen del- montering)	4	
	<b>Deler som må Endres, Changed parts</b>			
	opptreksplate forankring	01-129117K	(2)	
	rustjebane forankring	40-142-104K	(2)	
	Stolpene kappes	SFA5117/1	(4)	
	Bruk kortere bolter når du monterer den nederste delen av veggene	04-000-016	4	



**Fundamentering med betong / Foundation concrete / Förankring med betong**

- (N) Komprimert masse Ref NS-EN 1176-1 §4.2.8.5
- (EN) Compressed mass
- (S) Komprimerad massa



- (N) Bakkenivå
- (EN) Ground level
- (S) marknivå

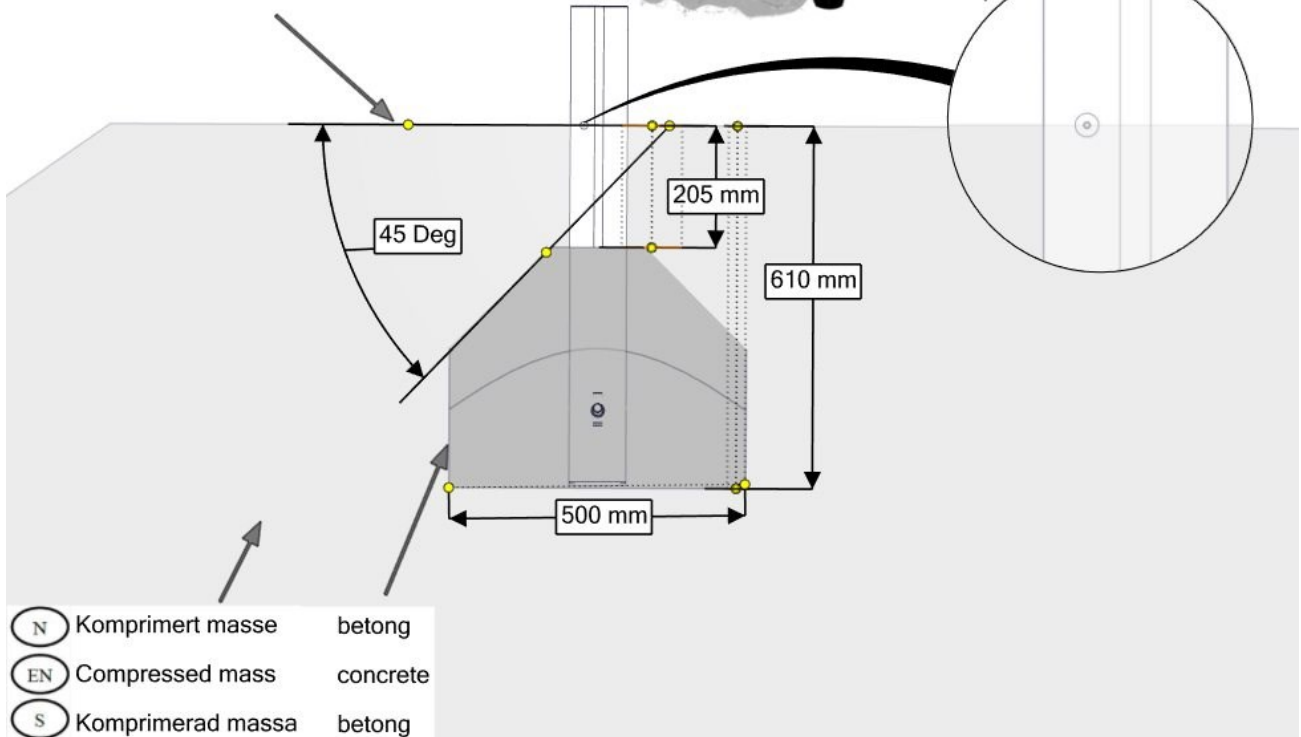

- (N) Komprimert masse betong
- (EN) Compressed mass concrete
- (S) Komprimerad massa betong

**Fundamentering uten betong / Foundation without concrete / Förankring utan betong**

- (N) Støtdempende materialer Ref NS-EN 1176-1 §4.2.8.5
- (EN) Impact attenuating materials
- (S) Stötdämpande material

- (N) Bakkenivå
- (EN) Ground level
- (S) Marknivå

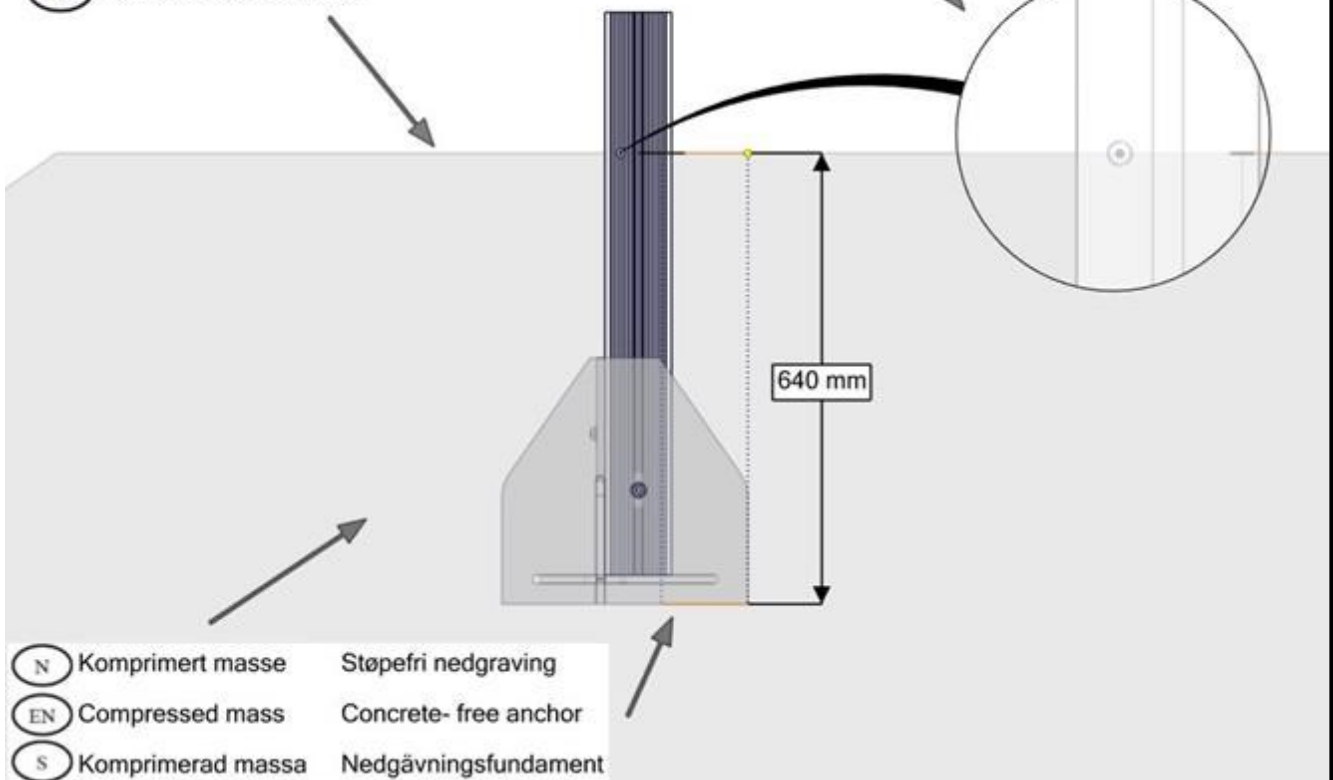

- (N) Komprimert masse Støpefri nedgraving
- (EN) Compressed mass Concrete-free anchor
- (S) Komprimerad massa Nedgävningsfundament

**Overflatemontering, Surface mounting, Ytmontering**

Ref  
NS-EN 1176-1  
§4.2.8.5

(N) (EN) (S)  
Bakkenivå Ground level marknivå

Tykkelse/Thickness

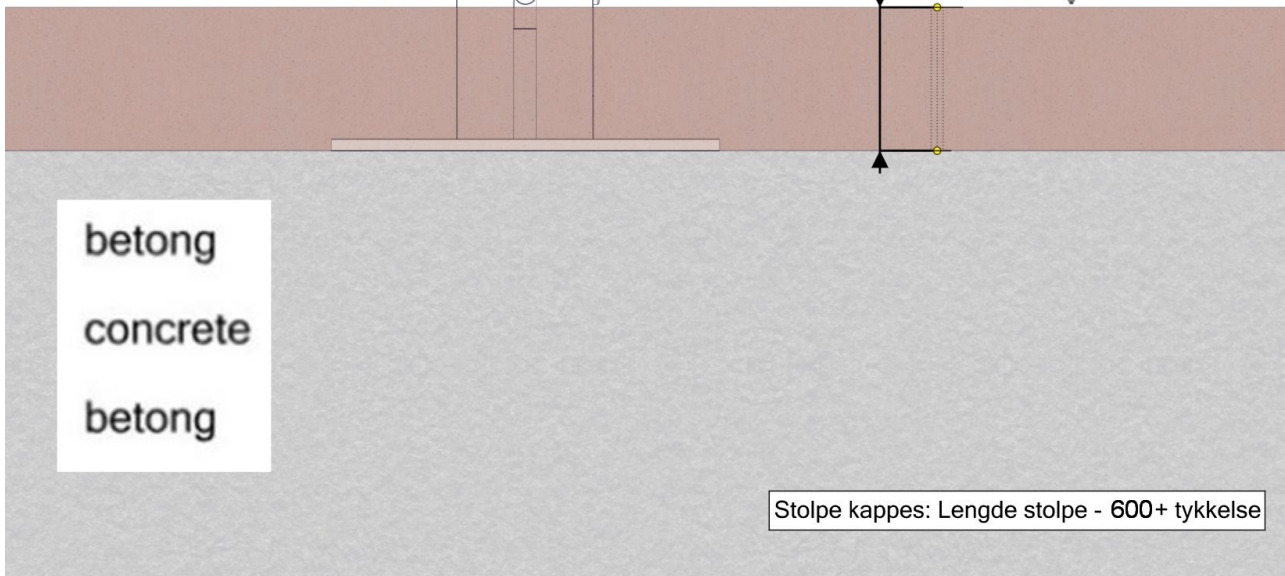

betong  
concrete  
betong

Stolpe kappes: Lengde stolpe - 600+ tykkelse

Når du har overfalte monteringsfundamenter bruk korte skurer på nedeste festepunkter.

If you are using 0-level anchors use short bolt for mounting lower lower parts

04-000-016

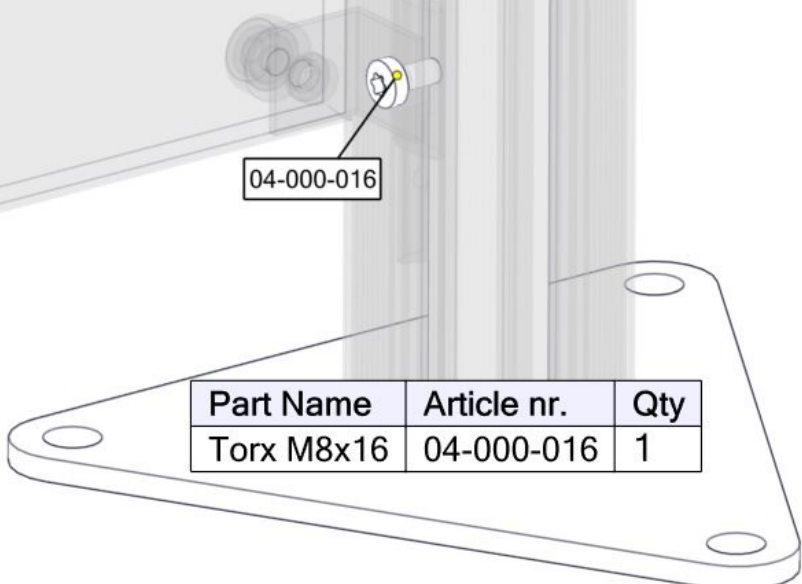

Part Name	Article nr.	Qty
Torx M8x16	04-000-016	1

N	<p>Bolten skrues HELT igjennom aluminiumen. Maks moment: 30Nm</p>
EN	<p>The bolt must be tightened in to the post, so that it pierces the aluminium Max torque: 30Nm</p>
S	<p>Bulten skruvas HELT genom aluminiumen. Maks vridmoment: 30Nm</p>

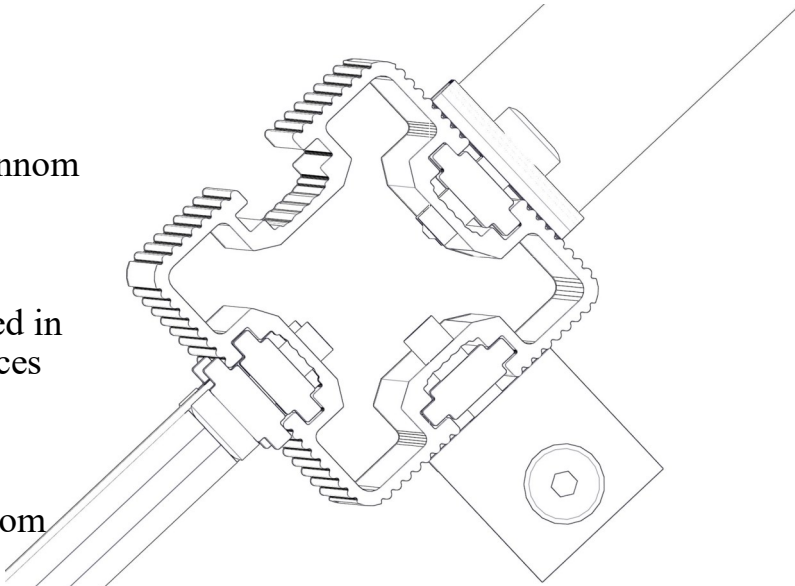

NO		Betongkvalitet	C25/30		
SE		Betongkvalitet			
EN		Concrete quality			
NO		Mengde betong		0,4	m <sup>3</sup>
SE		Mängd betong			
EN		Amount of concrete			
NO		Fundament størrelse	0,5 x 0,5 x 0,4	m	
SE		Stiftelsestorlek			
EN		Foundation size			
NO		For sikkerhet må fundamentene med sand eller myk jord være minst 50% større i areal			
SE		För säkerheten måste grunden med sand eller mjuk jord vara minst 50% större i området			
EN		For safety, the foundations with sand or soft soil must be at least 50% larger in area			
NO		Tyngste element	40-142-103	49,1	Kg
SE		Tyngsta element			
EN		Heaviest element			
NO		Største element	40-142-103	3,01x0,52x0,35	m
SE		Största element			
EN		Biggest element			

**Fallhøyder / Free height of fall / Fallhöjder**

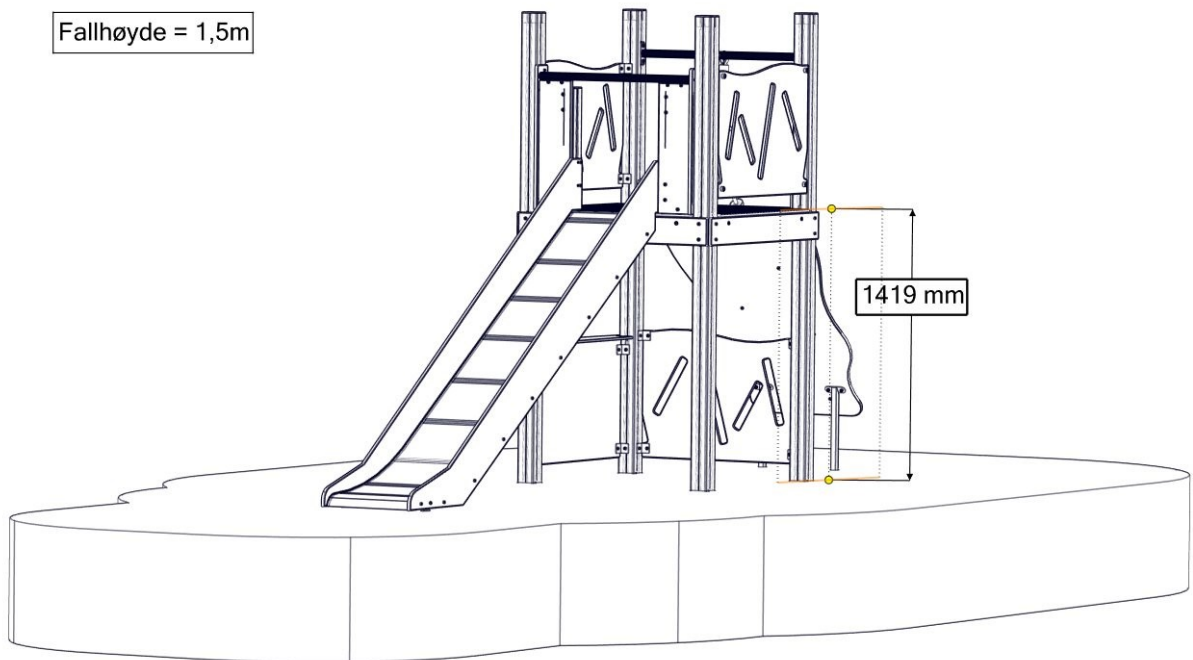

**Sikkerhetszone / Safety zone / Säkerhetszon**

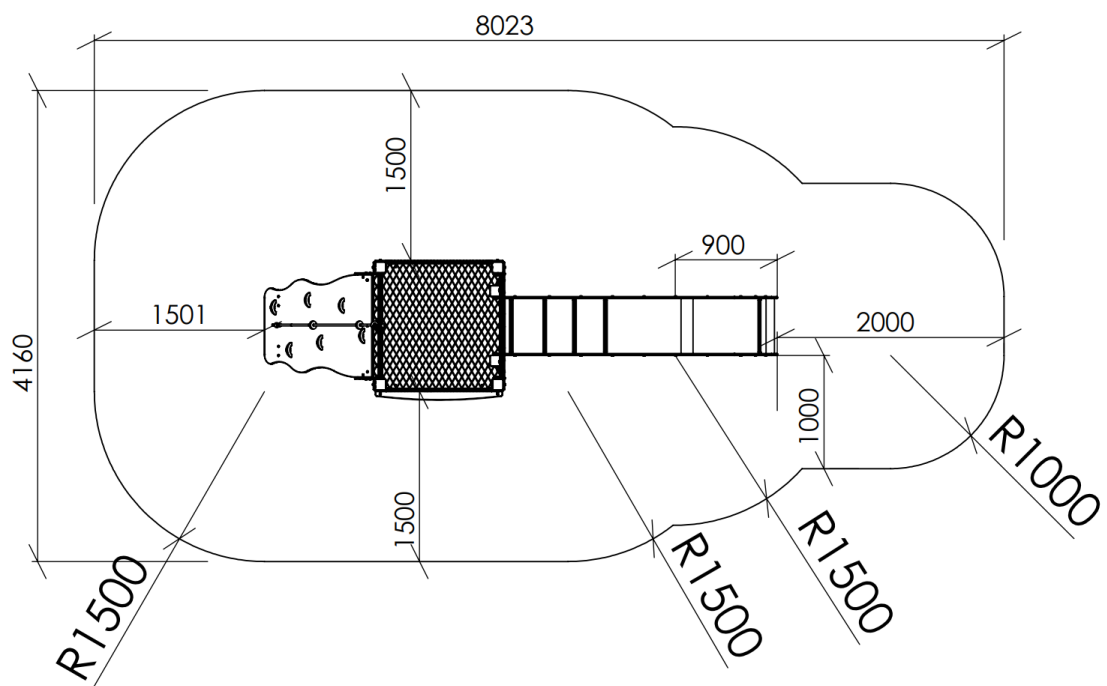

Plassering av forankringer / Ground plan / Placering av förankringar

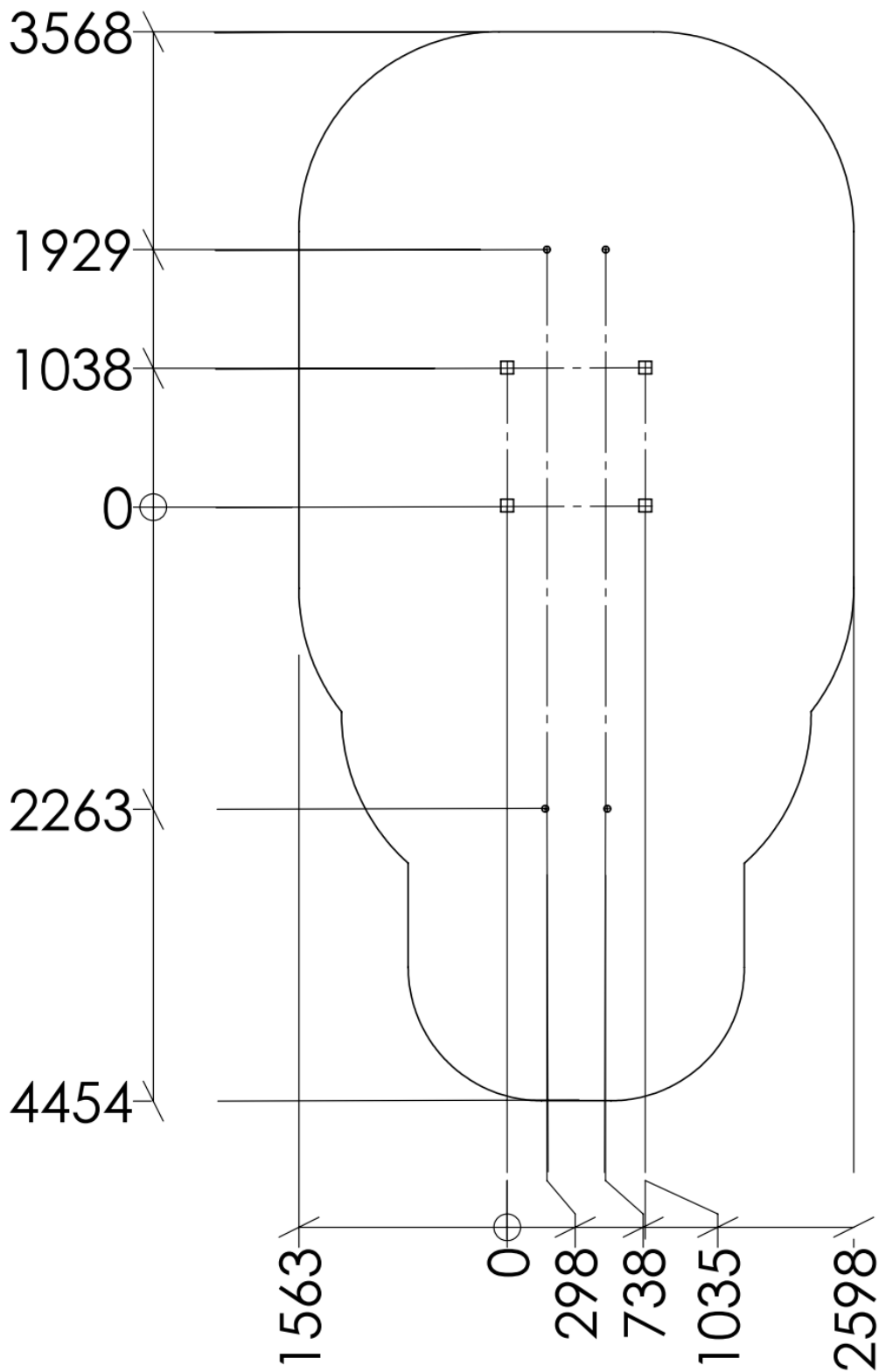

N

Alle mål er oppgitt i millimeter

EN

Scale measured in mm

S

Alla mått är i millimeter.

**Montering av lekeapparatet / Assembly instructions / Montering av lekredskapet**

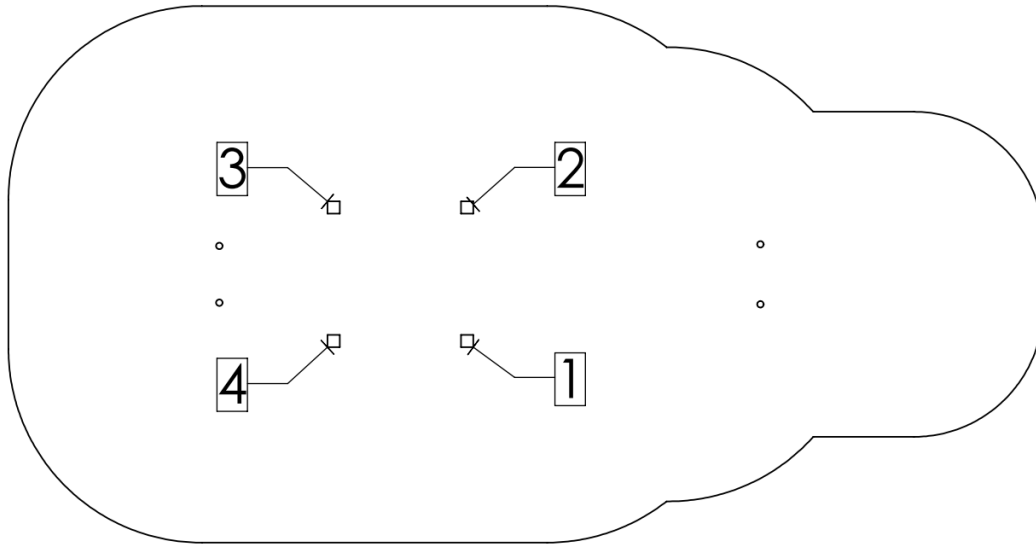

Se separat delmontering for detaljer  
 See separate assembly for details  
 Se separata delmontering för detaljer

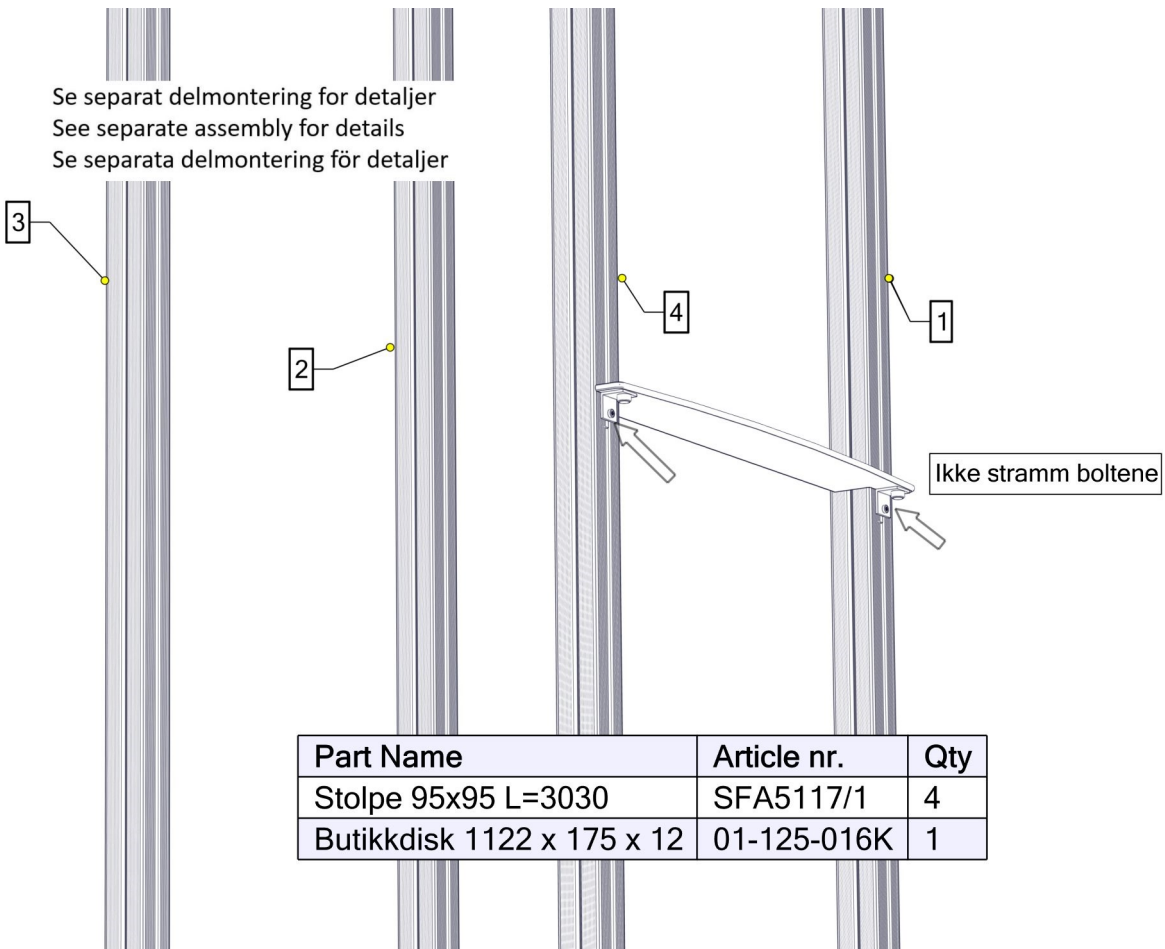

Part Name	Article nr.	Qty
Stolpe 95x95 L=3030	SFA5117/1	4
Butikkdisk 1122 x 175 x 12	01-125-016K	1

**Montering av lekeapparatet / Assembly instructions / Montering av lekredskapet**

Se separat delmontering for detaljer  
 See separate assembly for details  
 Se separata delmontering för detaljer

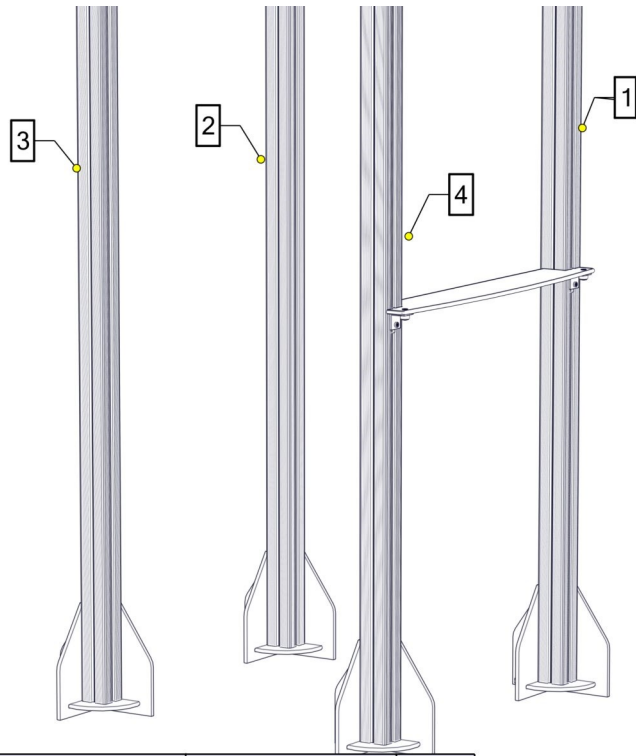

Part Name	Article nr.	Qty
Nedgravingsfundament 95x95	00-003-004K	4

Se separat delmontering for detaljer  
 See separate assembly for details  
 Se separata delmontering för detaljer

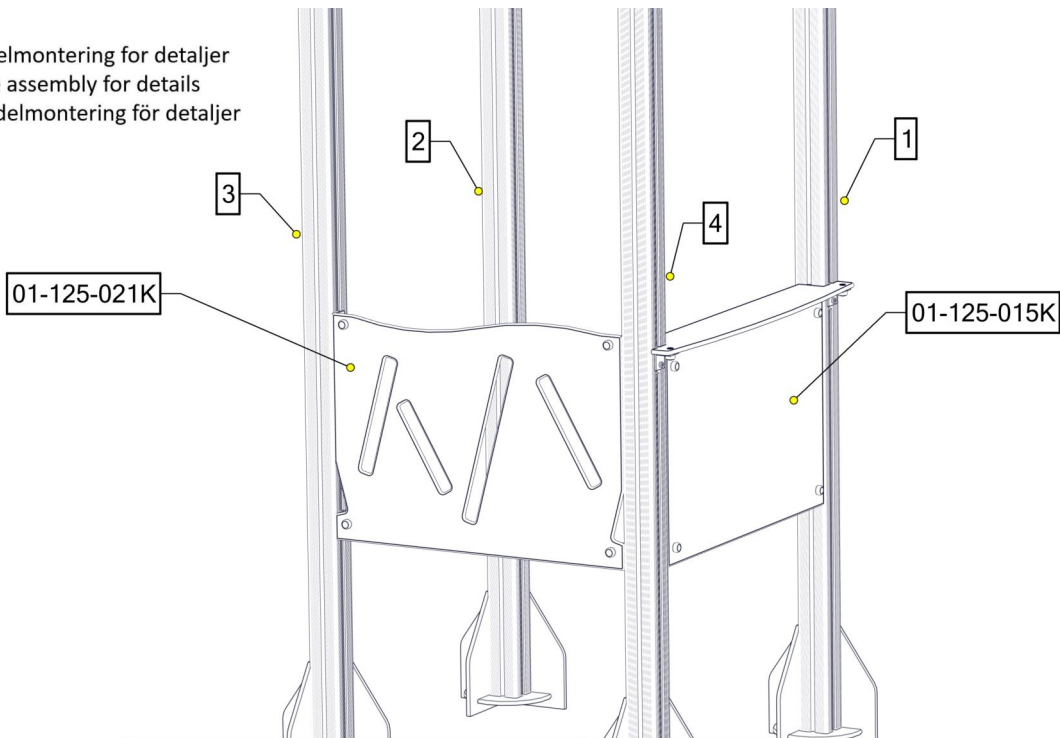

Part Name	Article nr.	Qty
Rekkverk 940x868x12	01-125-021K	1
Rekkverk butikkdisk 940x630x12	01-125-015K	1

## Montering av lekeapparatet / Assembly instructions / Montering av lekredskapet

Se separat delmontering for detaljer  
 See separate assembly for details  
 Se separata delmontering för detaljer

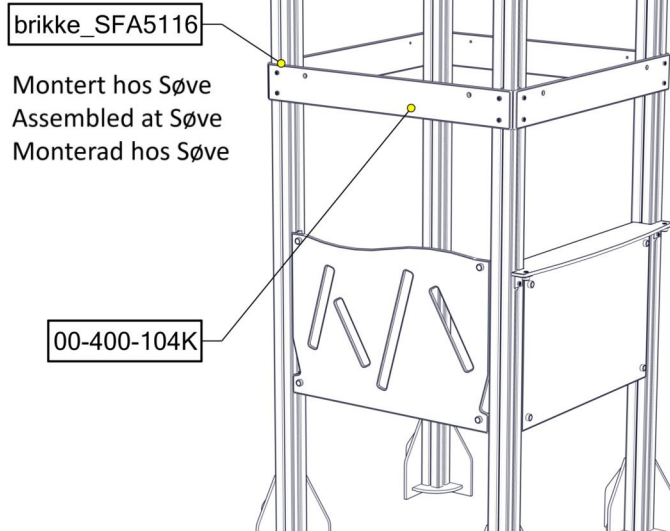

Montert hos Søve  
 Assembled at Søve  
 Monterad hos Søve

Part Name	Article nr.	Qty
Sprosse std 1130x145x15 for gulv	00-400-104K	4

Se separat delmontering for detaljer  
 See separate assembly for details  
 Se separata delmontering för detaljer

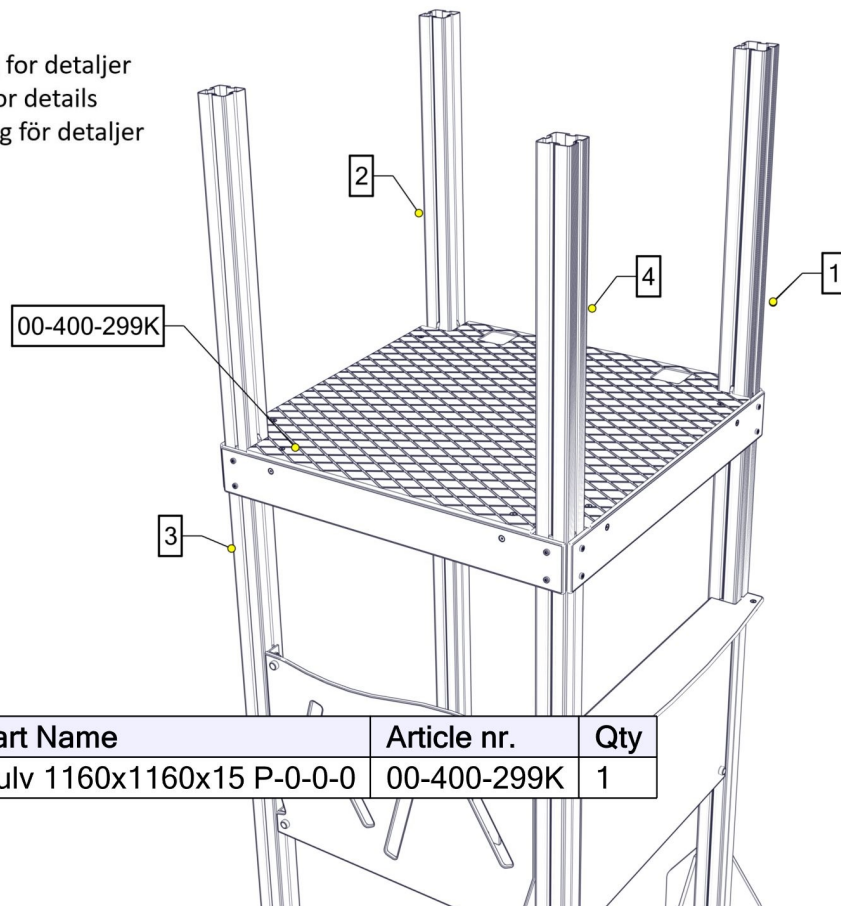

Part Name	Article nr.	Qty
Gulv 1160x1160x15 P-0-0-0	00-400-299K	1



## Montering av lekeapparatet / Assembly instructions / Montering av lekredskapet

Se separat delmontering for detaljer  
 See separate assembly for details  
 Se separata delmontering för detaljer

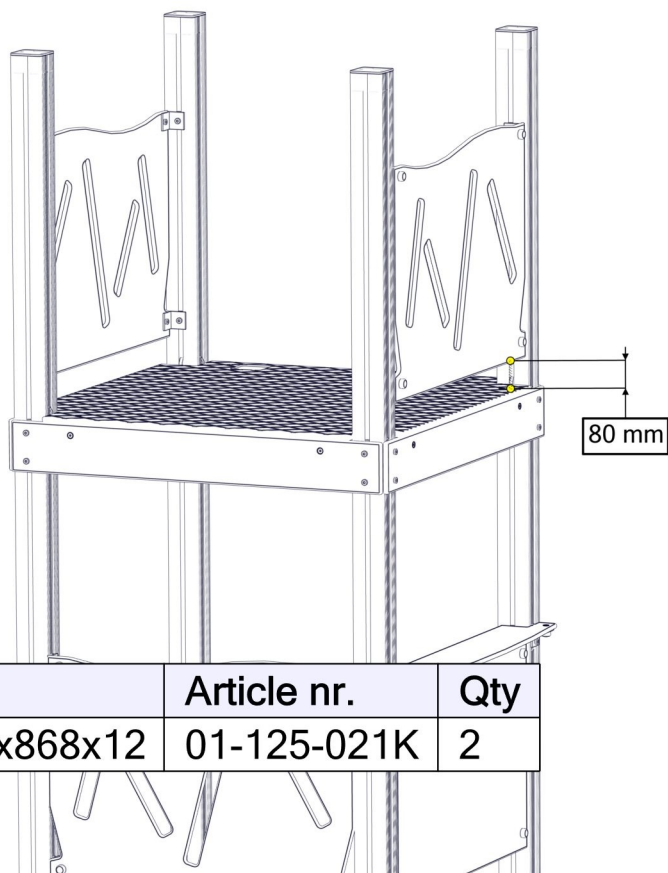

Part Name	Article nr.	Qty
Rekkverk 940x868x12	01-125-021K	2

Se separat delmontering for detaljer  
 See separate assembly for details  
 Se separata delmontering för detaljer

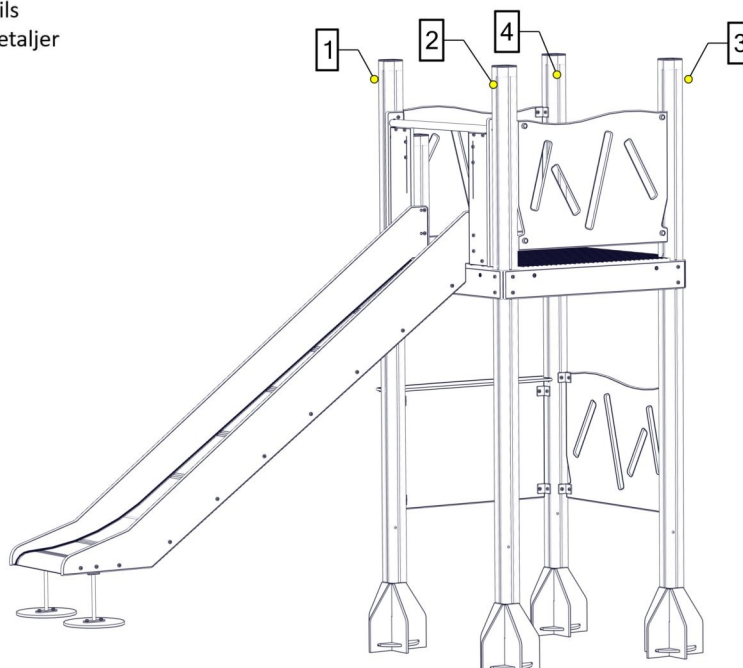

Part Name	Article nr.	Qty
Rustjebane H=1,4M inkl. portal	40-142-104K	1

## Montering av lekeapparatet / Assembly instructions / Montering av lekredskapet

Se separat delmontering for detaljer  
 See separate assembly for details  
 Se separata delmontering för detaljer

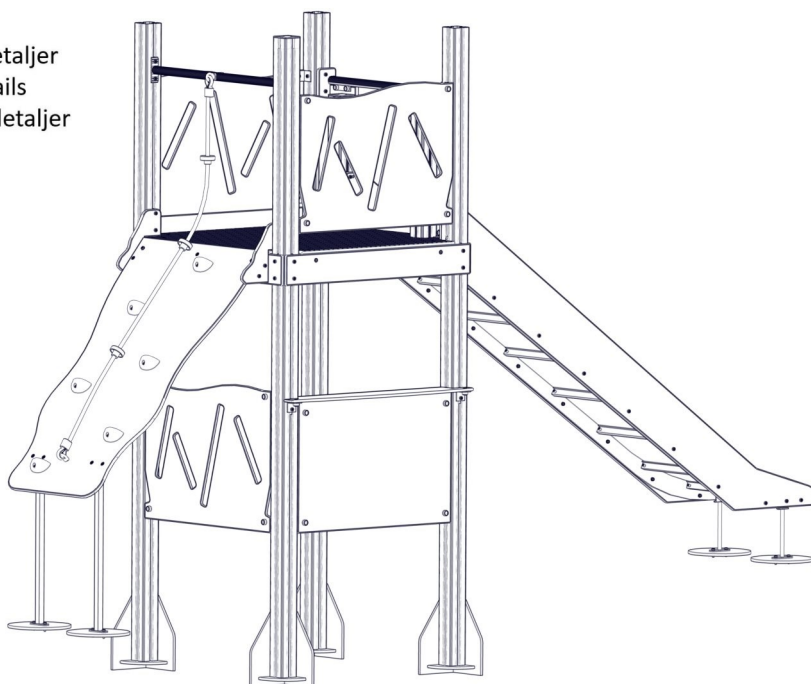

Part Name	Article nr.	Qty
Opptreksplate CC1035	01-129-117K	1

Se separat delmontering for detaljer  
 See separate assembly for details  
 Se separata delmontering för detaljer

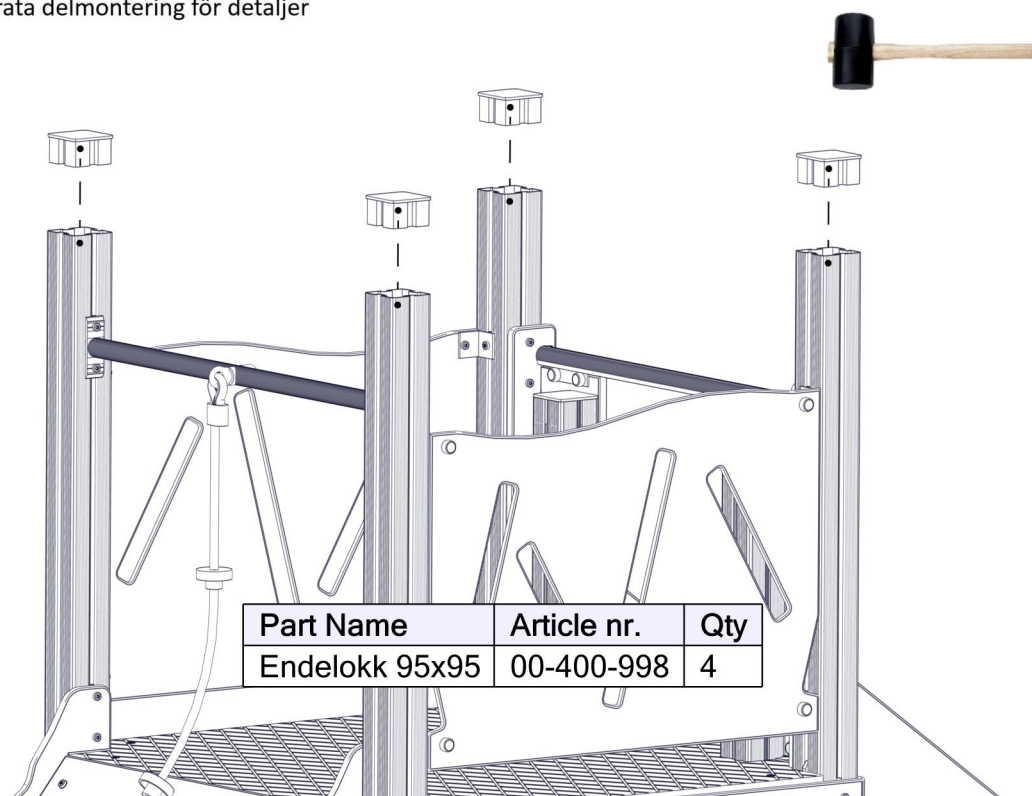







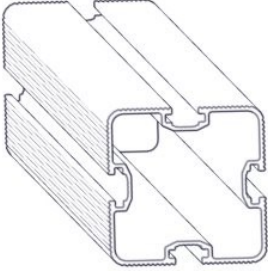

Part Name	Article nr.	Qty
Endelukk 95x95	00-400-998	4

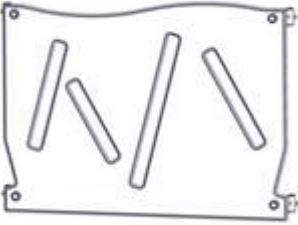
<b>Før utstyret tas i bruk / Before play begins / Innan lekredskapet tas i bruk</b>	
<b>N</b>	<ul style="list-style-type: none"> <li>● Påse at fallunderlag er utlagt i henhold til gjeldende regler eller vår anbefaling</li> <li>● Fjern alle monteringshjelpemidler ( rester av betong, planker, paller, plast, og lignende)</li> <li>● Før utstyret tas i bruk, burde man sjekke at det ikke er fare for at anorakksnorer og lignende som kan hekte seg fast noen steder på lekeapparatet. (Vedlagte snor med dobbe (kneledd) kan brukes til å sjekke at dette er i orden. Se vedlagte veiledning for bruk av denne. Dette gjøres for å oppdage eventuelle feilmonteringer.?)</li> <li>● NB! Bør stå i 2-3 dager før bruk</li> </ul>
<b>EN</b>	<ul style="list-style-type: none"> <li>● Make sure the area and depth of safer surfacing are according to the current standard, or to the manufacturer's recommendation</li> <li>● Make sure all tools and surplus materials are removed before play begins</li> <li>● PS! When complete, allow 2-3 days for the concrete to set before use</li> </ul>
<b>S</b>	<ul style="list-style-type: none"> <li>● Kontrollera att fallunderlag är utlagt enligt gällande regler eller vårt rekommendation</li> <li>● Ta bort alla monteringshjälpmedel (rester av betong, plankor, pallar, plast och liknande)</li> <li>● Innan lekredskapet används, kontrollera att anoracksnoddar eller kläder/delar av kläder eller liknande inte kan fastna i några delar på redskapet. (Den bipackade "knävringen" kan man med fördel användas för denna kontroll.</li> <li>● Detta görs för att upptäcka eventuella felmonteringar.)</li> </ul>

**Boltepakker for / Boltpackage for / Bultpaket för**

Sign. \_\_\_\_\_

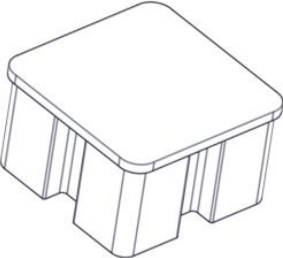
Nome, Trestruktur 11-145-262	Navn	Artnr/ dimensjon	Ant	Lev
	Stolpe 95x95 Lengde = 600-2430 / 3030 Sort	SFA5117/1	4	
	Gulv Portal-0-0-0 1160 x 1160 x 15 Grå	00-400-299K (se egen del- montering)	1	
	Sprosse standard 1130 x 145 x 15 Grå	00-400-104K (se egen del- montering)	4	
	Rekkverk 940 x 868 x 12 Trestruktur	01-125-021K (se egen del- montering)	3	
	Rekkverk butikkdisk 940 x 630 x 12 Trestruktur	01-125-015K (se egen del- montering)	1	
	Butikkdisk 1122 x 175 x 12 Grå	01-125-016K (se egen del- montering)	1	

<b>Boltepakker for / Boltpackage for / Bultpaket för</b>		Sign. _____		
<b>Nome, Trestruktur 11-145-262</b>	<b>Navn</b>	<b>Artnr/ dimensjon</b>	<b>Ant</b>	<b>Lev</b>
	Rutsjebane inkl. portal Gulvhøyde = 1.4m Trestruktur / Grå	40-142-104K (se egen del- montering)	1	
	Opptrekkplate CC1035 Grå	01-129-117K (se egen del- montering)	1	
	Endelokk 95 x 95 stolpe Sort	00-400-998	4	
	Produktmerke	00-100-400 (montert hos Søve)	0	

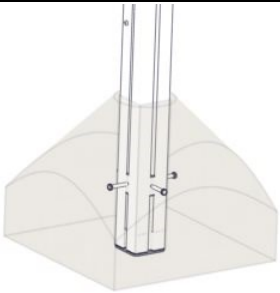
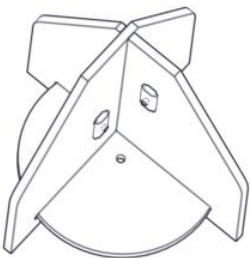
<b>Boltepakker for / Boltpackage for / Bultpaket för</b>		Sign. _____		
Nome, Trestruktur 11-145-262	Navn	Artnr/ dimensjon	Ant	Lev
	<b>Fundament Støp</b>			
	Støpefundament 95 x 95 stolpe	00-003-110K (se egen del- montering)	4	
	<b>Fundament Nedgravning</b>			
	Nedgravningsfundament 95 x 95 stolpe	00-003-004K (se egen del- montering)	4	

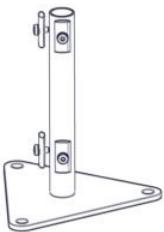
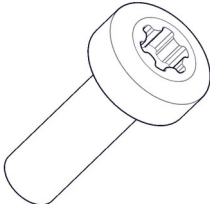
<b>Boltepakker for / Boltpackage for / Bultpaket för</b>		Sign. _____		
Nome, Trestruktur 11-145-262	Navn	Artnr/ dimensjon	Ant	Lev
	<b>Overflate fun- damentering</b>			
	Fundament 95x95 stolpe for betongdekke	00-003-125K (Se egen del- montering)	4	
	<b>Deler som må Endres, Changed parts</b>			
	opptreksplate forankring	01-129117K	(2)	
	rustjebane forankring	40-142-104K	(2)	
	Stolpene kappes	SFA5117/1	(4)	
	Bruk kortere bolter når du monterer den nederste delen av veggene	04-000-016	4	