

N

**Monteringsanvisning**

EN

**Assembly Instructions**

S

**Monteringsanvisning**

Produkt nr. / Product no. / Produkt nr.

**11-145-272****Trestruktur / Grå**

Ord. nr. \_\_\_\_\_

Dato. \_\_\_\_\_

Sign. \_\_\_\_\_

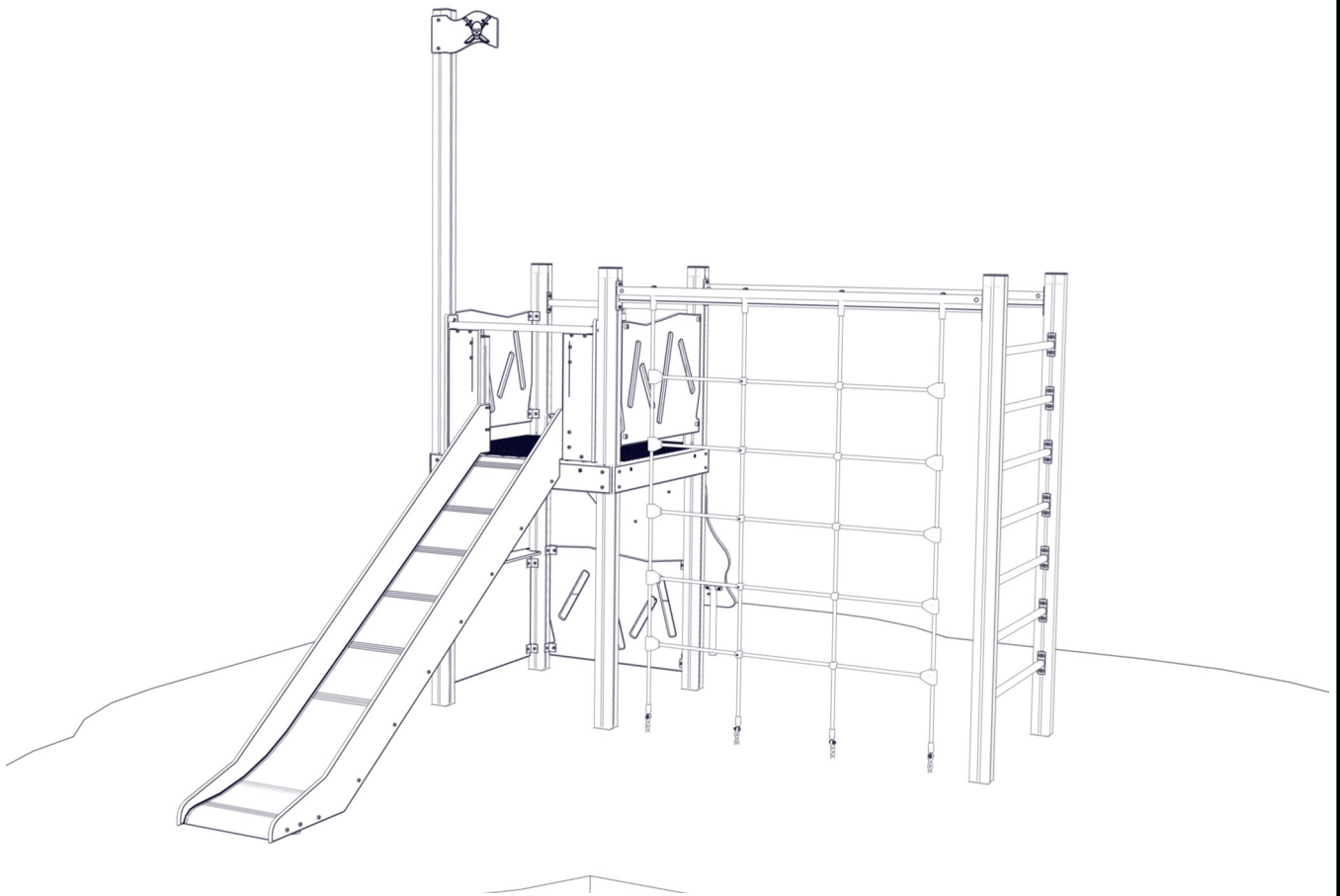
**søve**

Søve AS  
Grønnvoldveien 290  
3830 Ulefoss - Norway  
Tlf: +47 35 94 65 65  
[www.sove.no](http://www.sove.no)

**søve**

Søve AB  
EA Rosengrensgatan 32  
421 31 Västra Frölunda  
Phone: +46 (0)31 773 97 00  
[www.sove.se](http://www.sove.se)

## Monteringstips / Assembly Advice / Monteringsstips

N

- Les monteringsanvisningen nøye før montering.

- Monter elementene i rekkefølgen som vist.
- Boltene bør ikke skrues for hardt til før alt er montert, vatret og loddet. Skru så boltene til.
- NB! Ved bruk av drill, kan boltene ryke.
- På grunn av at solen kan gjøre rutsjeflaten veldig varm, bør rutsjebanens utløp vende mot nord-øst eller nord-vest.
- Er lekeutstyret plassert i naturlige ferdselstraséer må området sikres mot gjennomgang.
- Innspringningshinder bør vurderes rundt lekeapparater hvor det er stor bevegelse, f.eks. ved huskestativ.
- Det bør være fritt innsyn til lekeutstyr som er beregnet for barn under 3 år.

**NB! Under monteringsarbeidet må utstyr, som ikke er forankret forsvarlig i bakken, sikres slik at det ikke velte.**

**Området må avstenges under montering av apparatene med sperrebånd eller lignende.**

EN

- Read the instruction carefully before assembling the play unit.

- Assemble the components in the sequence shown in these instructions. Fixings must not be fully tightened during assembly. Before casting the foundations, the structure must be level and plumb, at which point all fixings are tightened. PS! If use of drill, the bolts may be wrecked.
- Avoid positioning the slide facing due south because of overheating – ideal positions are facing north-east or north-west. Secure the construction-area to prevent people from walking through it.
- Consider installing barriers around play-equipment which gives rise to a lot of activity – i.e. swings.
- Ensure that clear vision is possible across the play area so that supervision is possible from any position, particularly where children under 3 years of age will be playing.

**NB! During assembly of the equipment, ensure that all structures are securely propped, especially when left overnight. Also ensure that equipment is supported**

**Monteringstips / Assembly Advice / Monteringsstips****S**

- Läs monteringsanvisningen noga före montering.

- Montera delarna i den ordningen som anvisas
- Skruvarna bör inte skruvas för hårt tills allt är monterat, i våg och lodat.









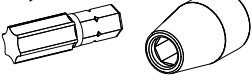

OBS! Används elektrisk skruvdragare, kan bulten gå sönder. Hårdra därför manuellt!

- Solen kan göra att rutchbanan blir väldigt varm. Banans nedfart rekommenderas att vändas i norrlig riktning
- Om lekplatsen placeras vid en gångväg mm bör området säkras mot genomfart av gående och cyklister.
- Insprängningshinder bör placeras runt lekutrustning med stor rörelse, t ex, gungställning.
- Det bör vara fri insyn till lekutrustning beräknat till barn under 3 år.

**OBS! Under monteringsarbete bör utrustningen som inte ska förankras i marken, ställs så att den inte kan välta.**

**Området måste spärras när lekutrustningen byggs upp, med avspärrningsband eller liknande.**

**Nødvendig verktøy / Tools required / Nödvändiga verktyg**

<p>(N)</p> <p>(EN)</p> <p>(S)</p>	<p>(A)</p> 	<p>(B)</p>  <p>Torx Nr 45</p> 	<p>(C)</p> <p>5 mm 6 mm</p> 	<p>(D)</p> 	<p>(E)</p> 
		<p>Metermål</p> <p>Metric measure</p> <p>Tumstock</p> 	<p>Ø11mm Bor</p> <p>Ø11mm Drill</p> <p>Ø11mm Borr</p> 	<p>Merkebånd</p> <p>Mark ribbon</p> <p>Märkeband</p> 	<p>13 + 17mm</p> 

**Nødvendig antall personer / Number of persons required / Rekommenderad antal personer**





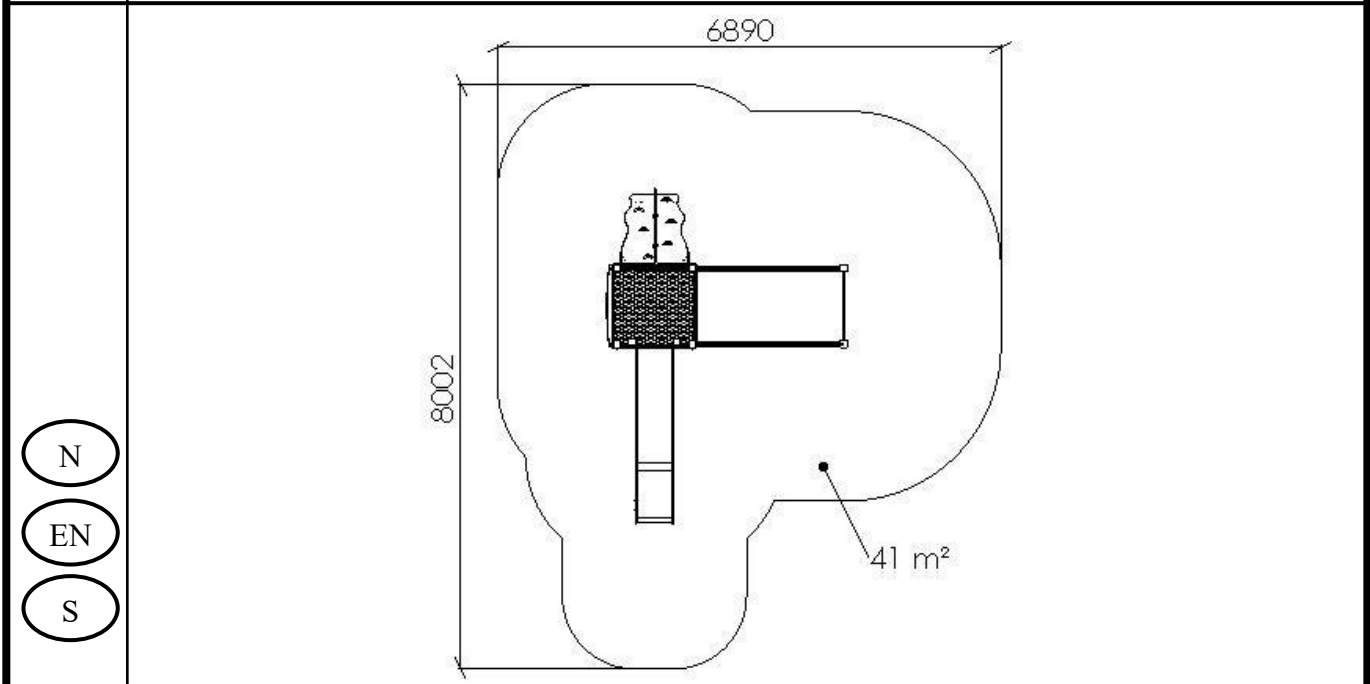





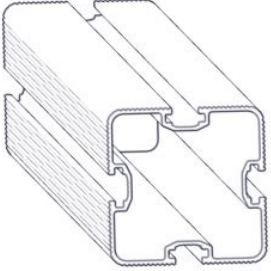

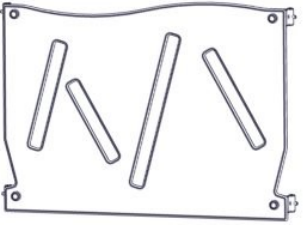
**Anbefalt arealbehov ved montering / Recommended working space / Rekommenderad arealbehov vid montering**

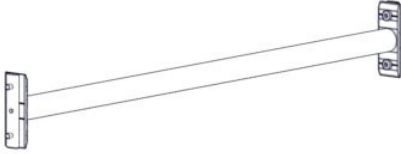

**Boltepakker for / Boltpackage for / Bultpaket för**



Sign. \_\_\_\_\_

Lunde med flagg, Trestruktur, 11-145-272	Navn	Artnr/ dimensjon	Ant	Lev
	Stolpe 95x95 Lengde = 3035 Sort Stolpe 95x95 Lengde = 4400 Sort	SFA5117/1  SFA5117/1	5  1	
	Gulv Portal-0-0-0 1160 x 1160 x 15 Grå	00-400-299K (se egen delmontering)	1	
	Sprosse standard 1130 x 145 x 15 Grå	00-400-104K (se egen delmontering)	4	
	Rekkverk 940 x 868 x 12 Trestruktur	01-125-021K (se egen delmontering)	3	
	Rekkverk butikkdisk 940 x 630 x 12 Trestruktur	01-125-015K (se egen delmontering)	1	
	Butikkdisk 1122 x 175 x 12 Grå	01-125-016K (se egen delmontering)	1	

<b>Boltepakker for / Boltpackage for / Bultpaket för</b>		Sign. _____		
<b>Lunde med flagg, Trestruktur, 11-145-272</b>	<b>Navn</b>	<b>Artnr/ dimensjon</b>	<b>Ant</b>	<b>Lev</b>
	Sperrerør rett Lengde = 940 Sort	00-400-156K (se egen delmontering)	7	
	Drager Lengde = 1980 Hull for N-nett Sort	00-400-801K (se egen delmontering)	1	
	Drager Lengde = 1980 Uten hull Sort	00-400-844K (se egen delmontering)	1	
	N-nett 1560 x 2980 Sort	05-156-003K (se egen delmontering)	1	
	Rutsjebane inkl. portal Gulvhøyde = 1.4m Grå / Trestruktur	40-142-104K (se egen delmontering)	1	
	Opptrekksplate CC1035 Grå	01-129-117K (se egen delmontering)	1	

**Boltepakker for / Boltpackage for / Bultpaket för**

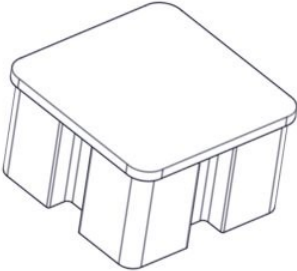
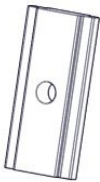
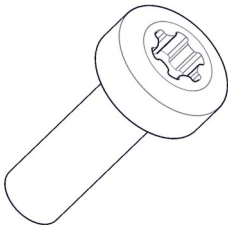
Sign. \_\_\_\_\_

Lunde med flagg, Trestruktur, 11-145-272	Navn	Artnr/ dimensjon	Ant	Lev
	Endelokk 95 x 95 stolpe Sort	00-400-998	6	
	Brikke 50x8x23 1hull	04-060-050	2	
	Torx M8x30	04-000-030	2	
	Flagg skute	02-500-067	1	
	Produktmerke	00-100-400 (montert hos Søve)	0	

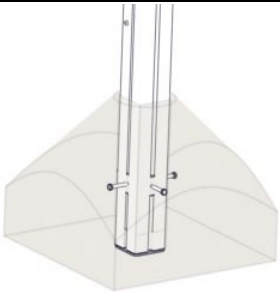
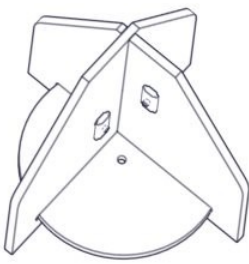
<b>Boltepakker for / Boltpackage for / Bultpaket för</b>		Sign. _____.		
Lunde med flagg, Trestruktur, 11-145-272	Navn	Artnr/ dimensjon	Ant	Lev
	<b>Fundament Støp</b>			
	Støpefundament 95 x 95 stolpe	00-003-110K (se egen delmontering)	6	
	<b>Fundament Nedgravning</b>			
	Nedgravningsfundament 95 x 95 stolpe	00-003-004K (se egen delmontering)	6	

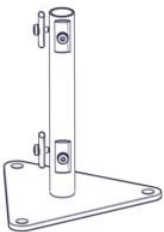
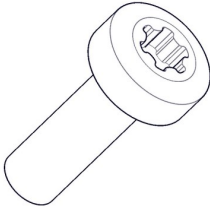

<b>Boltepakker for / Boltpackage for / Bultpaket för</b>		Sign. _____		
Lunde med flagg, Trestruktur, 11-145-272	Navn	Artnr/ dimensjon	Ant	Lev
	<b>Overflate fundamentering</b>			
	Fundament 95x95 stolpe for betongdekke	00-003-125K (Se egen delmontering)	6	
	<b>Deler som må Endres, Changed parts</b>			
	Opptreksplate forankring	01-129-117K	(2)	
	Rutsjebane forankring	40-142-103K	(2)	
	Stolpene kappes	SFA5117/1	(6)	
	Bruk kortere bolter når du monterer den nederste delen av veggene	04-000-016	4	

**Fundamentering med betong // Foundation concrete // Förankring med betong**

- (N) Komprimert masse Ref NS-EN 1176-1
- (EN) Compressed mass §4.2.8.5
- (S) Komprimerad massa



- (N) Bakkenivå
- (EN) Ground level
- (S) marknivå

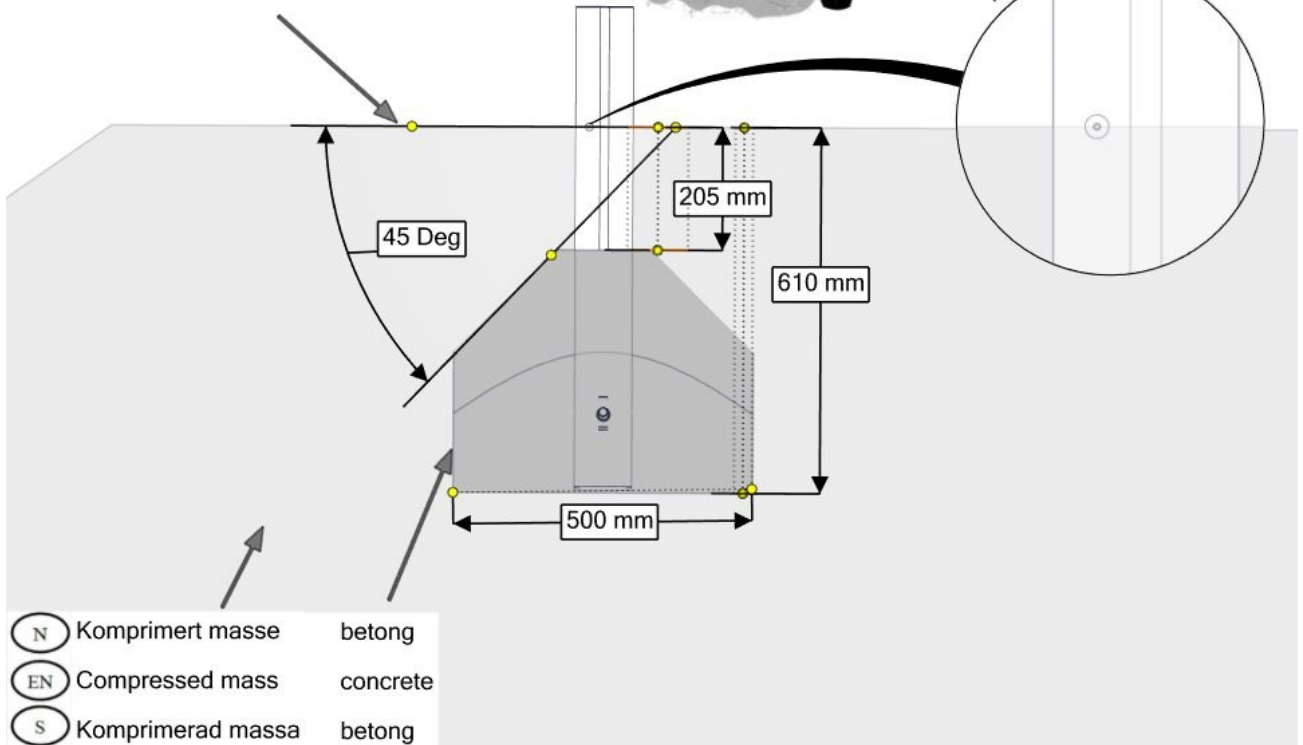

- (N) Komprimert masse betong
- (EN) Compressed mass concrete
- (S) Komprimerad massa betong

**Fundamentering uten betong // Foundation without concrete // Förankring utan betong**

- (N) Støtdempende materialer Ref NS-EN 1176-1
- (EN) Impact attenuating materials §4.2.8.5
- (S) Støtdämpande material

- (N) Bakkenivå
- (EN) Ground level
- (S) Marknivå

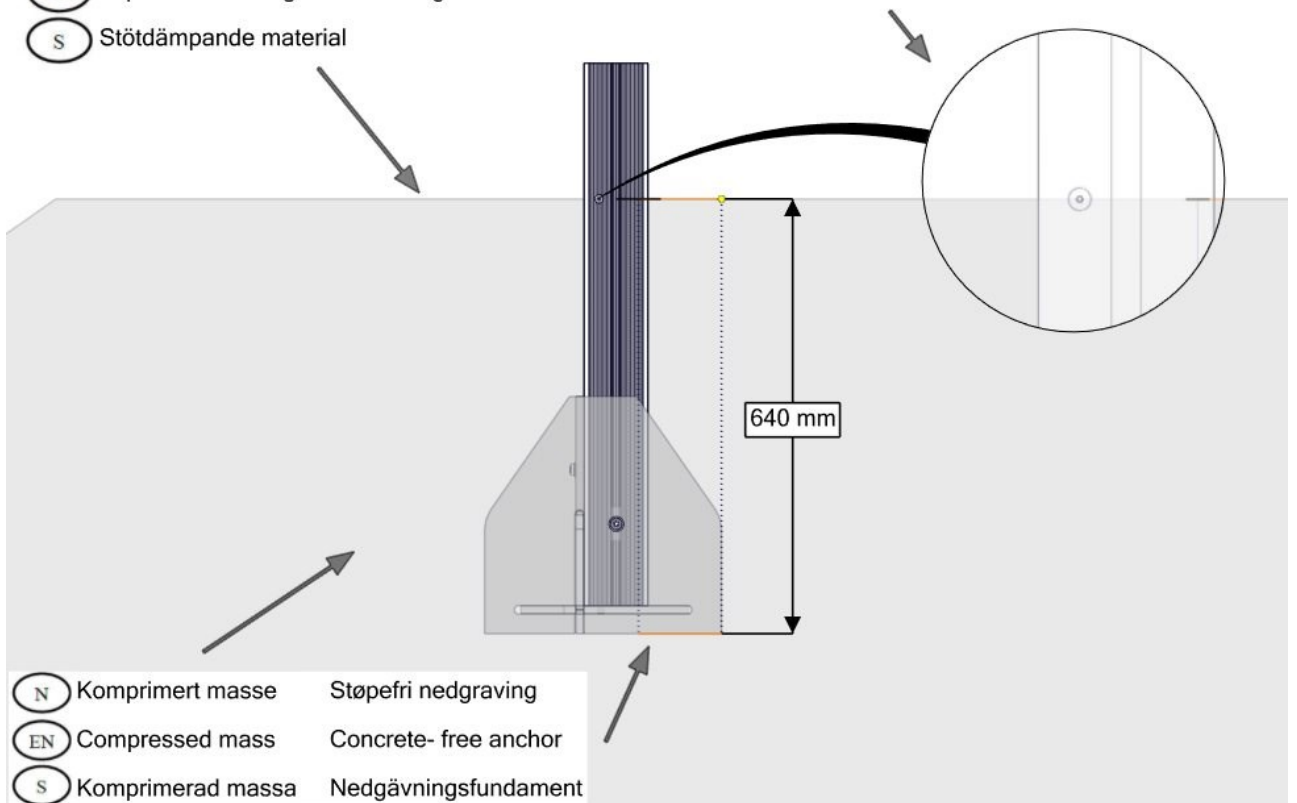

- (N) Komprimert masse Støpefri nedgraving
- (EN) Compressed mass Concrete-free anchor
- (S) Komprimerad massa Nedgävningsfundament

**Overflatemontering, Surface mounting, Ytmontering**

Ref  
NS-EN 1176-1  
§4.2.8.5

(N) (EN) (S)  
Bakkenivå Ground level marknivå

Tykkelse/Thickness

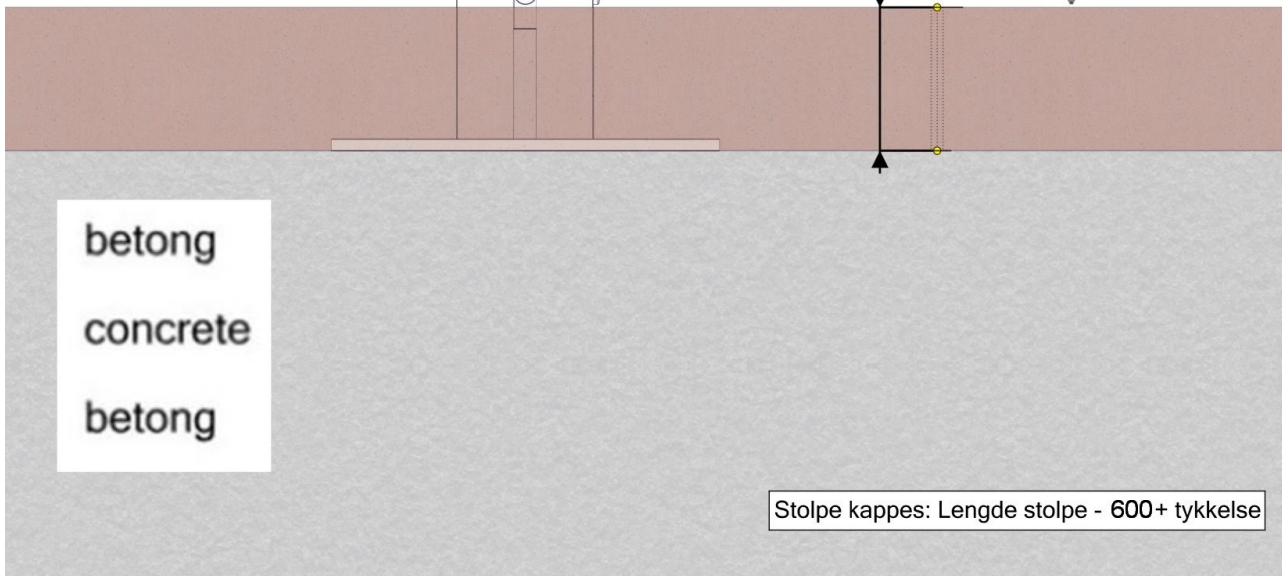

betong  
concrete  
betong

Stolpe kappes: Lengde stolpe - 600+ tykkelse

Når du har overfalte monteringsfundamenter bruk korte skurer på nedeste festepunkter.

If you are using 0-level anchors use short bolt for mounting lower lower parts

04-000-016

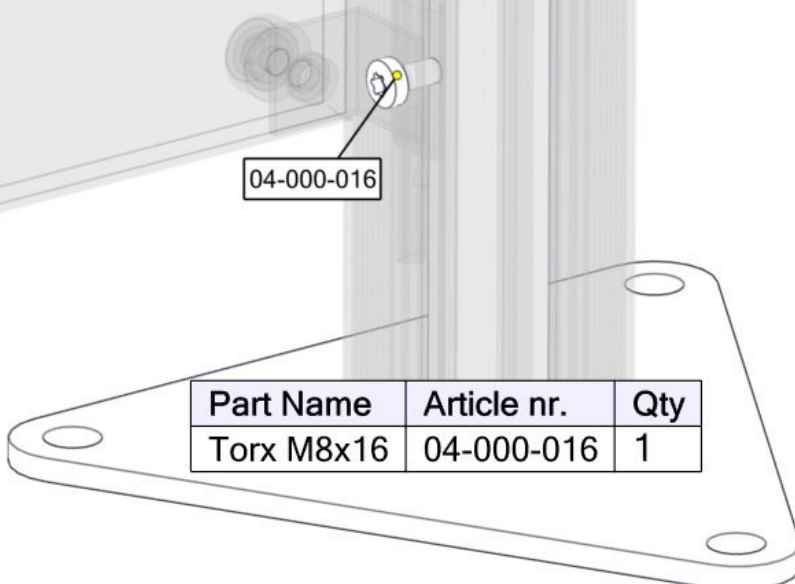

Part Name	Article nr.	Qty
Torx M8x16	04-000-016	1

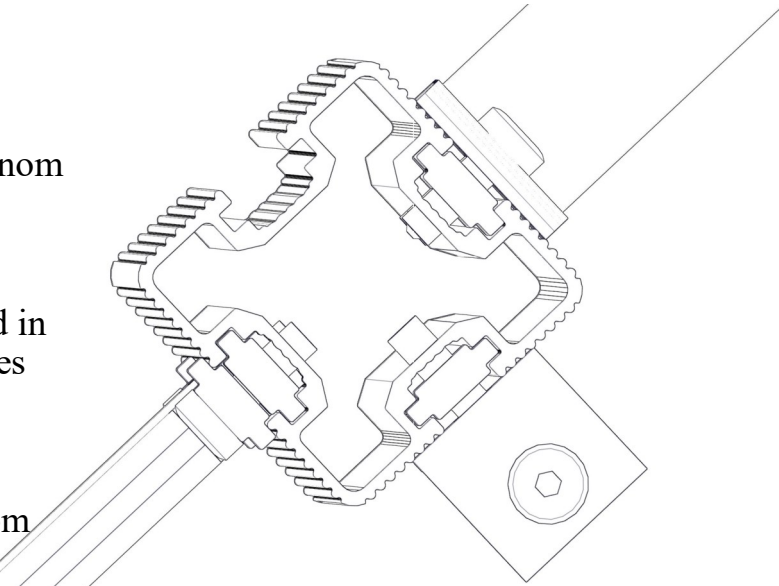
<p>(N) Bolten skrues HELT igjennom aluminiumen. Maks moment: 30Nm</p> <p>(EN) The bolt must be tightened in to the post, so that it peirces the aluminium Max torque: 30Nm</p> <p>(S) Bulten skuvas HELT genom aluminiumen. Maks vridmoment: 30Nm</p>					
NO		Betongkvalitet			
SE		Betongkvalitet	C25/30		
EN		Concrete quality			
NO		Mengde betong			
SE		Mängd betong		0,6	m <sup>3</sup>
EN		Amount of concrete			
NO		Fundament størrelse			
SE		Stiftelsestorlek		0,5 x 0,5 x 0,4	m
EN		Foundation size			
NO		For sikkerhet må fundamentene med sand eller myk jord være minst 50% større i areal			
SE		För säkerheten måste grunden med sand eller mjuk jord vara minst 50% större i området			
EN		For safety, the foundations with sand or soft soil must be at least 50% larger in area			
NO		Tyngste element			
SE		Tyngsta element	40-142-104	49,1	Kg
EN		Heaviest element			
NO		Største element			
SE		Största element	40-142-104	3,01x0,52x0,35	m
EN		Biggest element			

**Fallhøyder / Free height of fall / Fallhöjder**

Fallhøyde = 2,4 m

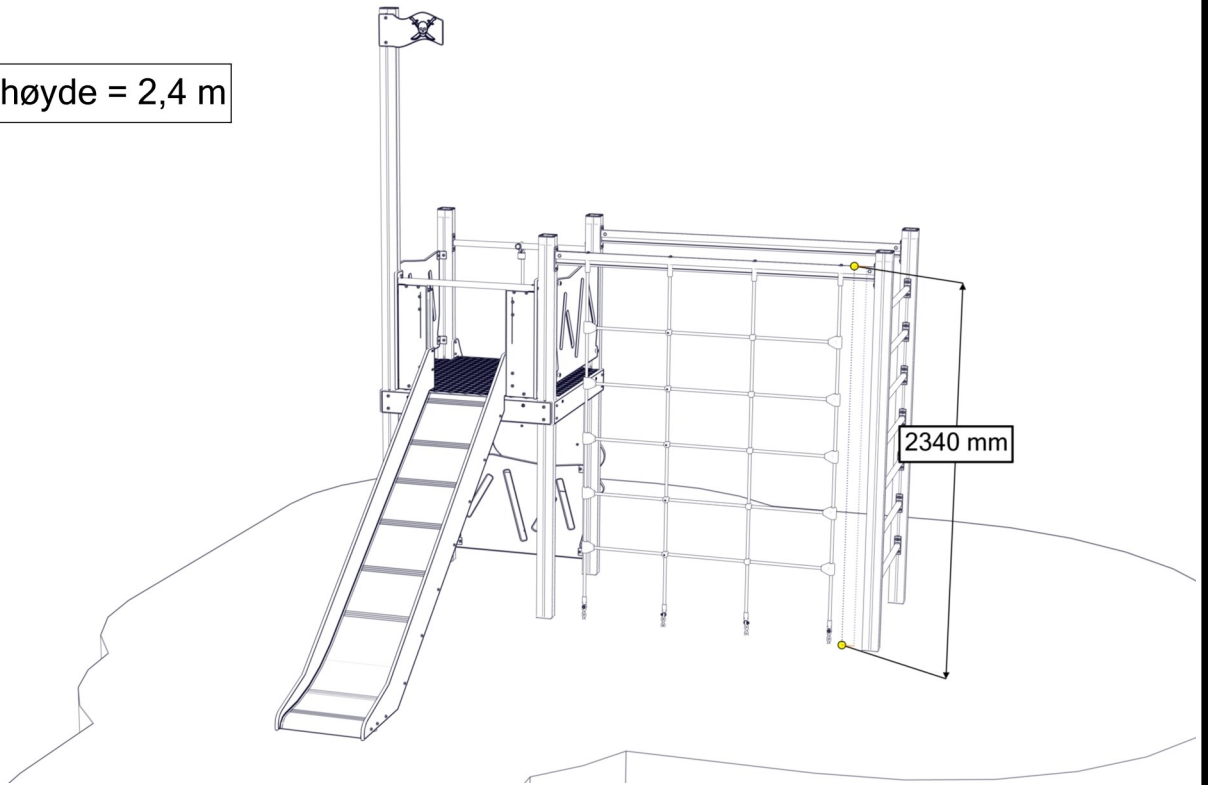

**Sikkerhetszone / Safety zone / Säkerhetszon**

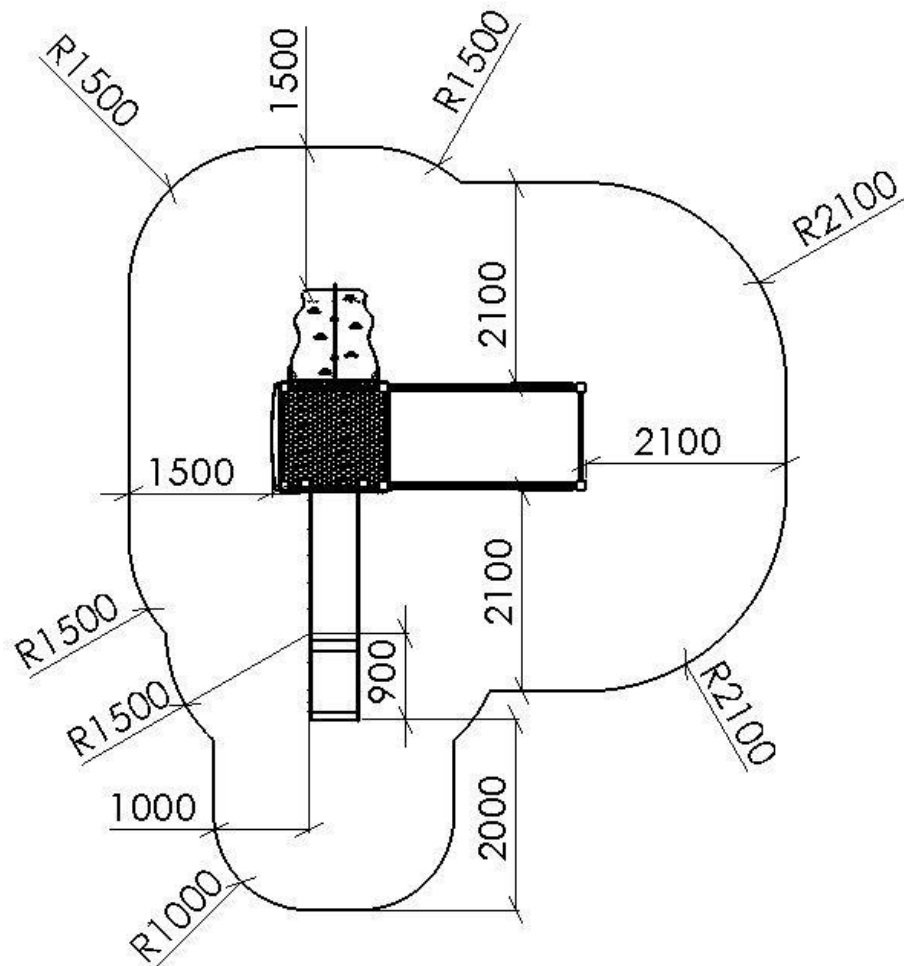

### Plassering av forankringer / Ground plan / Placering av förankringar

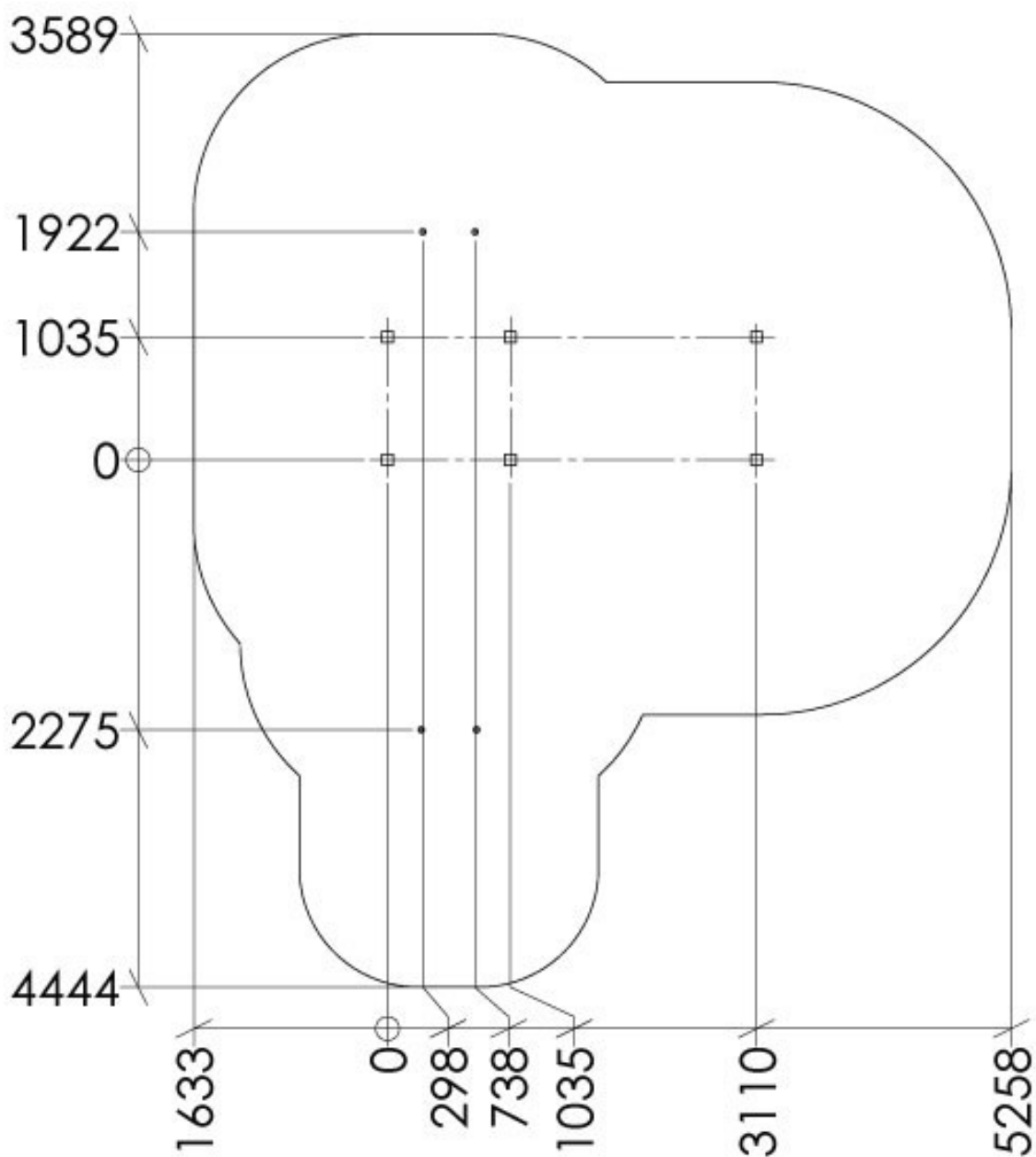

N

Alle mål er oppgitt i millimeter

EN

Scale measured in mm

S

Alla mått är i millimeter.

# Montering av lekeapparatet / Assembly instructions / Montering av lekredskapet

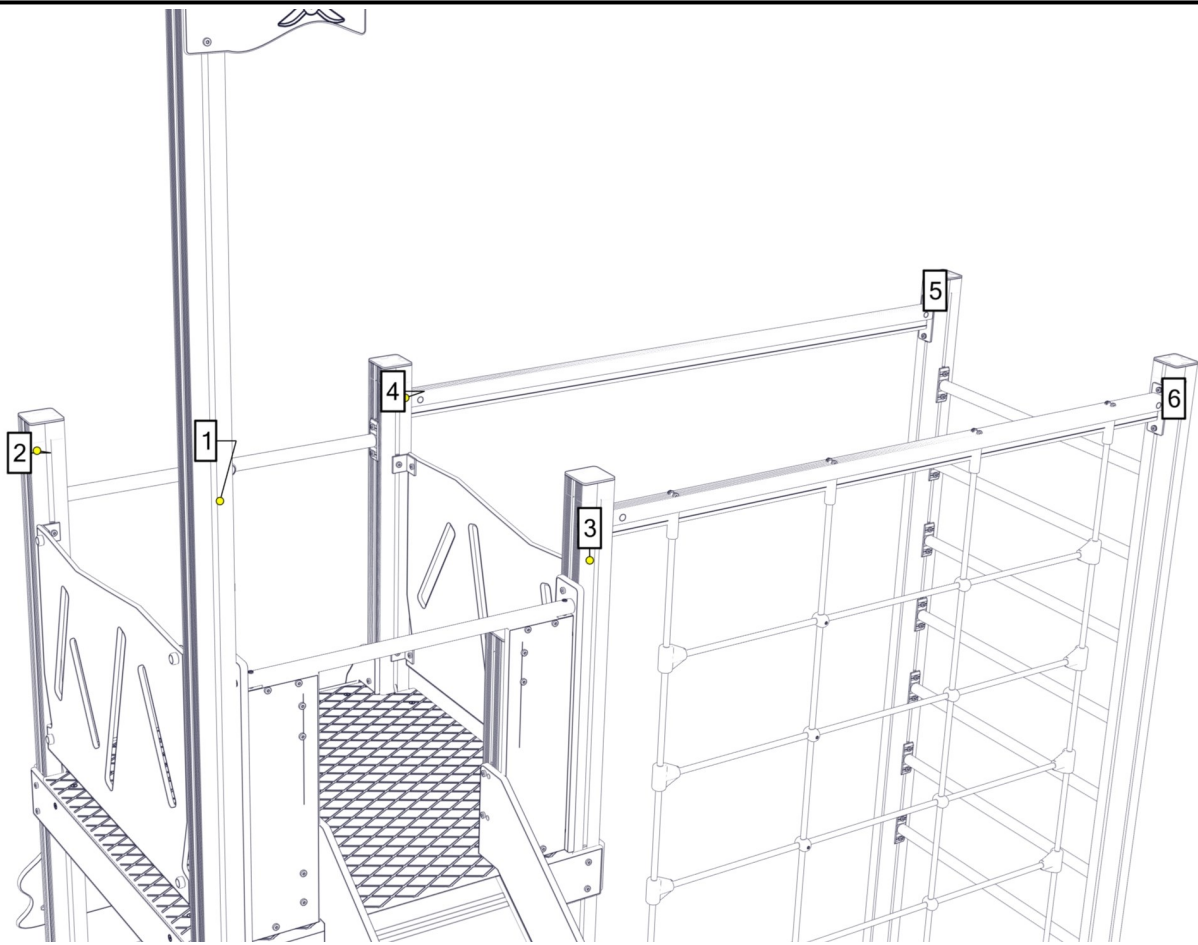

Se separat delmontering for detaljer  
 See separate assembly for details  
 Se separata delmontering för detaljer

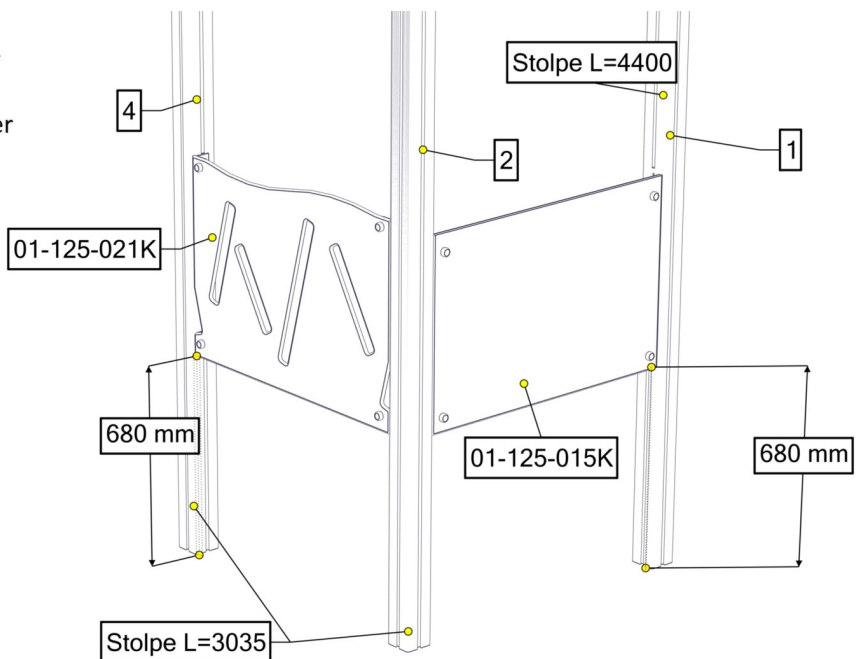

PartName	Artnr	Antall
Rekkverk 940x868x12	01-125-021K	1
Rekkverk butikdisk 940x630x12	01-125-015K	1
Stolpe 95x95 L=3035	SFA5117/1	2
Stolpe 95x95 L=4400	SFA5117/2	1

## Montering av lekeapparatet / Assembly instructions / Montering av lekredskapet

Se separat delmontering for detaljer  
 See separate assembly for details  
 Se separata delmontering för detaljer

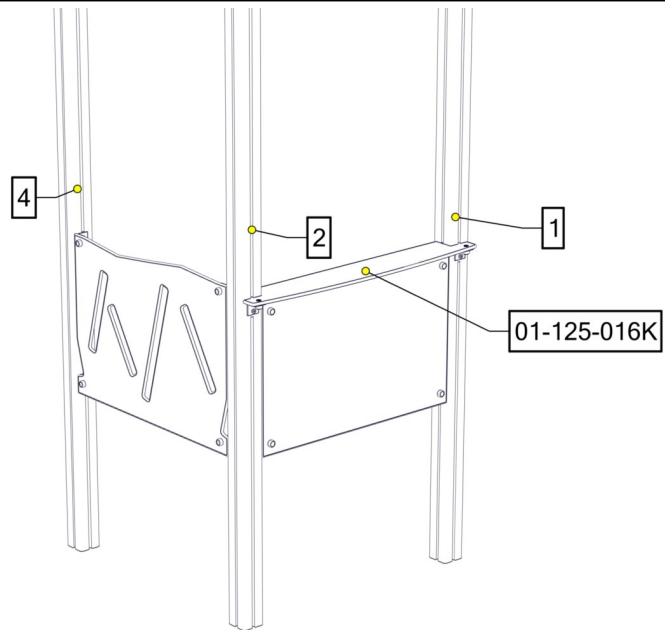

PartName	Artnr	Antall
Butikkdisk 1122 x 175 x 12	01-125-016K	1

Se separat delmontering for detaljer  
 See separate assembly for details  
 Se separata delmontering för detaljer

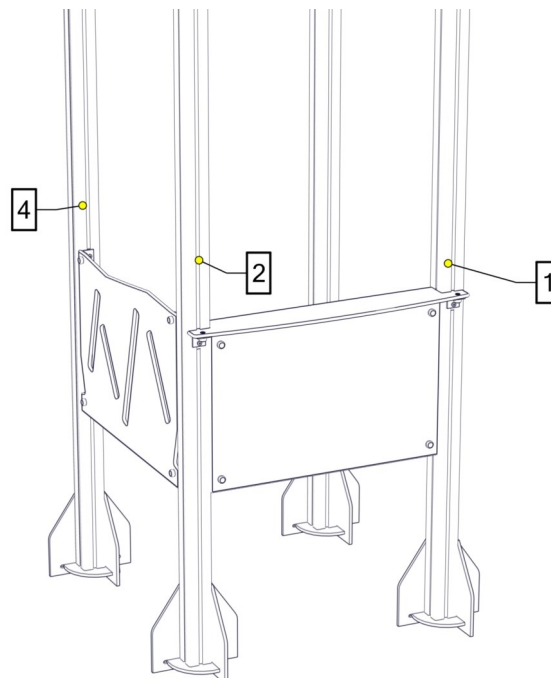

PartName	Artnr	Antall
Nedgravingsfundament 95x95	00-003-004K	4
Stolpe 95x95 L=3035	SFA5117/1	1



## Montering av lekeapparatet / Assembly instructions / Montering av lekredskapet

Se separat delmontering for detaljer  
 See separate assembly for details  
 Se separata delmontering för detaljer

Brikke 150 3xM8

Montert hos Søve  
 Assembled at Søve  
 Monterad hos Søve

00-400-104K

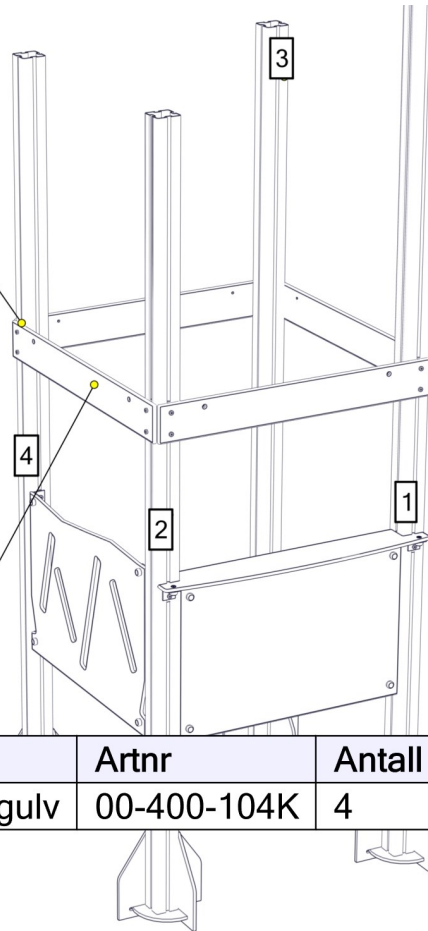

PartName	Artnr	Antall
Sprosse std 1130x145x15 for gulv	00-400-104K	4

Se separat delmontering for detaljer  
 See separate assembly for details  
 Se separata delmontering för detaljer

00-400-299K

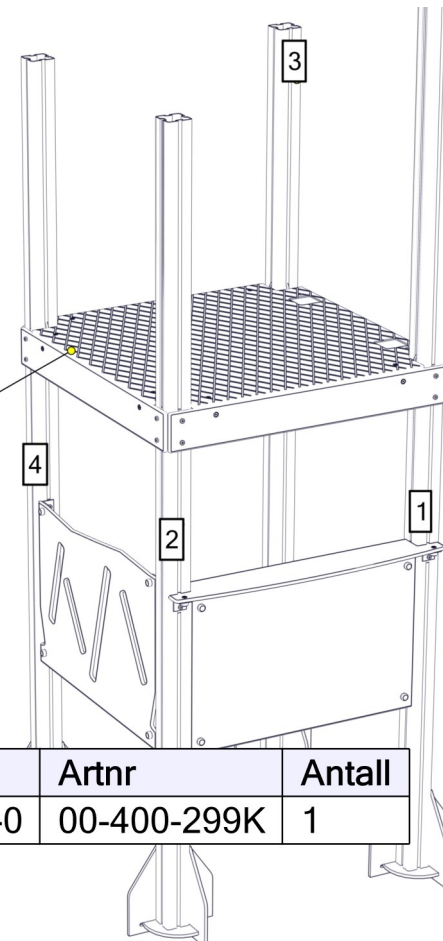

PartName	Artnr	Antall
Gulv 1160x1160x15 P-0-0-0	00-400-299K	1

**Montering av lekeapparatet / Assembly instructions / Montering av lekredskapet**

Se separat delmontering for detaljer  
 See separate assembly for details  
 Se separata delmontering för detaljer

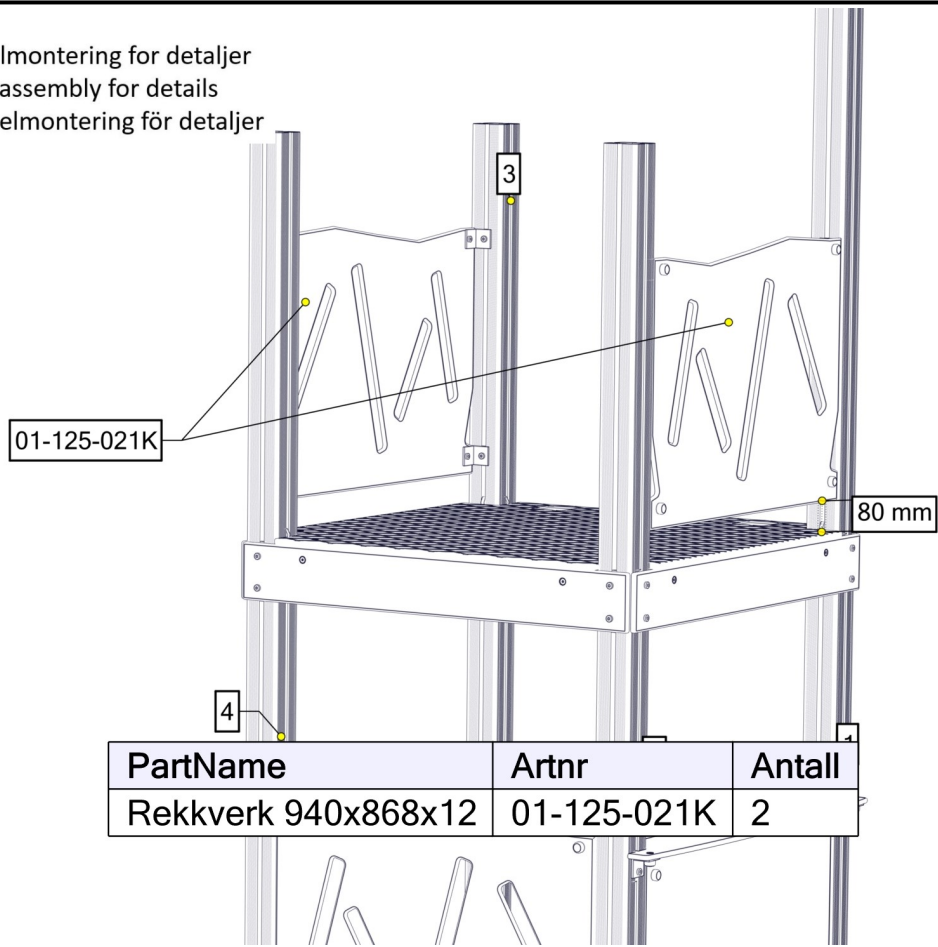

Se separat delmontering for detaljer  
 See separate assembly for details  
 Se separata delmontering för detaljer

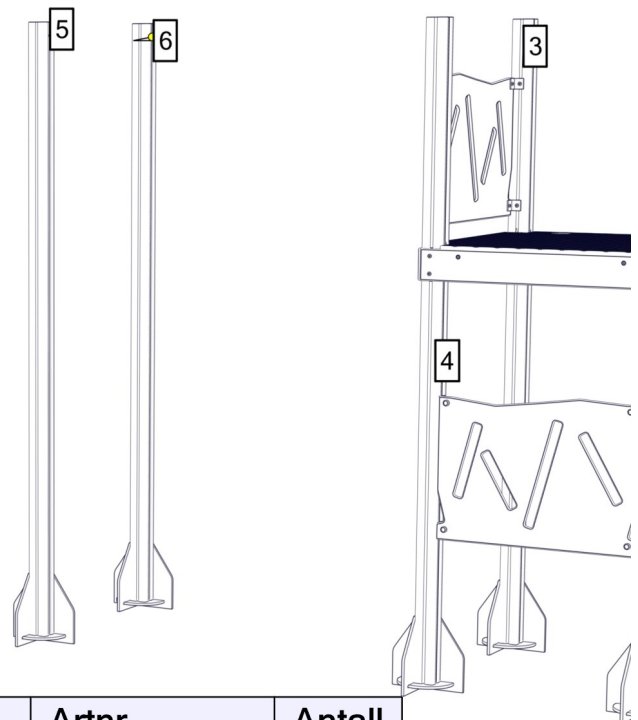

PartName	Artnr	Antall
Nedgravingsfundament 95x95	00-003-004K	2
Stolpe 95x95 L=3035	SFA5117/1	2

**Montering av lekeapparatet / Assembly instructions / Montering av lekredskapet**

Se separat delmontering for detaljer  
See separate assembly for details  
Se separata delmontering för detaljer

PartName	Artnr	Antall
Sperrerør L=940	00-400-156K	7

Se separat delmontering for detaljer  
See separate assembly for details  
Se separata delmontering för detaljer

PartName	Artnr	Antall
Alu profil Type I, N-Nett L=1980	00-400-801K	1
Alu profil Type I, uten oppheng L=1980	00-400-844K	1

## Montering av lekeapparatet / Assembly instructions / Montering av lekredskapet

Se separat delmontering for detaljer  
 See separate assembly for details  
 Se separata delmontering för detaljer

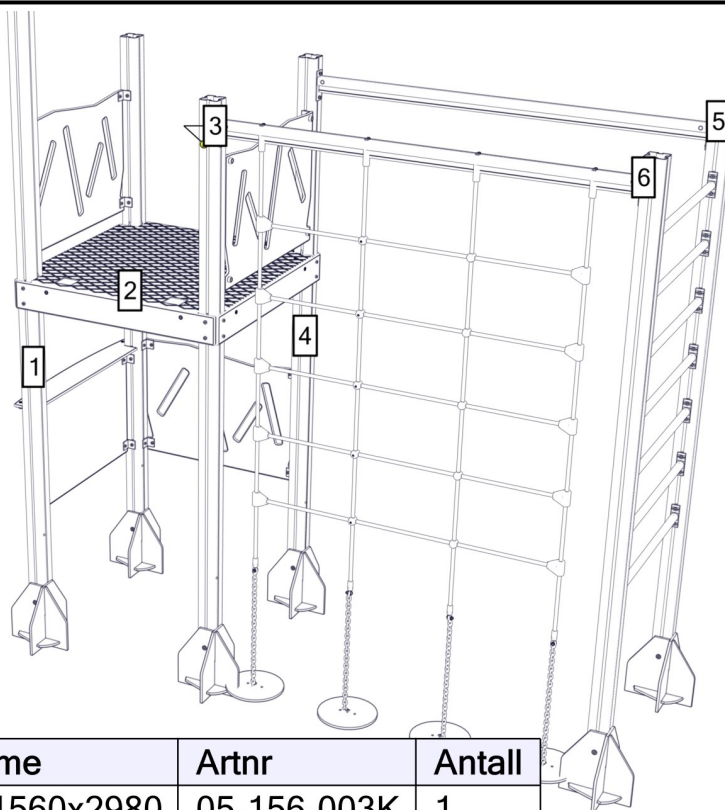

PartName	Artnr	Antall
N-nett 1560x2980	05-156-003K	1

Se separat delmontering for detaljer  
 See separate assembly for details  
 Se separata delmontering för detaljer

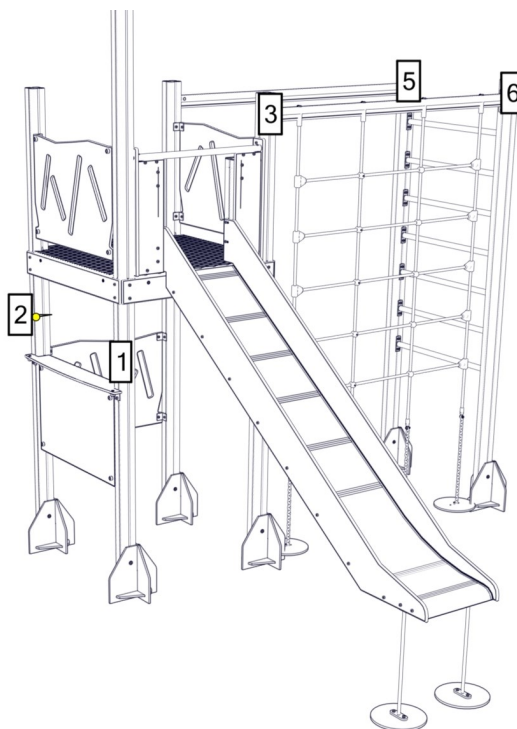

PartName	Artnr	Antall
Rustjebane H=1,4M inkl. portal	40-142-104K	1

## Montering av lekeapparatet / Assembly instructions / Montering av lekredskapet

Se separat delmontering for detaljer  
 See separate assembly for details  
 Se separata delmontering för detaljer

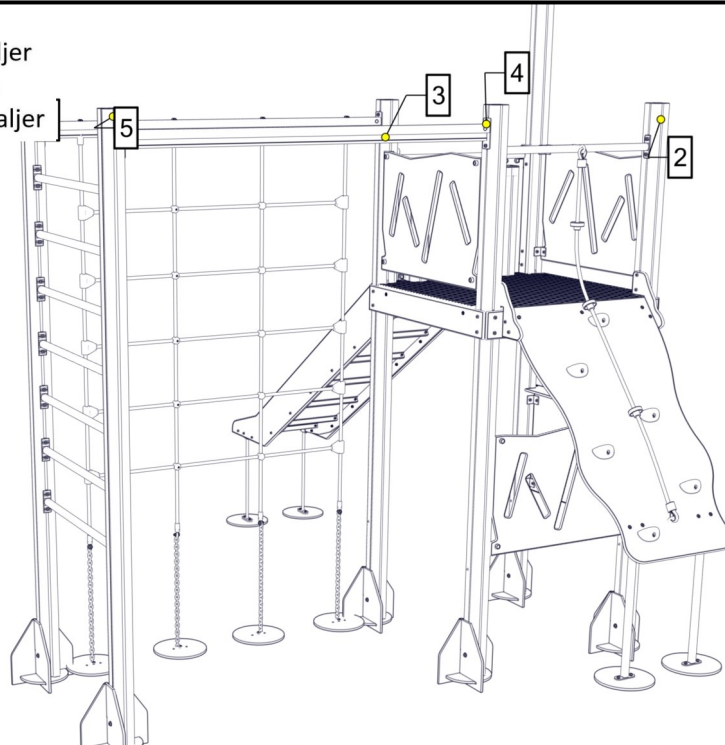

PartName	Artnr	Antall
Opptreksplate CC1035	01-129-117K	1

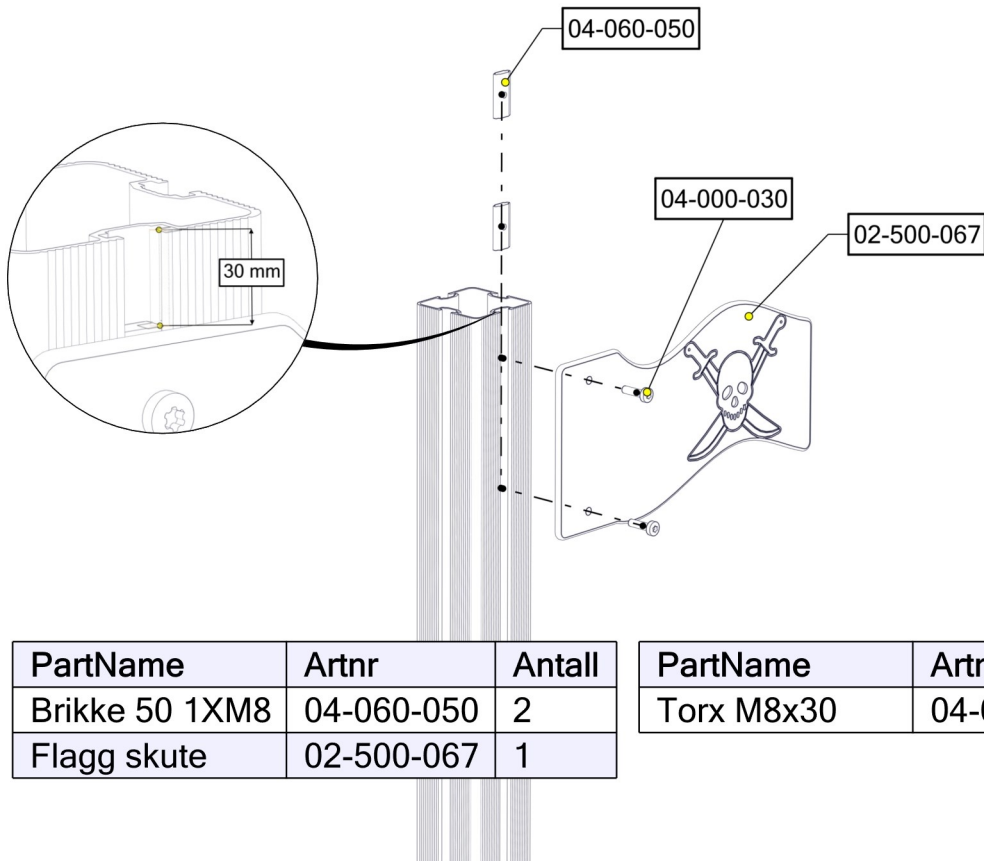

PartName	Artnr	Antall
Brikke 50 1XM8	04-060-050	2
Flagg skute	02-500-067	1

PartName	Artnr	Antall
Torx M8x30	04-000-030	2

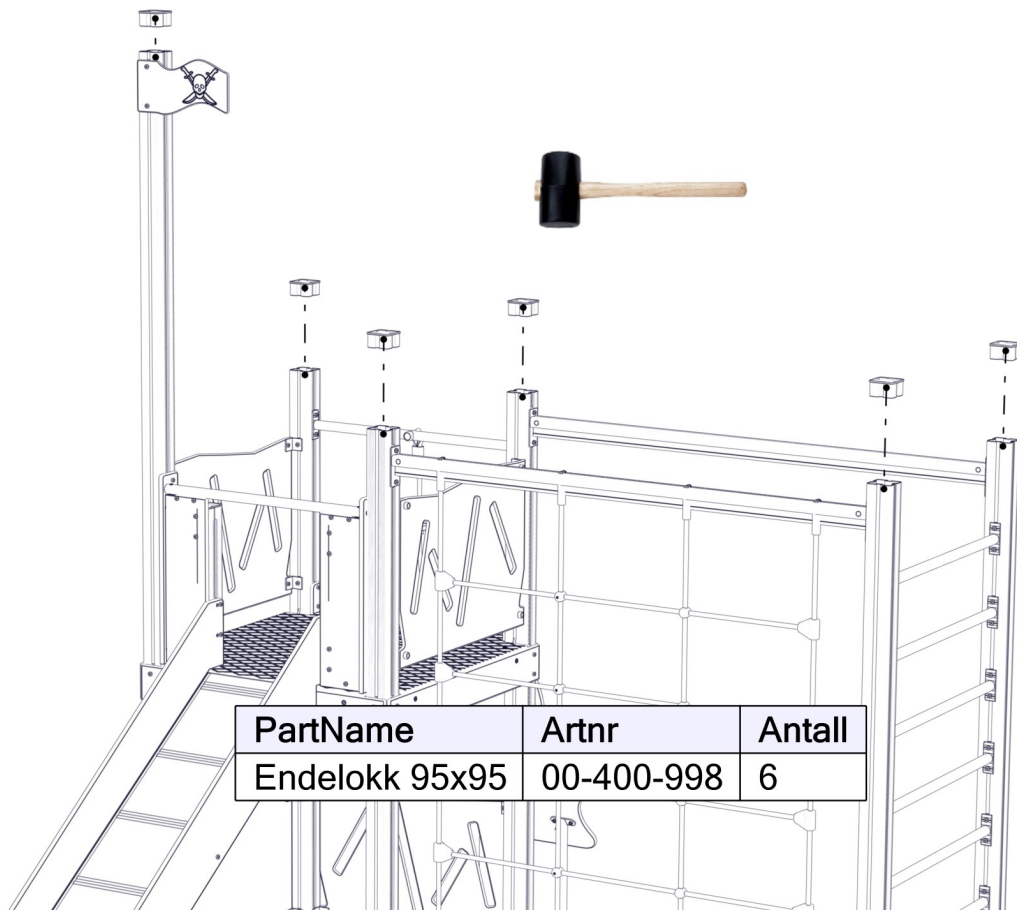



**Montering av lekeapparatet / Assembly instructions / Montering av lekredskapet**





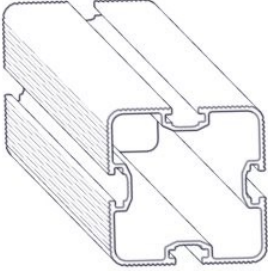

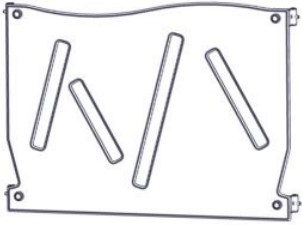
PartName	Artnr	Antall
Endelokk 95x95	00-400-998	6

<b>Før utstyret tas i bruk / Before play begins / Innan lekredskapet tas i bruk</b>	
<b>N</b>	<ul style="list-style-type: none"> <li>● Påse at fallunderlag er utlagt i henhold til gjeldende regler eller vår anbefaling</li> <li>● Fjern alle monteringshjelpemidler ( rester av betong, planker, paller, plast, og lignende)</li> <li>● Før utstyret tas i bruk, burde man sjekke at det ikke er fare for at anorakksnorer og lignende som kan hekte seg fast noen steder på lekeapparatet. (Vedlagte snor med dobbe (kneledd) kan brukes til å sjekke at dette er i orden. Se vedlagte veiledning for bruk av denne. Dette gjøres for å oppdage eventuelle feilmonteringer.?)</li> <li>● NB! Bør stå i 2-3 dager før bruk</li> </ul>
<b>EN</b>	<ul style="list-style-type: none"> <li>● Make sure the area and depth of safer surfacing are according to the current standard, or to the manufacturer's recommendation</li> <li>● Make sure all tools and surplus materials are removed before play begins</li> <li>● PS! When complete, allow 2-3 days for the concrete to set before use</li> </ul>
<b>S</b>	<ul style="list-style-type: none"> <li>● Kontrollera att fallunderlag är utlagt enligt gällande regler eller vårt rekommendation</li> <li>● Ta bort alla monteringshjälpmedel (rester av betong, plankor, pallar, plast och liknande)</li> <li>● Innan lekredskapet används, kontrollera att anoracksnoddar eller kläder/delar av kläder eller liknande inte kan fastna i några delar på redskapet. (Den bipackade "knävringen" kan man med fördel användas för denna kontroll.</li> <li>● Detta görs för att upptäcka eventuella felmonteringar.)</li> </ul>

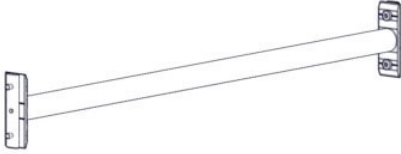





<b>Boltepakker for / Boltpackage for / Bultpaket för</b>		Sign. _____		
<b>Lunde med flagg, Trestruktur, 11-145-272</b>	<b>Navn</b>	<b>Artnr/ dimensjon</b>	<b>Ant</b>	<b>Lev</b>
	Stolpe 95x95 Lengde = 3035 Sort	SFA5117/1	5	
	Stolpe 95x95 Lengde = 4400 Sort	SFA5117/1	1	
	Gulv Portal-0-0-0 1160 x 1160 x 15 Grå	00-400-299K (se egen delmontering)	1	
	Sprosse standard 1130 x 145 x 15 Grå	00-400-104K (se egen delmontering)	4	
	Rekkverk 940 x 868 x 12 Trestruktur	01-125-021K (se egen delmontering)	3	
	Rekkverk butikkdisk 940 x 630 x 12 Trestruktur	01-125-015K (se egen delmontering)	1	
	Butikkdisk 1122 x 175 x 12 Grå	01-125-016K (se egen delmontering)	1	

<b>Boltepakker for / Boltpackage for / Bultpaket för</b>		Sign. _____.		
<b>Lunde med flagg, Trestruktur, 11-145-272</b>	<b>Navn</b>	<b>Artnr/ dimensjon</b>	<b>Ant</b>	<b>Lev</b>
	Sperrerør rett Lengde = 940 Sort	00-400-156K (se egen delmontering)	7	
	Drager Lengde = 1980 Hull for N-nett Sort	00-400-801K (se egen delmontering)	1	
	Drager Lengde = 1980 Uten hull Sort	00-400-844K (se egen delmontering)	1	
	N-nett 1560 x 2980 Sort	05-156-003K (se egen delmontering)	1	
	Rutsjebane inkl. portal Gulvhøyde = 1.4m Grå / Trestruktur	40-142-104K (se egen delmontering)	1	
	Opptrekksplate CC1035 Grå	01-129-117K (se egen delmontering)	1	

**Boltepakker for / Boltpackage for / Bultpaket för**

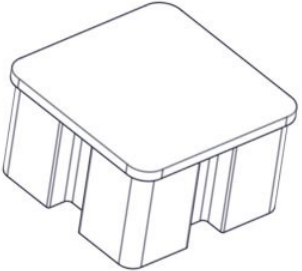
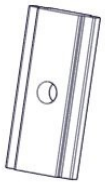
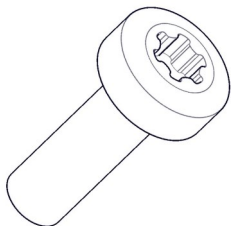
Sign. \_\_\_\_\_

Lunde med flagg, Trestruktur, 11-145-272	Navn	Artnr/ dimensjon	Ant	Lev
	Endelokk 95 x 95 stolpe Sort	00-400-998	6	
	Brikke 50x8x23 1hull	04-060-050	2	
	Torx M8x30	04-000-030	2	
	Flagg skute	02-500-067	1	
	Produktmerke	00-100-400 (montert hos Søve)	0	

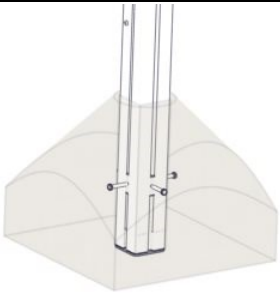
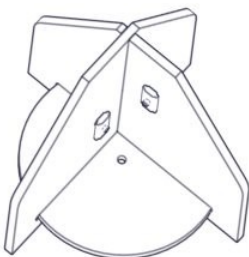
<b>Boltepakker for / Boltpackage for / Bultpaket för</b>		Sign. _____		
Lunde med flagg, Trestruktur, 11-145-272	Navn	Artnr/ dimensjon	Ant	Lev
	<b>Fundament Støp</b>			
	Støpefundament 95 x 95 stolpe	00-003-110K (se egen delmontering)	6	
	<b>Fundament Nedgravning</b>			
	Nedgravningsfundament 95 x 95 stolpe	00-003-004K (se egen delmontering)	6	

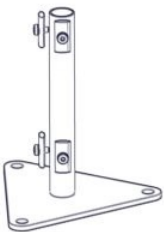
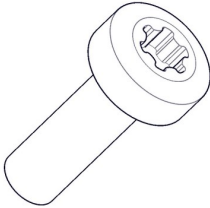
<b>Boltepakker for / Boltpackage for / Bultpaket för</b>		Sign. _____.		
Lunde med flagg, Trestruktur, 11-145-272	Navn	Artnr/ dimensjon	Ant	Lev
	<b>Overflate fundamentering</b>			
	Fundament 95x95 stolpe for betongdekke	00-003-125K (Se egen delmontering)	6	
	<b>Deler som må Endres, Changed parts</b>			
	Opptreksplate forankring	01-129-117K	(2)	
	Rutsjebane forankring	40-142-103K	(2)	
	Stolpene kappes	SFA5117/1	(6)	
	Bruk kortere bolter når du monterer den nederste delen av veggene	04-000-016	4	