

N**Monteringsanvisning****EN****Assembly Instructions****S****Monteringsanvisning**

Produkt nr. / Product no. / Produkt nr.

11-275-100

Ord. nr. _____

Dato. _____

Sign. _____

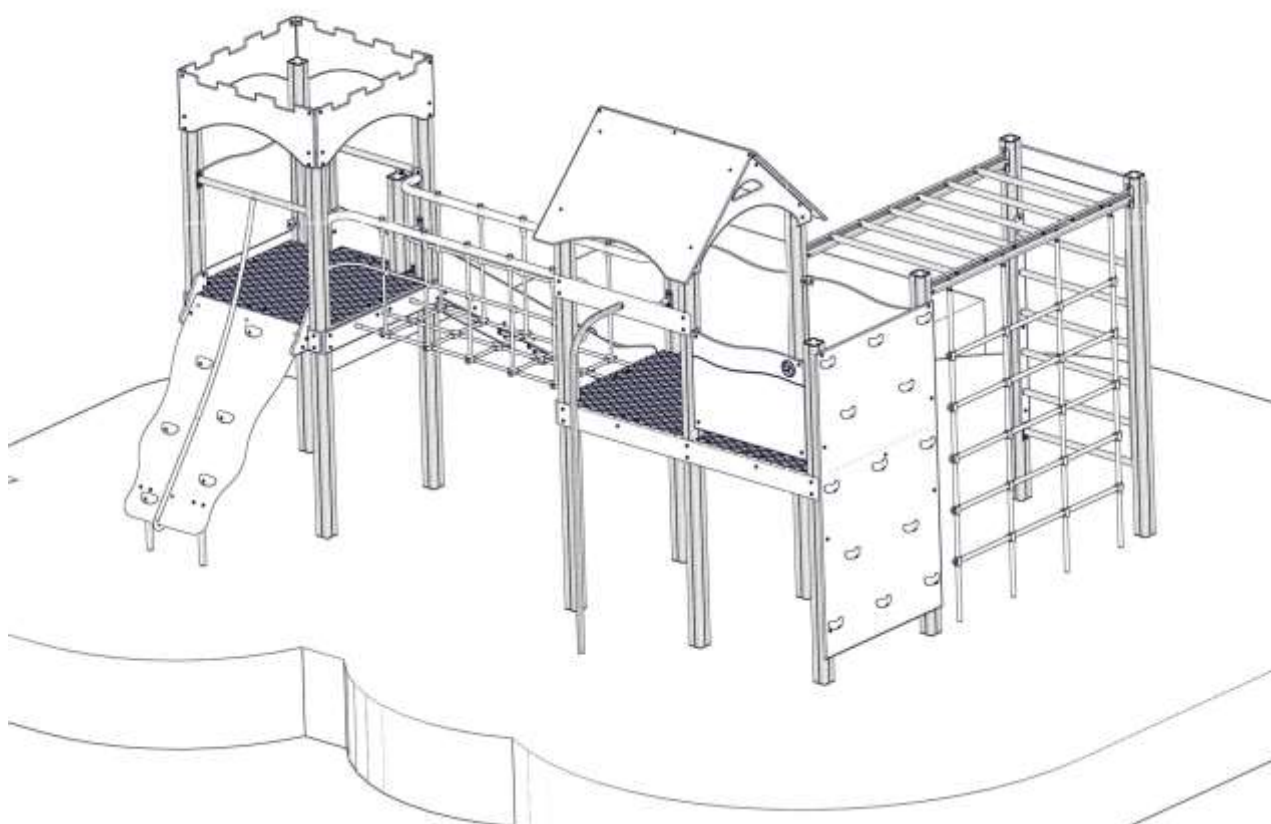

Søve AS
Grønnvoldveien 290
3830 Ulefoss - Norway
Tlf: +47 35 94 65 65



Søve AB
EA Rosengrensgatan 32
421 31 Västra Frölunda
Phone: +46 (0)31 773 97 00
www.sove.se

Monteringstips / Assembly Advice / Monteringsstips

N

- Les monteringsanvisningen nøye før montering.
- Monter elementene i rekkefølgen som vist.
- Boltene bør ikke skrues for hardt til før alt er montert, vatret og loddet. Skru så boltene til.
- NB! Ved bruk av drill, kan boltene ryke.
- På grunn av at solen kan gjøre rutsjeplaten veldig varm, bør rutsjebanens utløp vende mot nord-øst eller nord-vest.
- Er lekeutstyret plassert i naturlige ferdselstraséer må området sikres mot gjennomgang.
- Innspringningshinder bør vurderes rundt lekeapparater hvor det er stor bevegelse, f.eks. ved huskestativ.
- Det bør være fritt innsyn til lekeutstyr som er beregnet for barn under 3 år.

NB! Under monteringsarbeidet må utstyr, som ikke er forankret forsvarlig i bakken, sikres slik at det ikke velte.

Området må avstenges under montering av apparatene med sperrebånd eller lignende.

EN

- Read the instruction carefully before assembling the play unit..
- Assemble the components in the sequence shown in these instructions.
- Fixings must not be fully tightened during assembly. Before casting the foundations, the structure must be level and plumb, at which point all fixings are tightened.
- PS! If use of drill, the bolts may be wrecked.
- Avoid positioning the slide facing due south because of overheating – ideal positions are facing north-east or north-west.
- Secure the construction-area to prevent people from walking through it.
- Consider installing barriers around play-equipment which gives rise to a lot of activity – i.e.swings.
- Ensure that clear vision is possible across the play area so that supervision is possible from any position, particularly where children under 3 years of age will be playing.

NB! During assembly of the equipment, ensure that all structures are securely propped, especially when left overnight. Also ensure that equipment is supported whilst concrete foundations are setting and enclose the area securely to prevent access.

Monteringstips / Assembly Advice / Monteringsstips

S

- Läs monteringsanvisningen noga före montering.
- Montera delarna i den ordningen som anvisas
- Skruvarna bör inte skruvas för hårt tills allt är monterat, i våg och lodat.











OBS! Används elektrisk skruvdragare, kan bulten gå sönder. Hårdra därför manuellt!

- Solen kan göra att rutchbanan blir väldigt varm. Banans nedfart rekommenderas att vändas i norrlig riktning
- Om lekplatsen placeras vid en gångväg mm bör området säkras mot genomfart av gående och cyklister.
- Inspjängningshinder bör placeras runt lekutrustning med stor rörelse, t ex, gungställning.
- Det bör vara fri insyn till lekutrustning beräknat till barn under 3 år.

OBS! Under monteringsarbete bör utrustningen som inte ska förankras i marken, ställs så att den inte kan välta.

Området måste spärras när lekutrustningen byggs upp, med avspärrningsband eller liknande.

Nødvendig verktøy / Tools required / Nödvändiga verktyg

<p>(N)</p> <p>(EN)</p> <p>(S)</p>	<p>(A)</p> 	<p>(B)</p>  <p>Torx Nr 45 High quality</p>	<p>(C)</p> <p>5 mm 6 mm</p> 	<p>(D)</p> 	<p>(E)</p> 
		<p>Metermål Metric measure Tumstock</p> 	<p>16 V</p> 	<p>Merkeband Mark ribbon Märkeband</p> 	<p>13 + 17mm</p> 

Nødvendig antall personer / Number of persons required / Rekommenderad antal personer





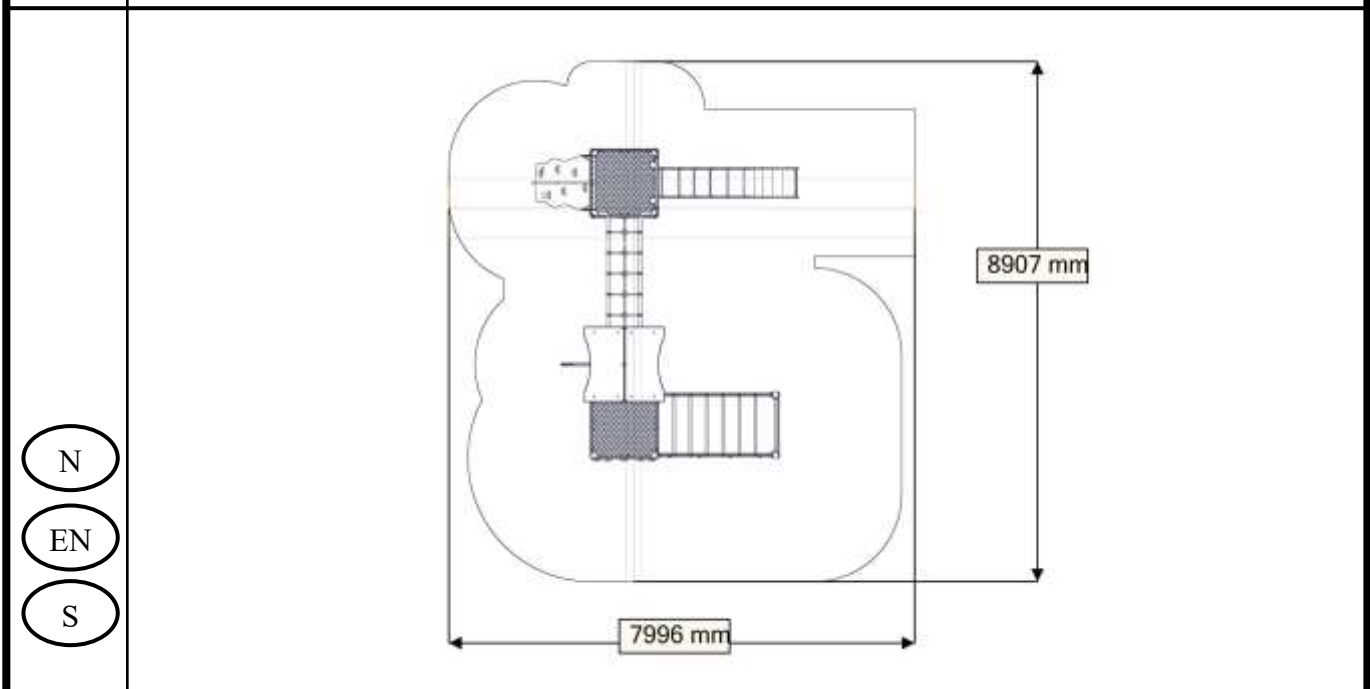











Anbefalt arealbehov ved montering / Recommended working space / Rekommenderad arealbehov vid montering













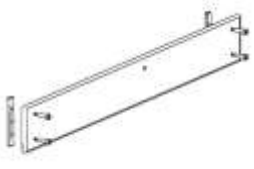

Boltepakker for / Boltpackage for / Bultpaket för

Sign. _____

Stolpe 95x95	Ant= 1	Navn	Artnr/dimensjon	Ant	Lev
		VK95 L=2900 600-2300 (1) VK95 L=3035 600-2435(1) VK95 L=3235 600-2635(8)	00-400-010 00-400-053 00-400-009	1 1 8	
		Stolp ende (1)	00-400-998	10	
Portal 01-400-220	Ant= 1	Navn	Artnr/dimensjon	Ant	Lev
		Frontplate (1)	01-126-003	2	
		Side plate H (1) Side plate V (1)	01-126-001 01-126-002	1 1	
		Sperrerør (1)	01-126-004	1	
		Stolpe VK95 (2) L=640	01-126-005	2	
		Stolpende (2)	00-400-998	2	
		Torx M8x16 (6) Torx M8x35 (16) Torx M8x45 (82)	04-000-016 04-000-035 04-000-045	6 16 2	
		Brikke 120 3T (8)	04-060-120	8	
		Vinkel (2) 35x35x3 11mm hull	04-070-036	2	
		Møbelknapp (6) M8-13-17	04-030-011	6	
		Hylesmutter (2) M8 12-38	04-018-060	2	
		Skive M8 (4)	04-050-008	4	



















Boltepakker for / Boltpackage for / Bultpaket för

Sign. _____

Sprosse ribbevegg	Ant= 1	Navn	Artnr/dimensjon	Ant	Lev
		Sprosse (1) 1160x145x15	01-400-108	1	
		Torx M8x35 (4)	04-000-035	4	
		Brikke 150_3T (2)	04-000-150	2	
Ribbevegg	Ant= 1	Navn	Artnr/dimensjon	Ant	Lev
		Stolpe med HPL 600-2435 = 3035	00-400-016	1	
		Stolpe med HPL 600-2435 = 3035	00-400-017	1	
		Torx M8x25 (4)	04-000-025	4	
		Brikke 120_3T (2)	04-060-120	2	
		Sperrørør med be- slag L=940	00-400-150	1	
		Ribbevegg rør L=940	00-400-149	5	
		Stolp ende (1)	00-400-998	2	















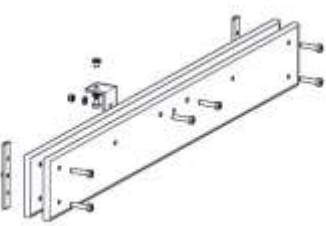

Boltepakker for / Boltpackage for / Bultpaket för

Sign. _____

Gulv 1160x1160x15	Ant= 1	Navn	Artnr/dimensjon	Ant	Lev
		Gulv (1)	00-400-300	1	
		Vinkel 50x50x4(2)	04-070-050	2	
		Torx M8x30 (2) Torx M8x12(2)	04-000-030 04-000-012	2 2	
		Møbelknapp (2)	04-030-011	2	
		Plast plug 9-11 mm (16)	04-090-002	16	
		Plug spor (8)	00-400-980	8	
		Skive M8 (4)	04-050-008	4	
		Låsemutter M8	04-040-008	2	
Gulv 2195x1160x15 For klattrevegg	Ant= 1	Navn	Artnr/dimensjon	Ant	Lev
		Gulv (1)	00-400-351_CUT	1	
		Vinkel 50x50x4(4)	04-070-050	4	
		Torx M8x30 (4) Torx M8x12(4)	04-000-030 04-000-012	4 4	
		Møbelknapp (4)	04-030-011	4	
		Plast plug 9-11 mm (24)	04-090-002	24	
		Plug spor (14)	00-400-980	14	
		Skive M8 (4)	04-050-008	8	
		Låsemutter M8	04-040-008	4	











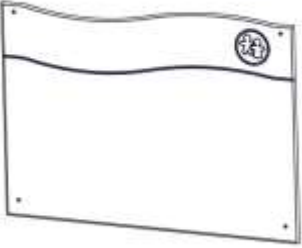
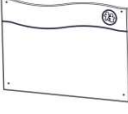

Boltepakker for / Boltpackage for / Bultpaket för

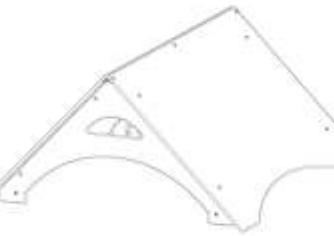
Sign. _____

Sprosse 01-400-108	Ant= 5	Navn	Artnr/dimensjon	Ant	Lev
		Sprosse (1) 1160x145x15	01-400-108	5	
		Torx M8x35 (4)	04-000-035	20	
		Brikke 150_3T (2) På stolpe	04-060-150	0	
Sprosse 01-400-112 med hull polyfixnett	Ant= 2	Navn	Artnr/dimensjon	Ant	Lev
		Sprosse (2) 1160x145x15 Med hull	01-400-112	4	
		Torx M8x50 (4) Torx M8x45(2) Torx M8x12 (1)	04-000-050 04-000-045 04-000-012	8 4 2	
		Brikke 150_3T (2) På stolpe	04-060-150	0	
		Møbelknapp (1) M8- 13-17	04-030-011	2	
		Vinkel 50x50x4(1) 11mm hull	04-070-050	2	
		Mutter M8 (1)	04-040-008	2	
		Skive M8 (2)	04-050-008	4	
Sprosse 01-400-108	Ant= 2	Navn	Artnr/dimensjon	Ant	Lev
		Sprosse (1) 2165x145x15	01-400-203	2	
		Torx M8x35 (6)	04-000-035	12	
		Brikke 150_3T (3) På stolpe	04-060-150	0	











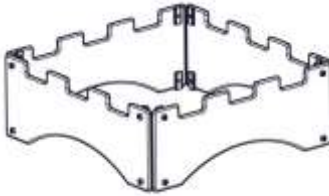
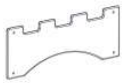

Boltepakker for / Boltpackage for / Bultpaket för

Sign. _____

Vegg 940x686x12 01-125-002	Ant= 4	Navn	Artnr/dimensjon	Ant	Lev
		Vegg 940x686x12 (1)	01-125-002	4	
		Brikke 50_1T(4)	04-060-050	16	
		Torx M8x25(8)	04-000-025	32	
		Vinkel 50x50x50x4 (4)	04-070-050	16	
		Mutter M8(4)	04-040-008	16	
Tak 01-128-000	Ant= 1	Navn	Artnr/dimensjon	Ant	Lev
		Tak 1280x960x12 (2)	01-128-001	2	
		Gavel 1216x668x12 (2)	01-128-002	2	
		Brikke 50_1T (4)	04-060-050	4	
		Torx M8x12(22) Torx M8x35(4)	04-000-012 04-000-035	22 4	
		Vinkel 35x35x35x3 (11)	04-070-036	11	
		Møbelknapp M8_13_17(22)	04-030-011	22	
		Skive M8 822)	04-050-008	22	











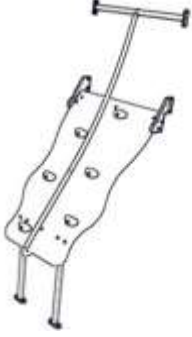



Boltepakker for / Boltpackage for / Bultpaket för

Sign. _____

Tak borg 01-400-501	Ant= 1	Navn	Artnr/dimensjon	Ant	Lev
		Tak 2230x400x12 (4)	01-400-502	4	
		Brikke 120_3T (8)	04-060-120	8	
		Torx M8x25(24)	04-000-025	24	
		Vinkel 50x50x50x4 (9)	04-075-050	4	
		Låsemutter M8	04-030-011	8	
Brannstang	Ant= 1	Navn	Artnr/dimensjon	Ant	Lev
		Sprosse (1) 1160x145x15	01-400-108	1	
		Torx M8x35 (4) Torx M8x45(1)	04-000-035 04-000-045	6 1	
		Brikke 150_3T (2)	04-060-150	2	
		Brannrør 81)	00-400-180	1	
		Hylsemutter M8x40	04-018-060	1	
		Skive M8 stor Skive M8	04-055-008 04-050-008	1 2	
		Fundament	00-003-106	1	
		Låsemutter	04-040-008	2	

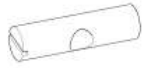









Boltepakker for / Boltpackage for / Bultpaket för

Sign. _____

Opptreksplate 01-129-112	Ant= 1	Navn	Artnr/dimensjon	Ant	Lev
		Opptreksplate (1)	01-129-112	1	
		Brikke120 3T(5)	04-060-120	4	
		Torx M8x45(2) Torx M8x40(3) Torx M8x35(4) Torx M8x30(10) Torx M8x25(5)	04-000-045 04-000-040 04-000-035 04-000-030 04-000-025	2 3 8 10 5	
		Skive M8(2)	04-050-008	14	
		Mutter M8(2)	04-040-008	14	
		Stålforankring(2)	01-129-114	2	
		U-profil (1)	02-500-086	1	
		Feste HPL (2)	01-129-113	2	
		Møbelknapp (3)	04-030-016	3	
		Hylsemutter (2)	04-018-060	2	
		Vinkel 35x35x35x3 (2)	04-070-035	2	
		Sperrerør med kjetting L=2440	00-261-500	1	
		Fundament plate	00-003-106	2	



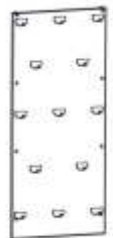
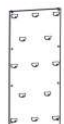











Boltepakker for / Boltpackage for / Bultpaket för

Sign. _____

Rutsjebane 1400 40-142-101	Ant= 1	Navn	Artnr/dimensjon	Ant	Lev
		Systembane 1400	40-142-101	1	
		Brikke120 3T(5)	04-060-120	2	
		Torx M8x35(4)	04-000-035	4	
		Torx M8x45(2)	04-000-045	2	
		Torzx M8x30(4)	04-000-030	4	
		Fundamentskive(2) 2H 80	00-003-106	2	
		Skive M8(2)	04-050-008	4	
		Mutter M8(2)	04-040-008	6	
		Stålforankering(2)	00-100-310	2	
	Plast plug 9-11 mm (4)	04-090-002	4		
Klatrevegg	Ant= 1	Navn	Artnr/dimensjon	Ant	Lev
		Klatrevegg	00-400-720	1	
		Torx M8x35 (8)	04-000-035	8	
		Brikke 50_1T (8)	04-000-050	8	

















Boltepakker for / Boltpackage for / Bultpaket för

Sign. _____

Ribbe tak	Ant= 1	Navn	Artnr/dimensjon	Ant	Lev
		SFA 5104 L=1980 SFA 5104 med hull N-Nett L=1980	00-400-810 00-400-809	1 1	
		Ribbe L=1026(6)	07-150-062	6	
		Torx M8x45 (12) Torx M8x25 (8)	04-000-045 04-000-025	12 8	
		Brikke 160_2T (4)	04-060-160	4	
		Hylsemutter (12)	04-018-060	12	
N-nett 05-156-003	Ant= 1	Navn	Artnr/dimensjon	Ant	Lev
		N- nett (1)	05-156-003	1	
		Torx M8x35(4) Torx M8x20(4)	04-000-035 04-000-020	4 4	
		Fundamentskive(4) 2H 80	00-003-106	4	
		Skive M8(12)	04-050-008	12	
		Mutter M8(12)	04-040-008	12	
		Sekskant M8x50	04-008-050	4	
		Koblingbolt	04-088-005	4	





Boltepakker for / Boltpackage for / Bultpaket för

Sign. _____

Poly-rett brua	Ant= 1	Navn	Artnr/dimensjon	Ant	Lev
       		Rør (2)	07-200-027	2	
		Nett brua	07-500-043	1	
		Torx M8x25 (8) Torx M8x30 (8)	04-000-025 04-000-030	8 8	
		Brikke 120_3T (8)	04-060-120	8	
		Plast Rondel (10)	05-300-036	10	
		Plast rondell (20)	05-300-036	20	
		Skive M10 stor polyfix (20)	04-055-036	20	
		Mutter M10 (10) Mutter M8 (6)	04-040-0010 04-040-008	10 6	
		Skive M8	04-055-008	6	

Boltepakker for / Boltpackage for / Bultpaket för

Sign. _____

Fundament	Ant= 12	Navn	Artnr/dimensjon	Ant	Lev
		Fundament plate(1)	00-003-010	12	
		Fundamentdel1 (1) 4x med VK70 hull 1x med VK95 hull	00-003-010	12	
		Fundament del2 (1) 4x med VK70 hull 1x med VK95 hull	00-003-010	12	
		Torx M8x35(3)	04-000-035	36	
		Brikke 120 3T (1) Brikke 501T(1)	04-060-120 04-060-120	12 12	

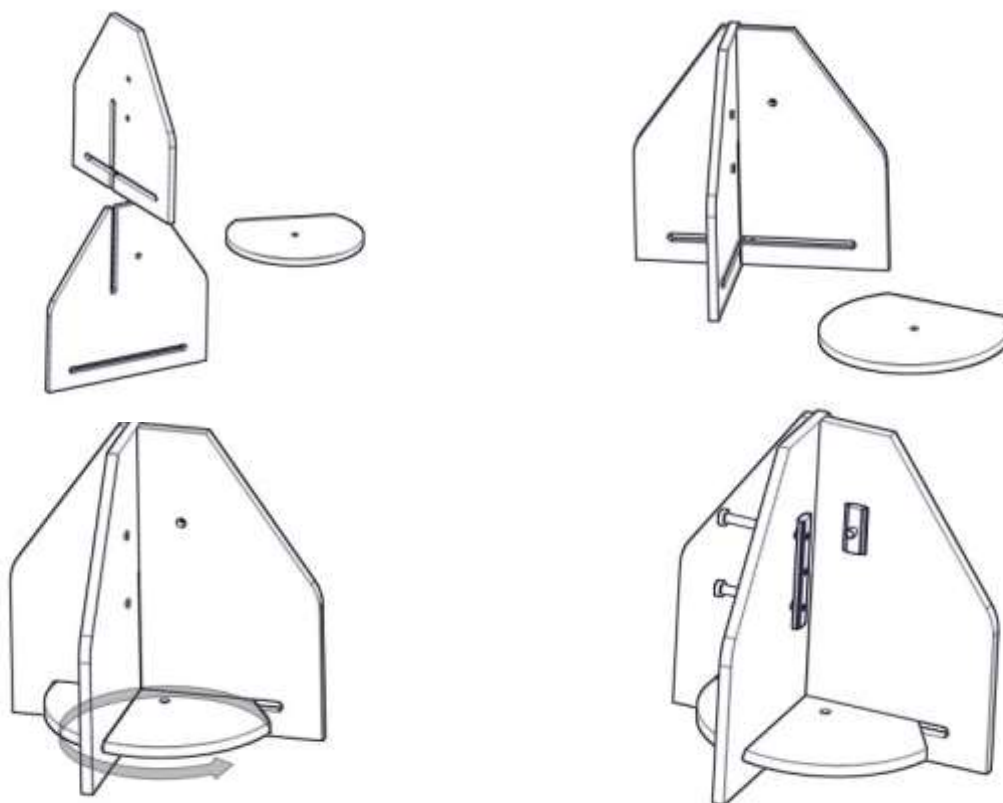

Fundamentering med betong / Foundation concrete / Förankring med betong

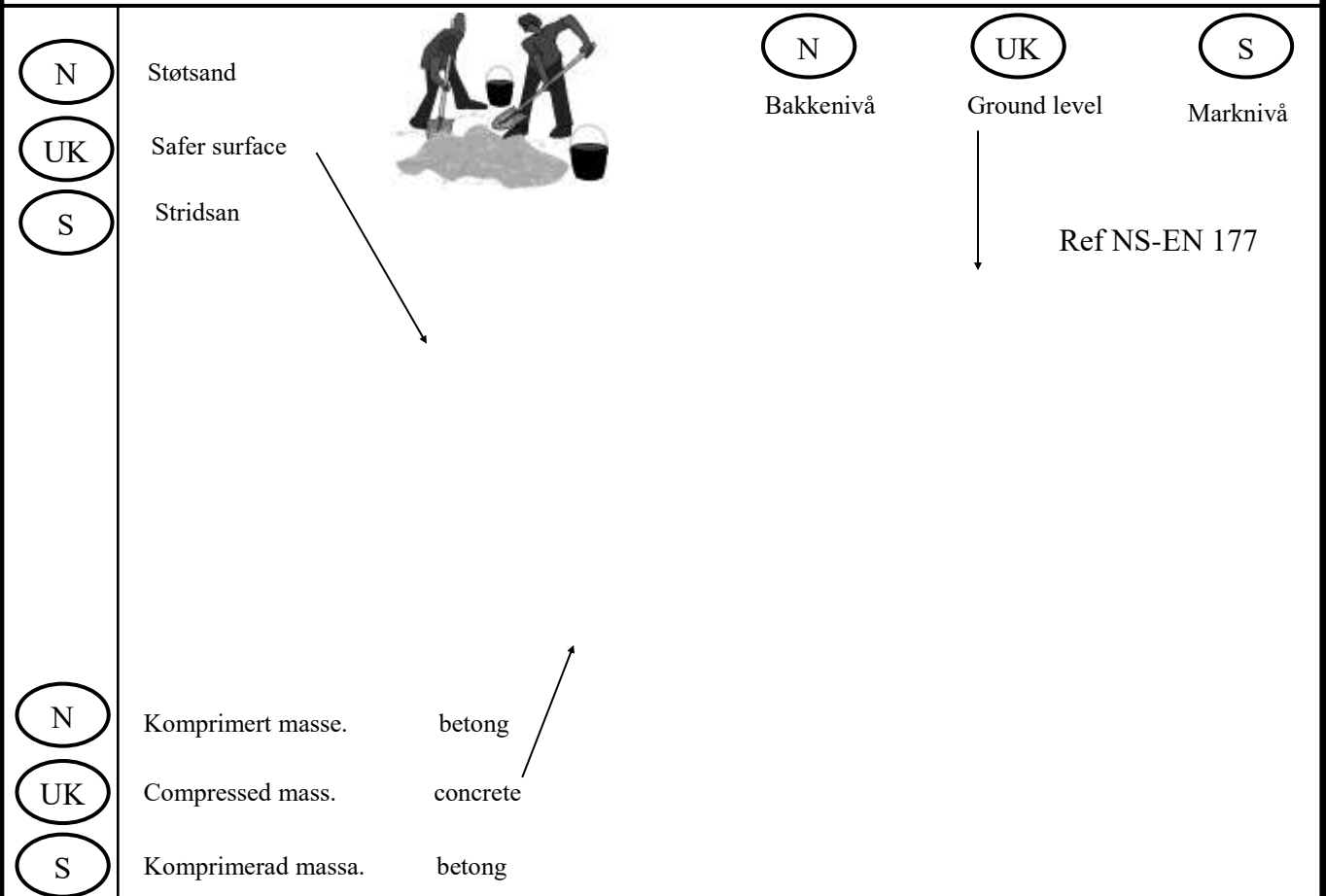

Fundamentering uten betong / Foundation without concrete / Förankring utan betong

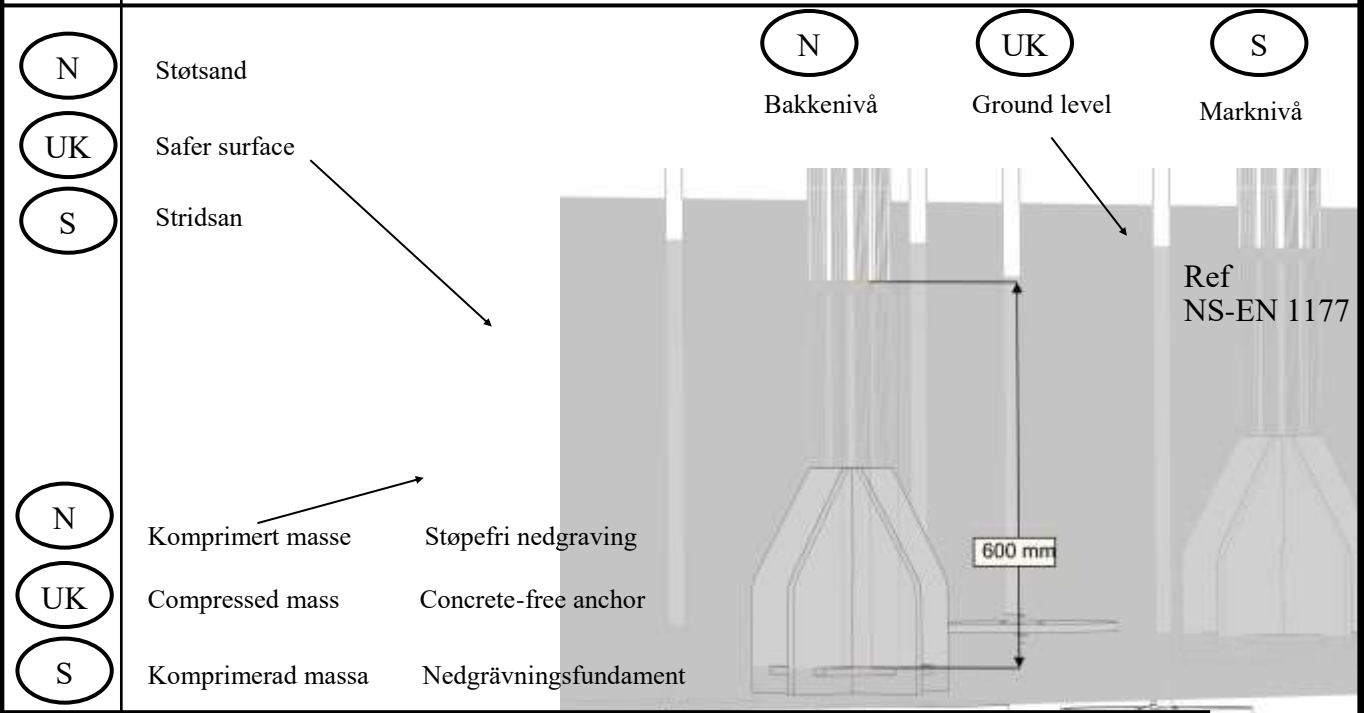

(N)	Alle mål er oppgitt i millimeter
(UK)	Scale measured in mm
(S)	Alla mått är i millimeter.

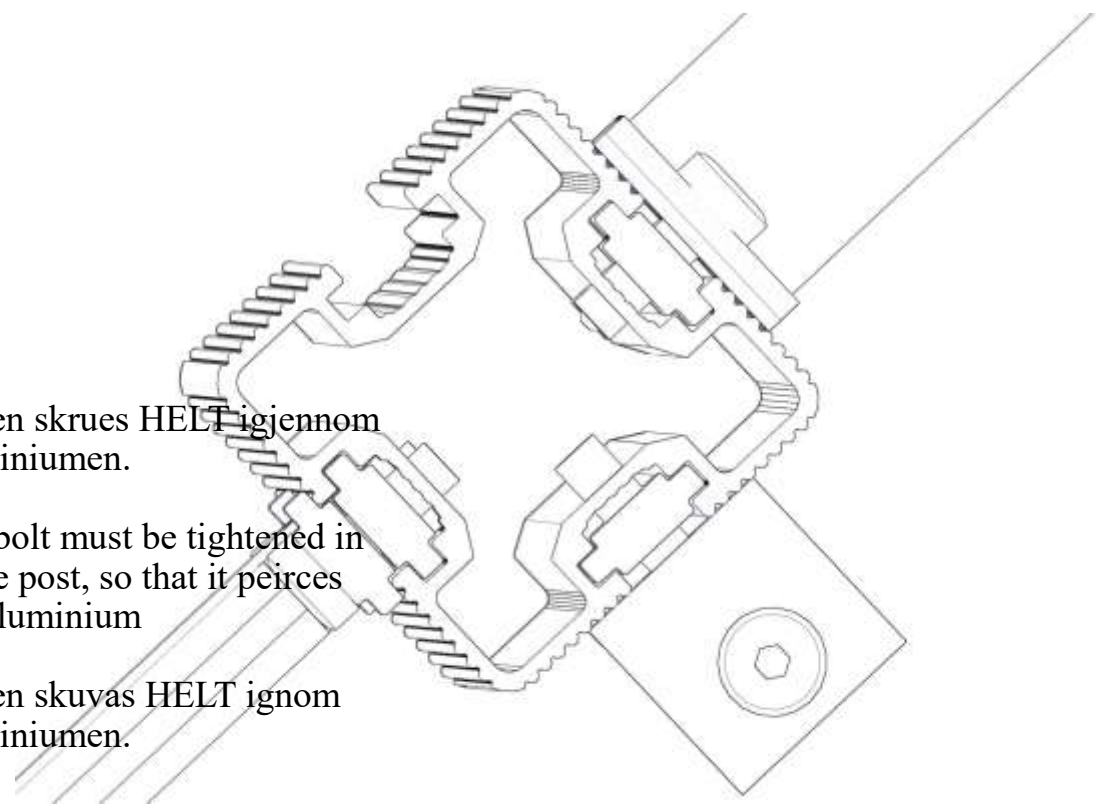
<p data-bbox="119 1556 215 1624">N</p> <p data-bbox="119 1691 215 1758">UK</p> <p data-bbox="119 1848 215 1915">S</p>	 <p data-bbox="239 1579 702 1668">Bolten skrues HELT igjennom aluminiumen.</p> <p data-bbox="239 1691 686 1825">The bolt must be tightened in to the post, so that it peirces the aluminium</p> <p data-bbox="239 1848 662 1937">Bulten skivas HELT ignom aluminiumen.</p>

Fallhøyder / Free height of fall / Fallhöjder

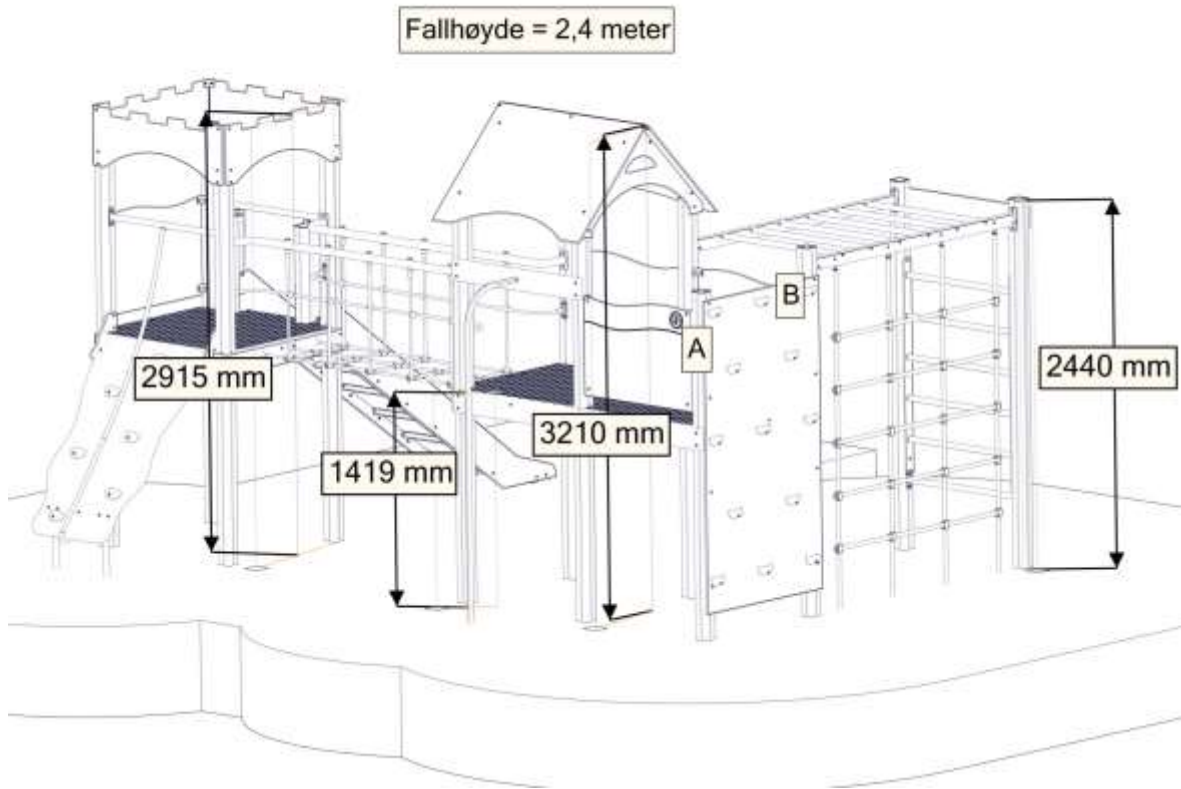

Sikkerhetszone / Safety zone / Säkerhetszon

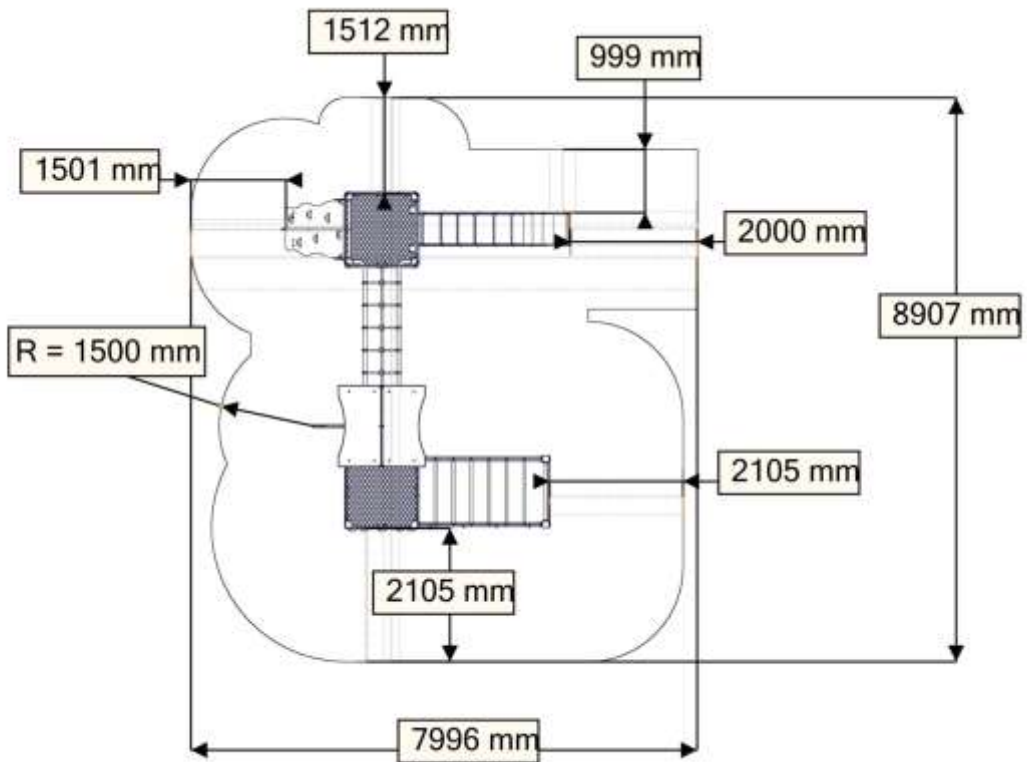

Plassering av forankringer / Ground plan / Placering av förankringar

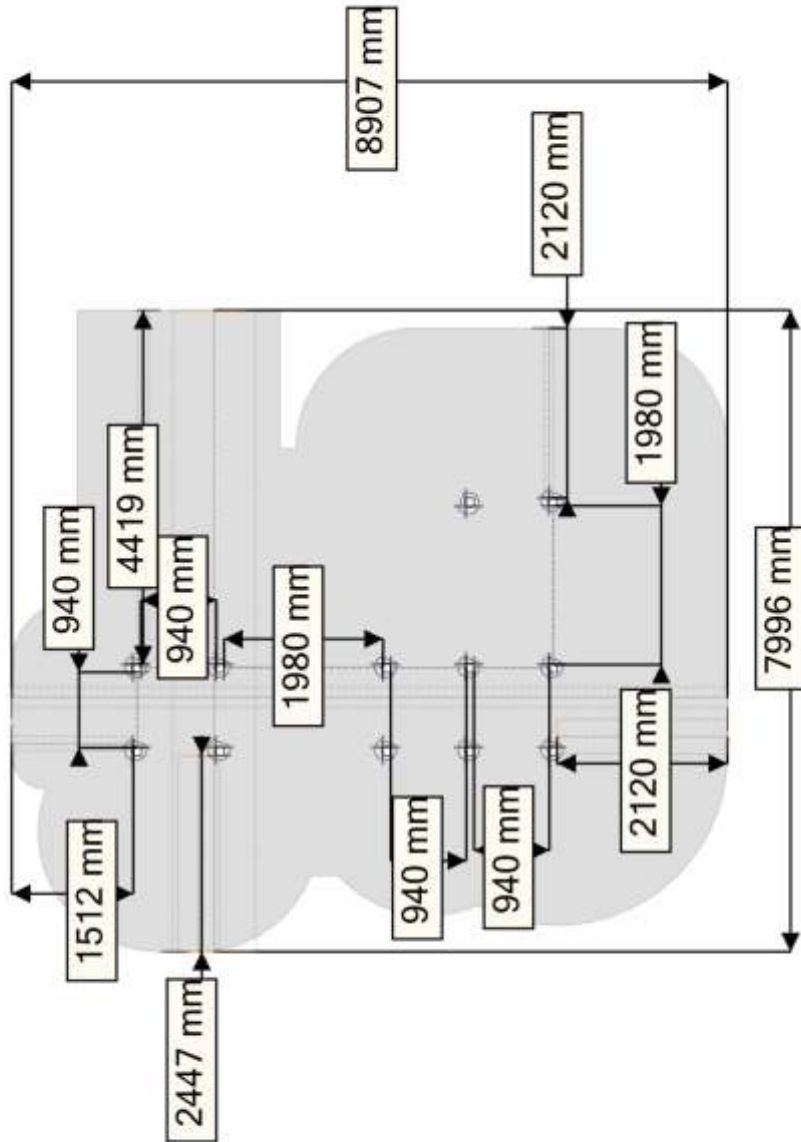

N

Alle mål er oppgitt i millimeter

UK

Scale measured in mm

S

Alla mått är i millimeter.

Montering av lekeapparatet / Assembly instructions / Montering av lekredskapet

10x

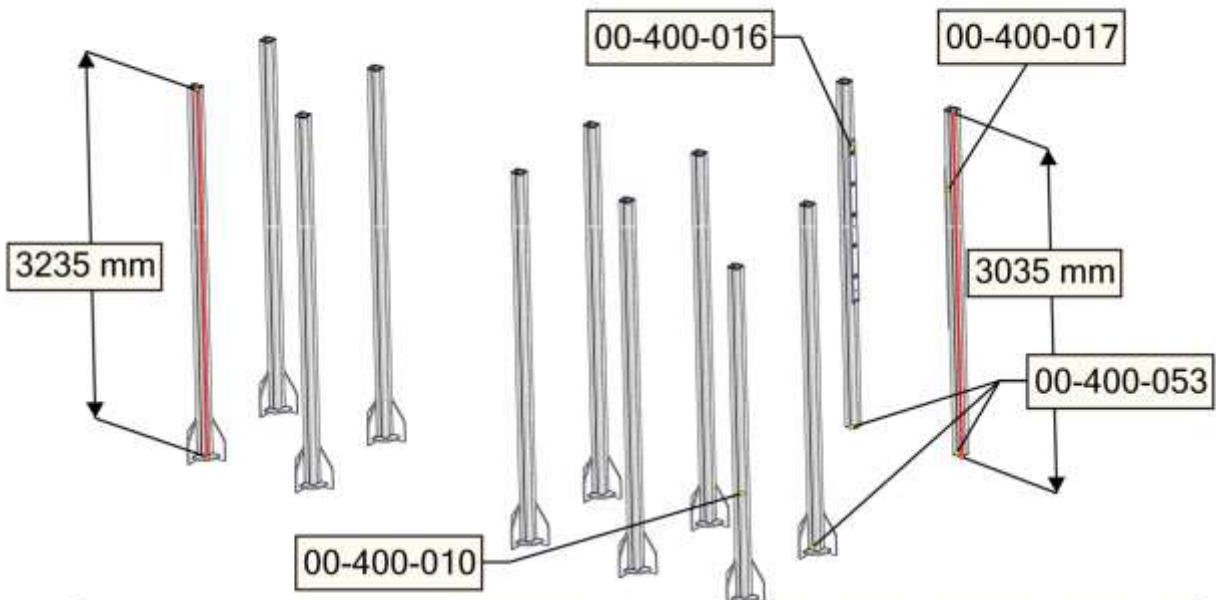
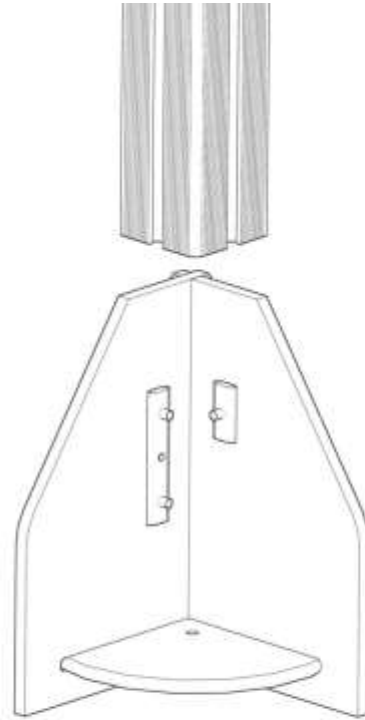

BOM ID	Name	SW Configuration	Artnr (config)	Qty
1	VK95_SFA5117_A-1	600-2635	00-400-009	8
2	VK95_SFA5117_A-1	600-2300	00-400-010	1
3	VK95_SFA5117_A-1	600-2435	00-400-053	3

Montering av lekeapparatet / Assembly instructions / Montering av lekredskapet

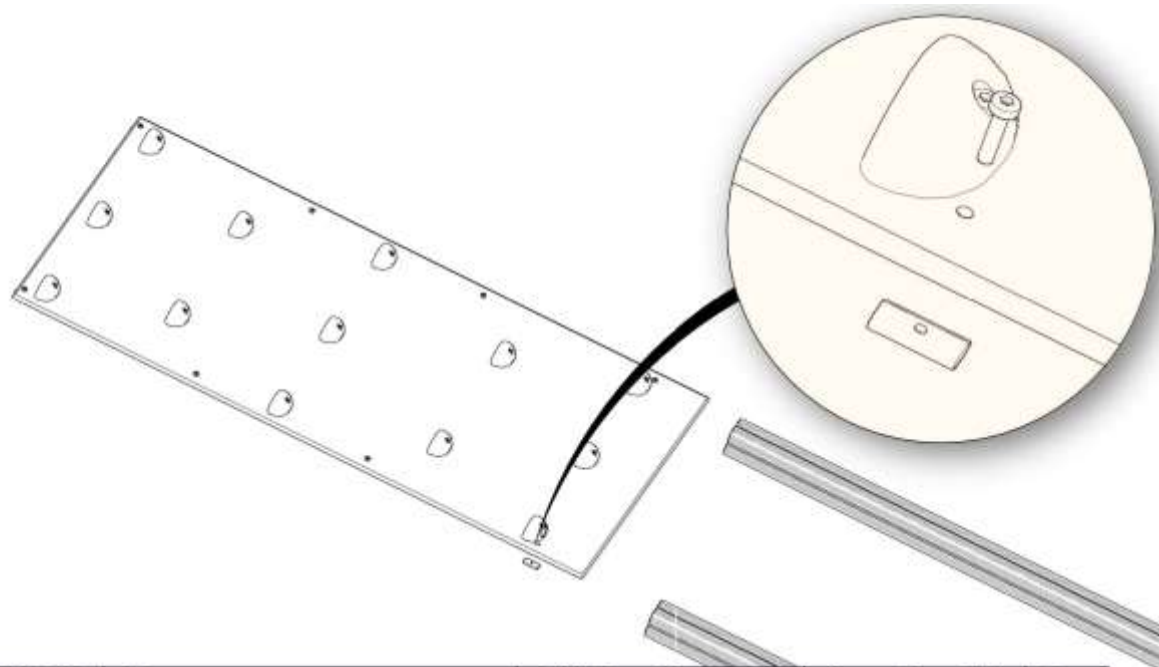
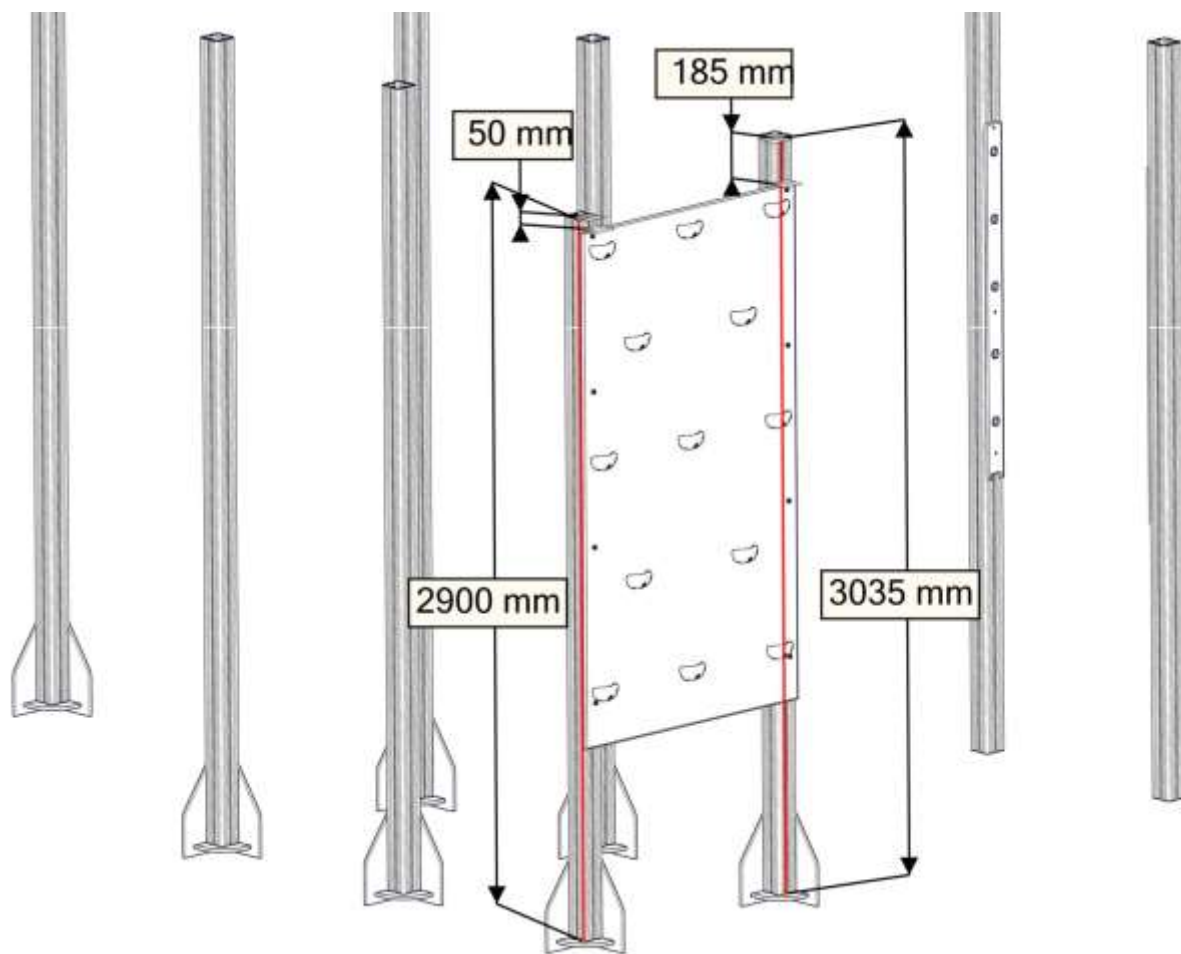

BOM ID	Name	SW Configuration	Artnr (config)	Qty
1	Klatrevegge_2075x1130-1	Default	00-400-720	1
2	TorxM8-1	TXM8x35	04-000-035	8
3	brikke_SFA5116-1	50_1T	04-060-050	8

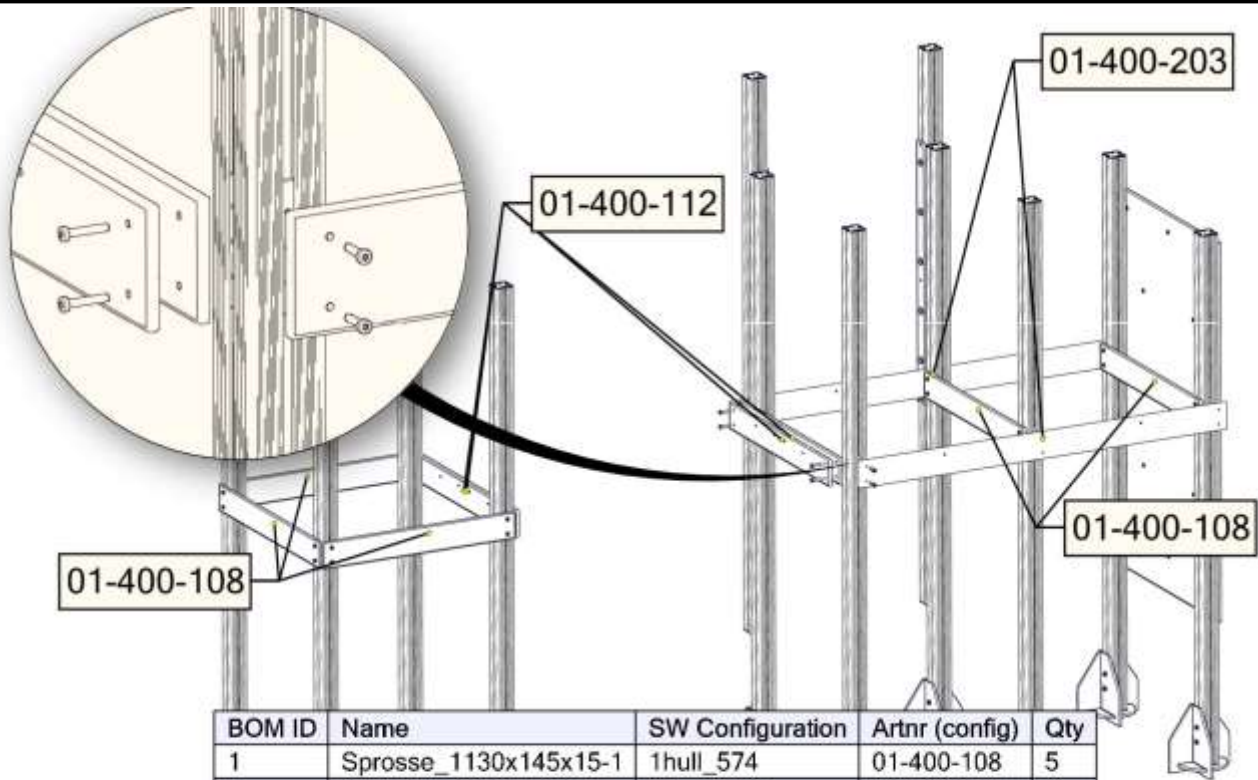
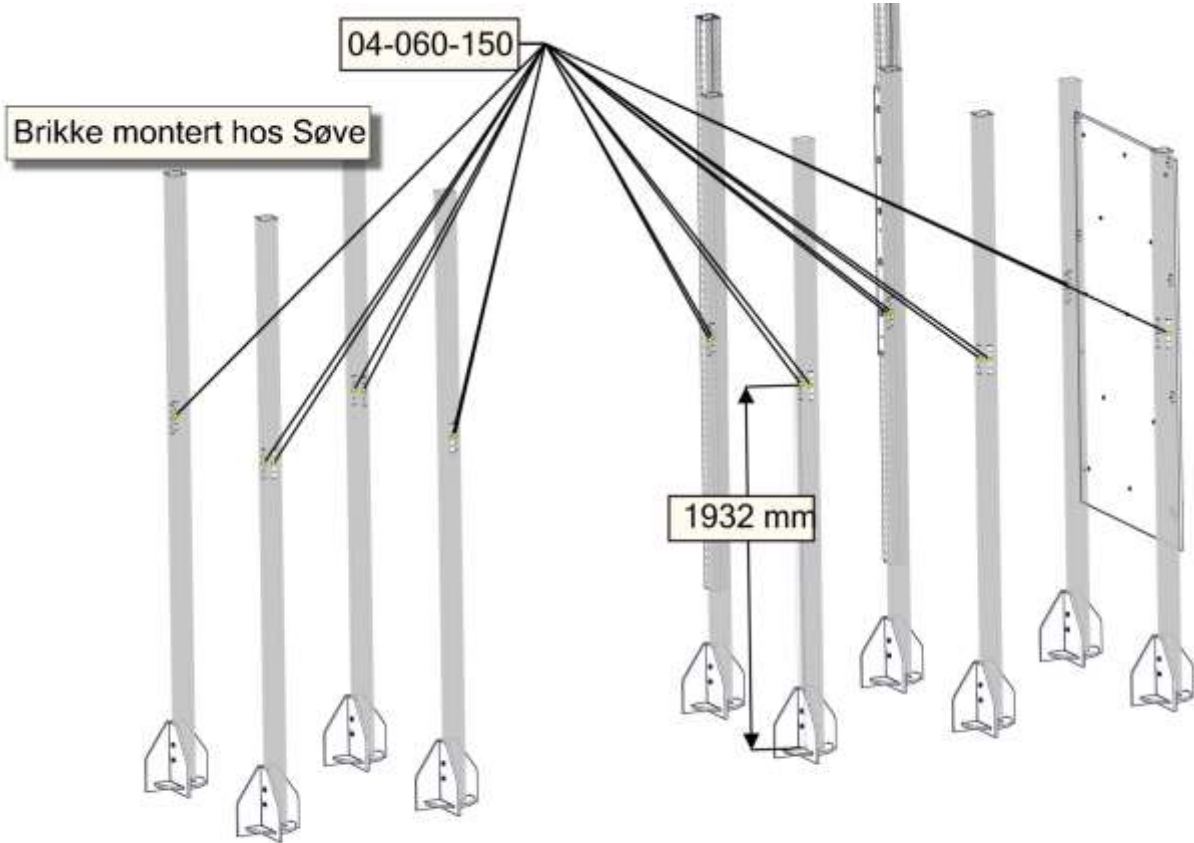

BOM ID	Name	SW Configuration	Artnr (config)	Qty
1	Sprosse_1130x145x15-1	1hull_574	01-400-108	5
2	Sprosse_1130x145x15-	3H polyfix	01-400-112	4
3	sprosse_2165x145x15-1	Default	01-400-203	2
4	TorxM8-	TXM8x35	04-000-035	32
5	TorxM8-	TXM8x50	04-000-050	8

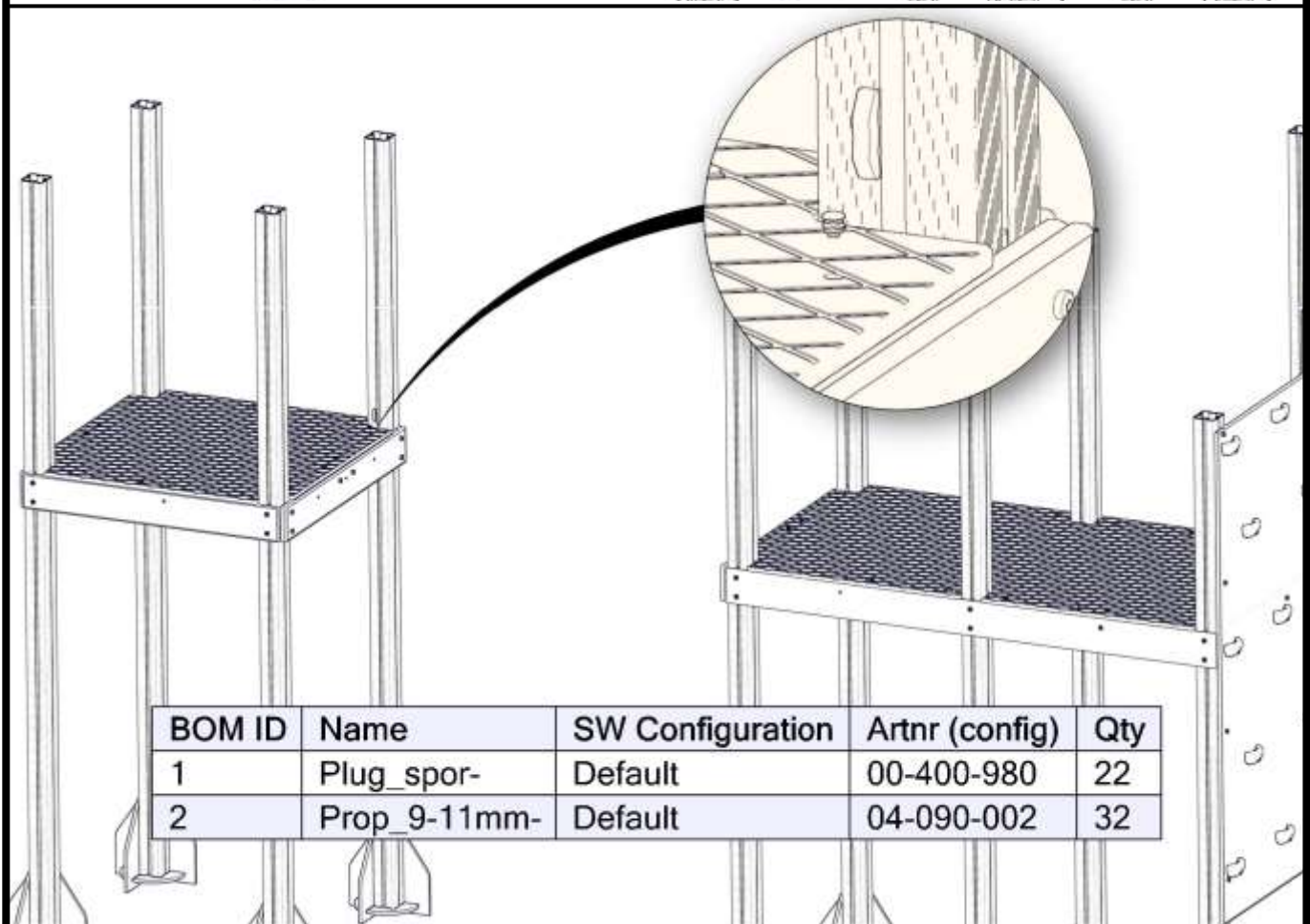
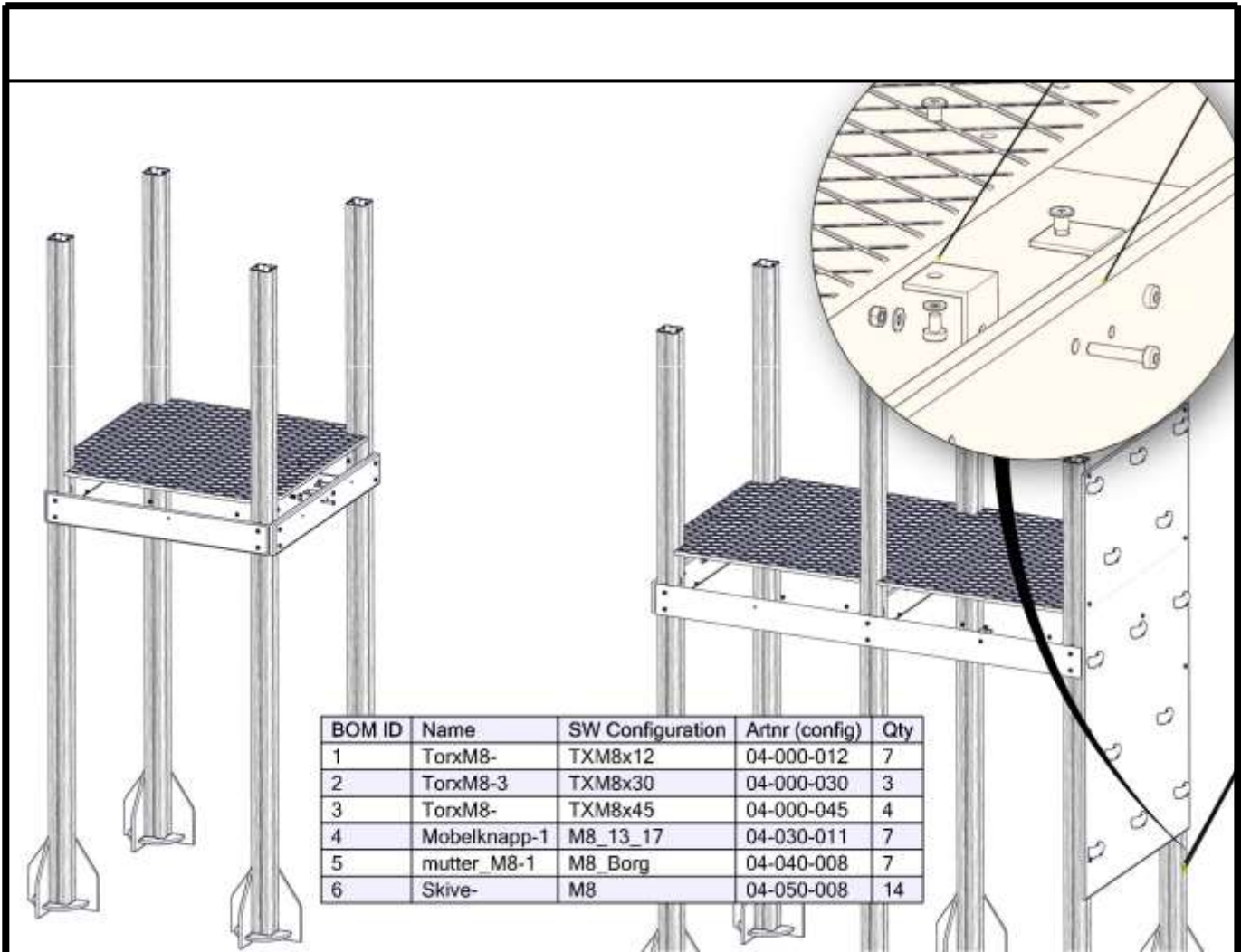

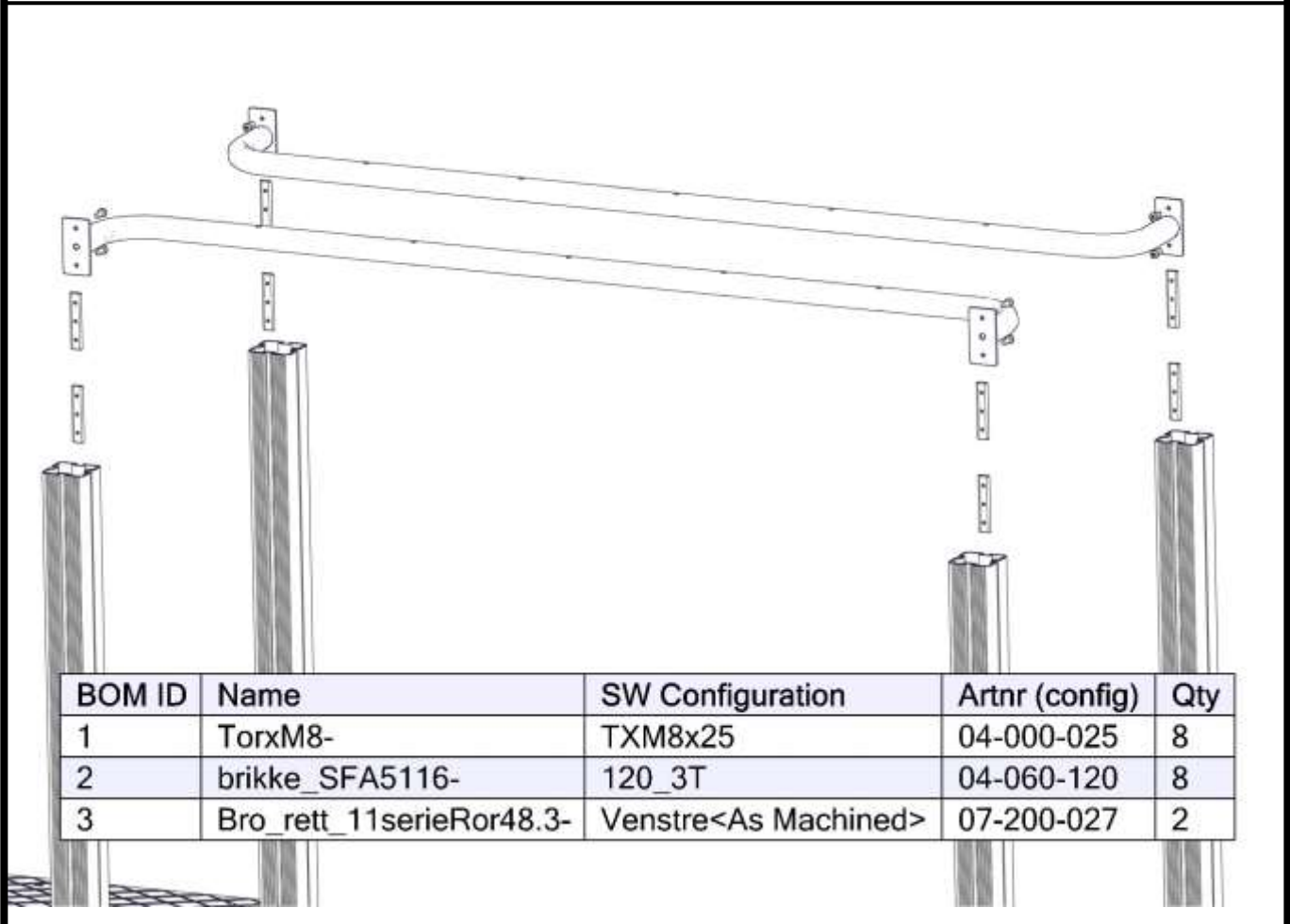
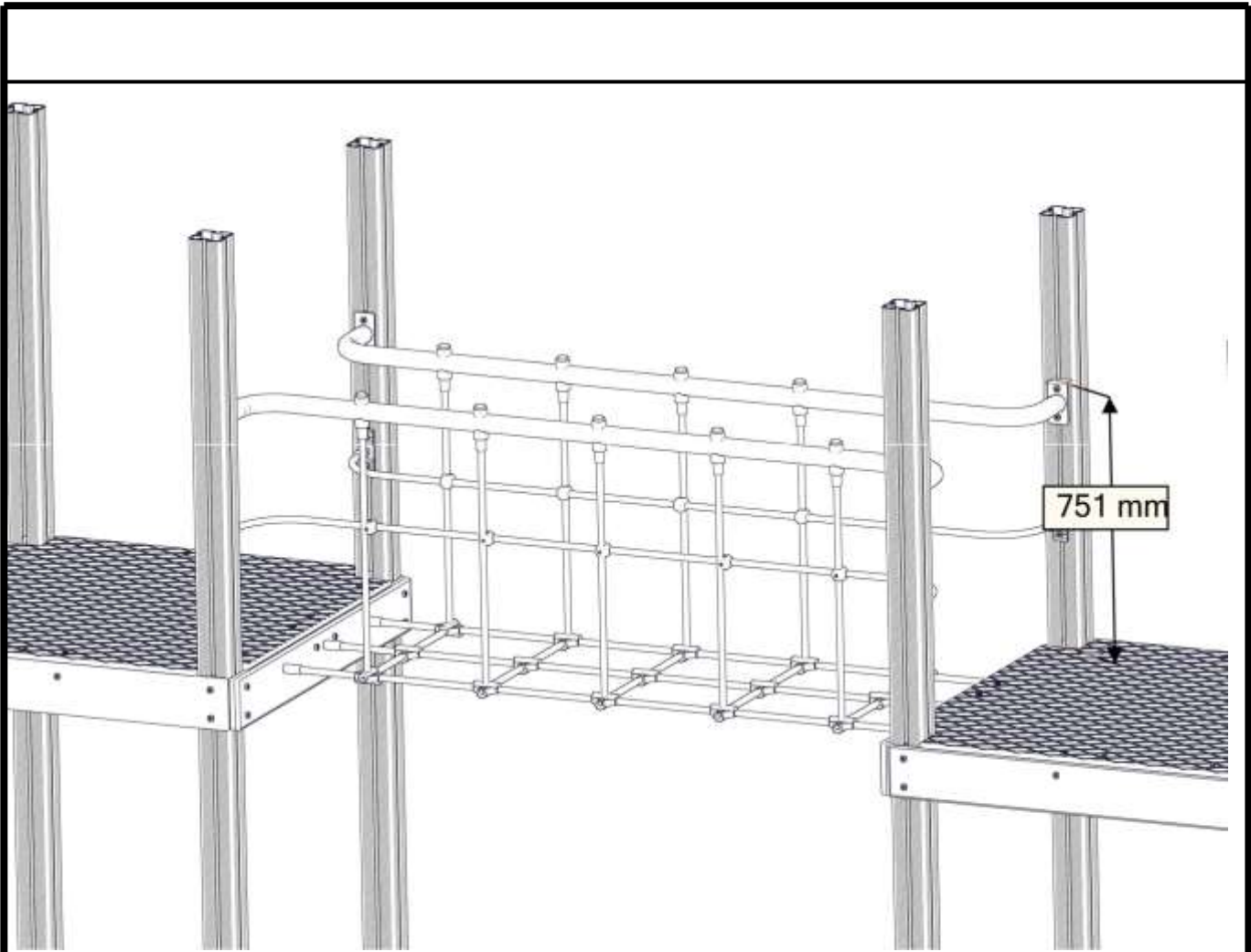

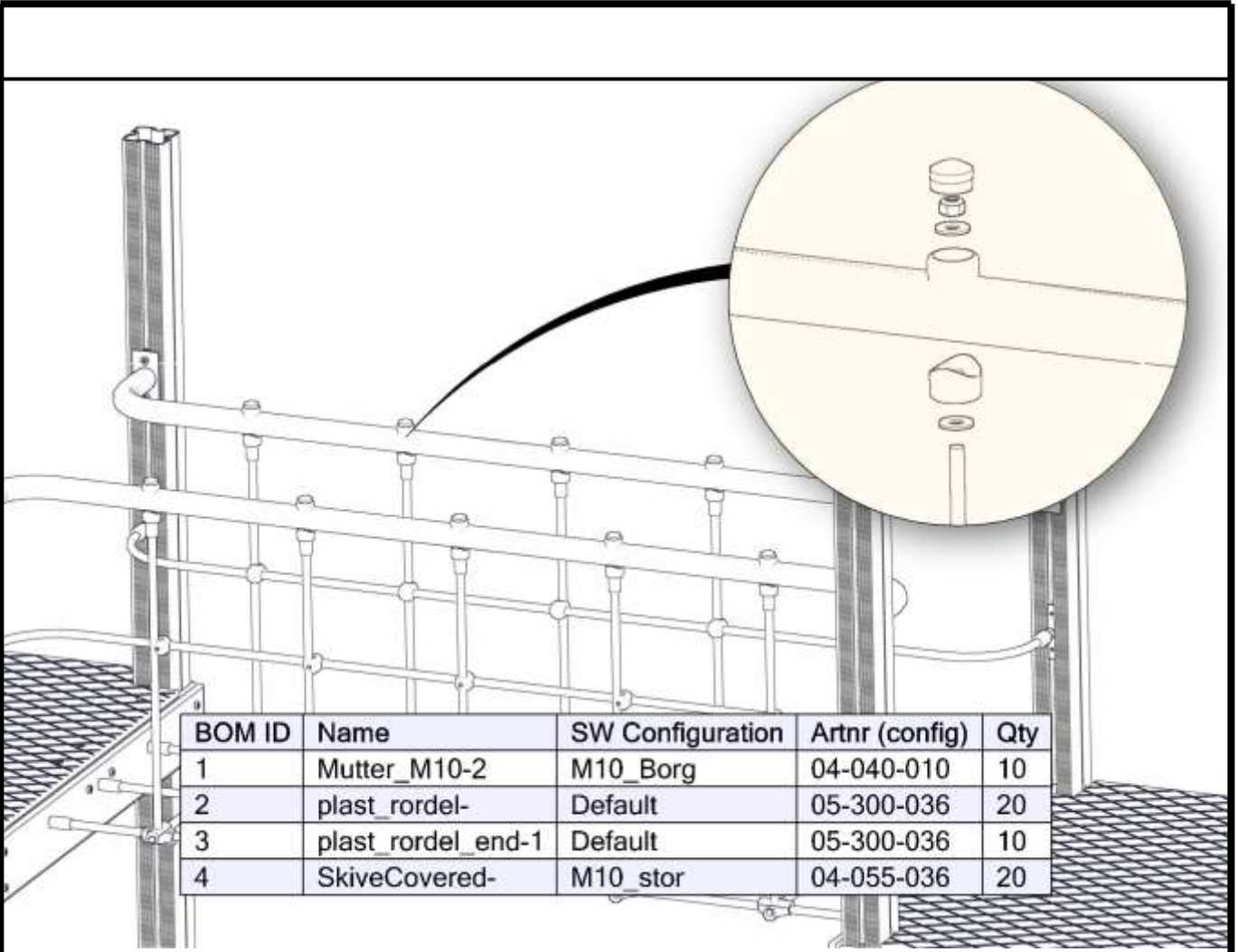

BOM ID	Name	SW Configuration	Artnr (config)	Qty
1	Mutter_M10-2	M10_Borg	04-040-010	10
2	plast_rordel-	Default	05-300-036	20
3	plast_rordel_end-1	Default	05-300-036	10
4	SkiveCovered-	M10_stor	04-055-036	20

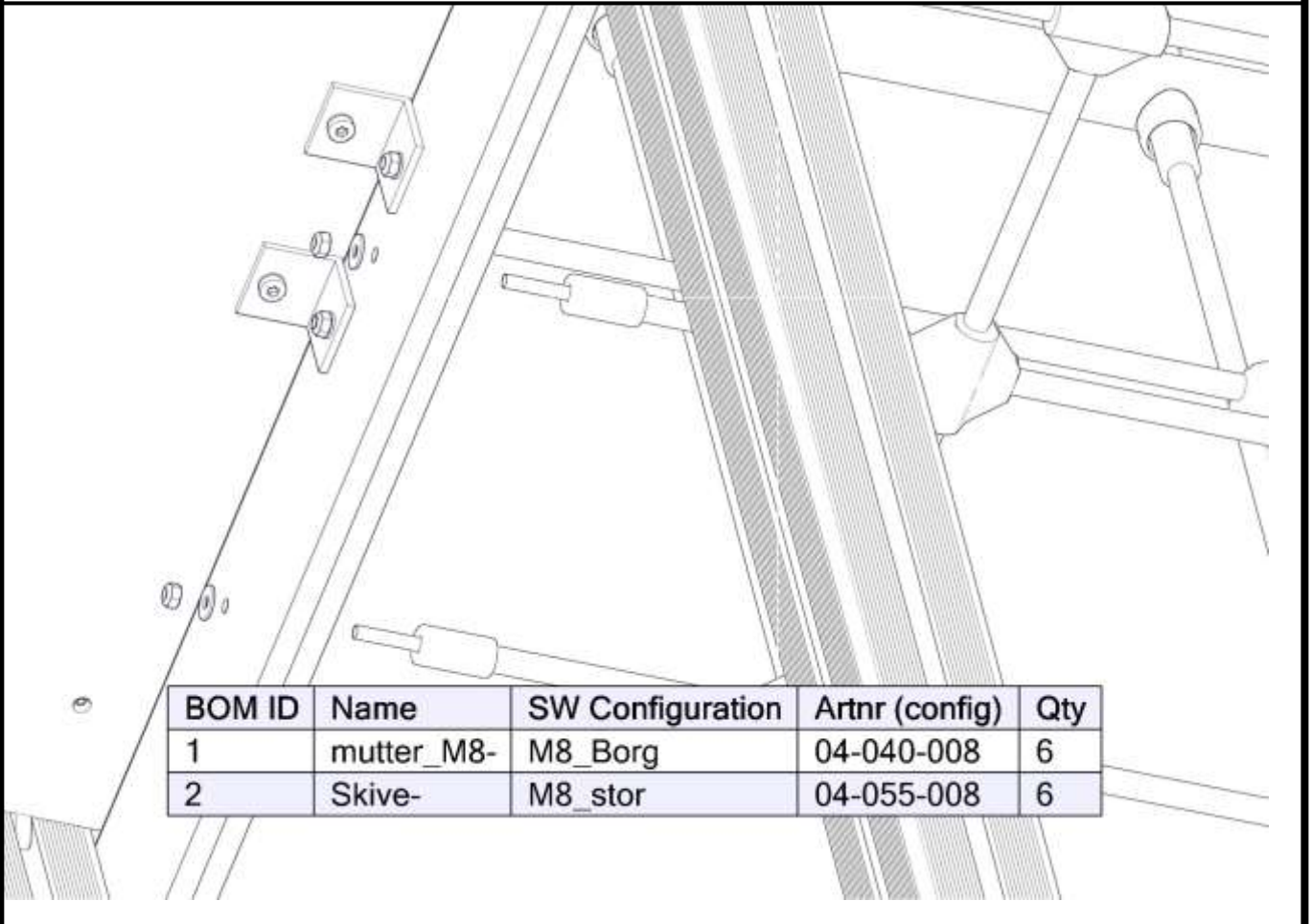

BOM ID	Name	SW Configuration	Artnr (config)	Qty
1	mutter_M8-	M8_Borg	04-040-008	6
2	Skive-	M8_stor	04-055-008	6

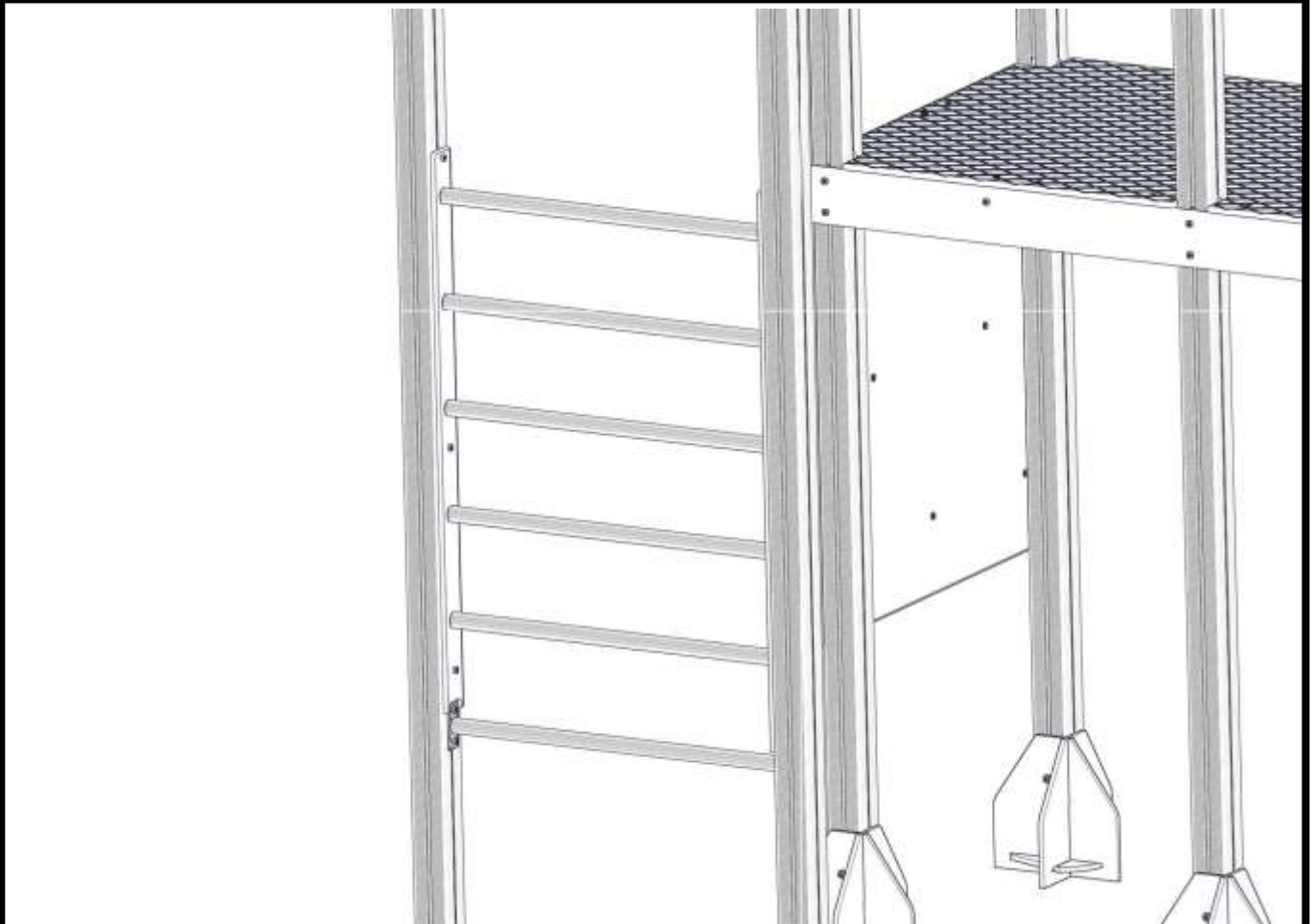
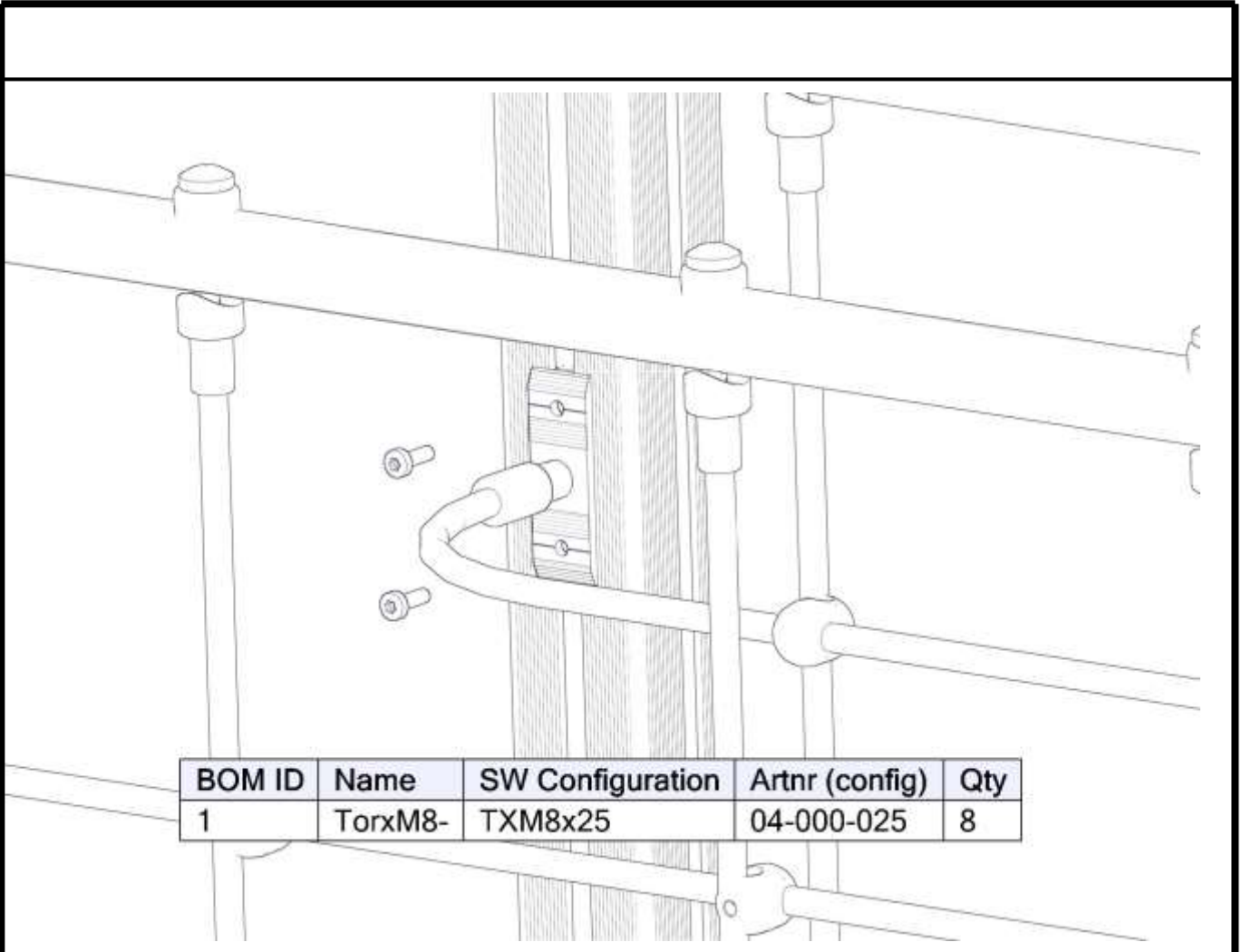

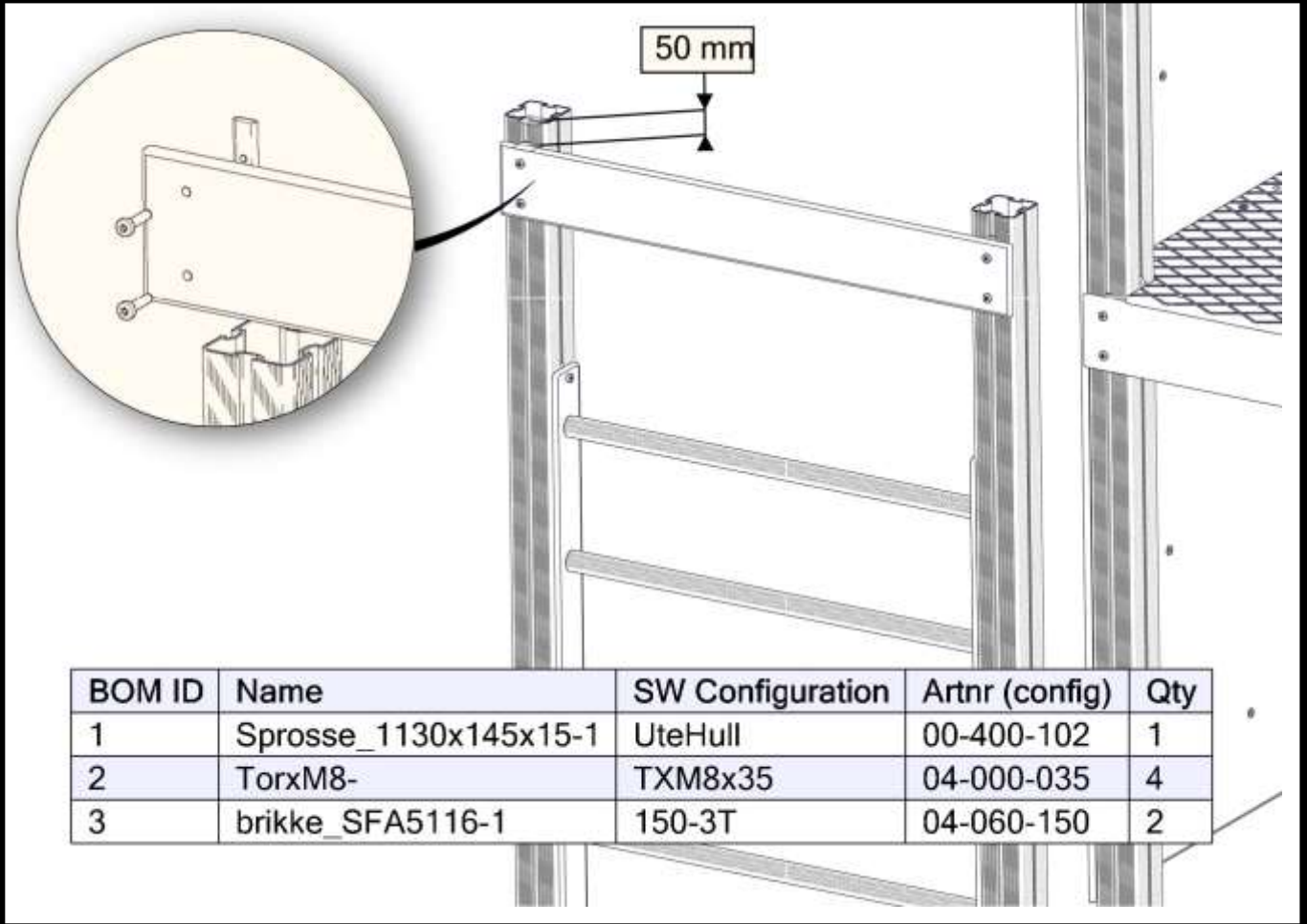
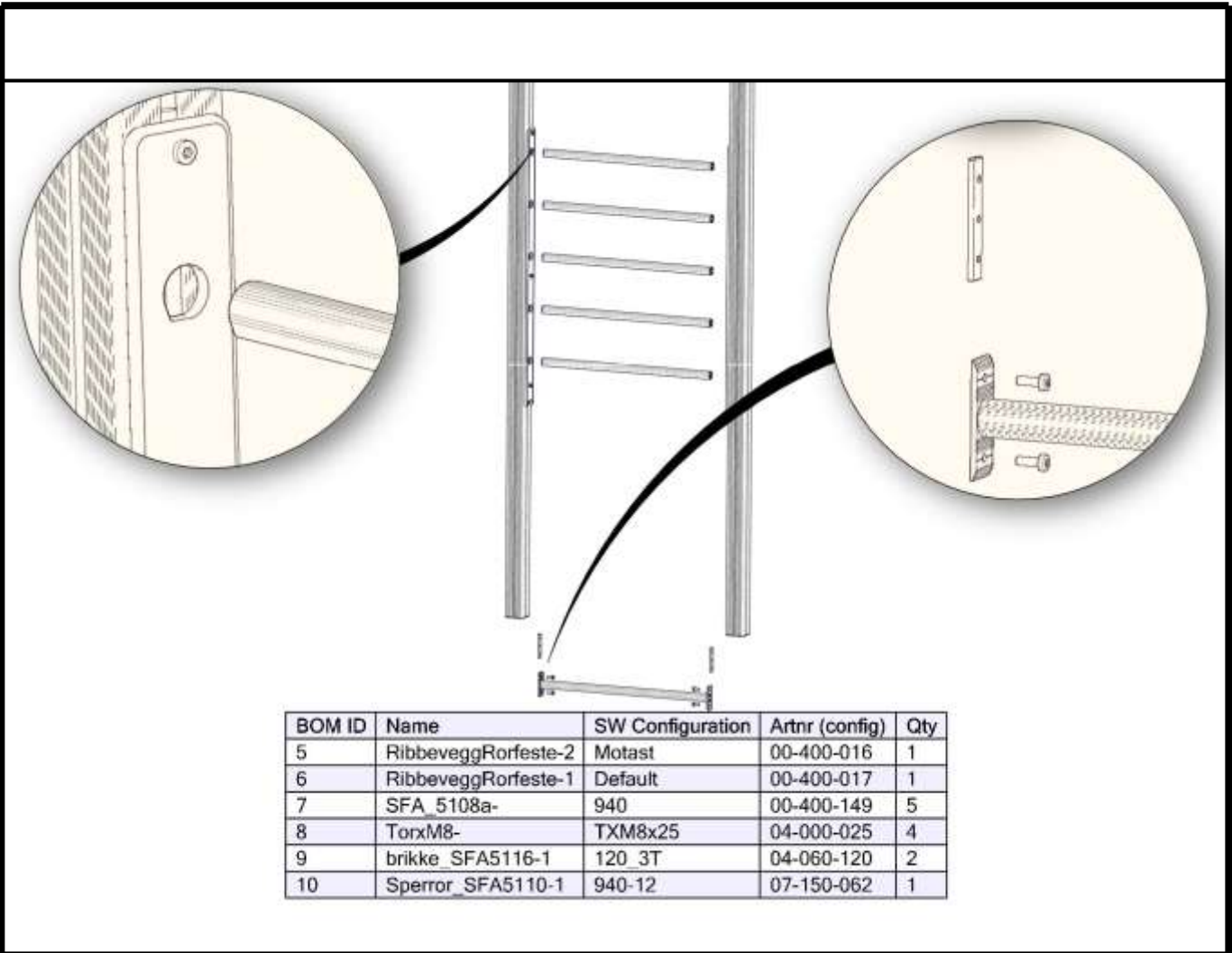

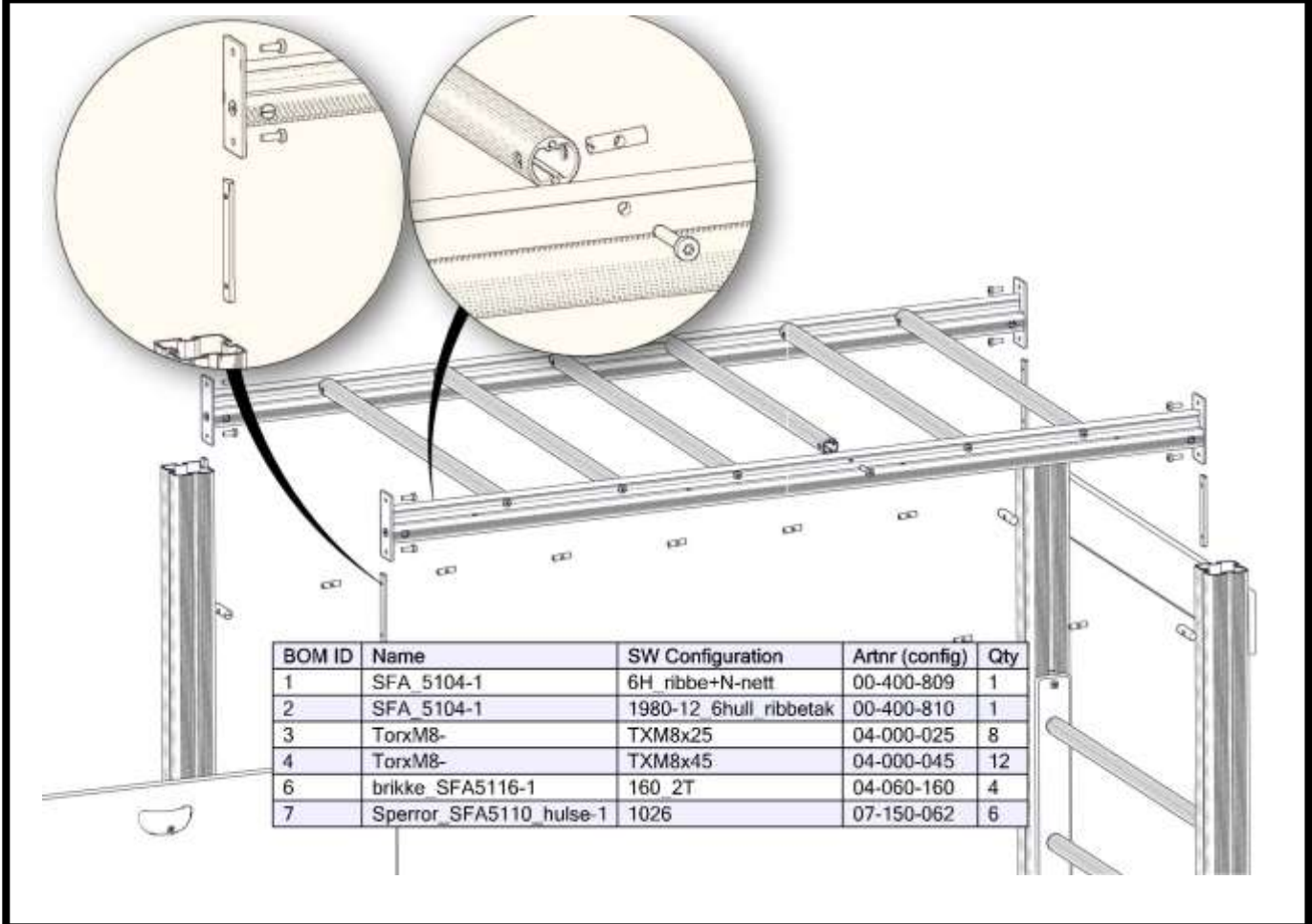
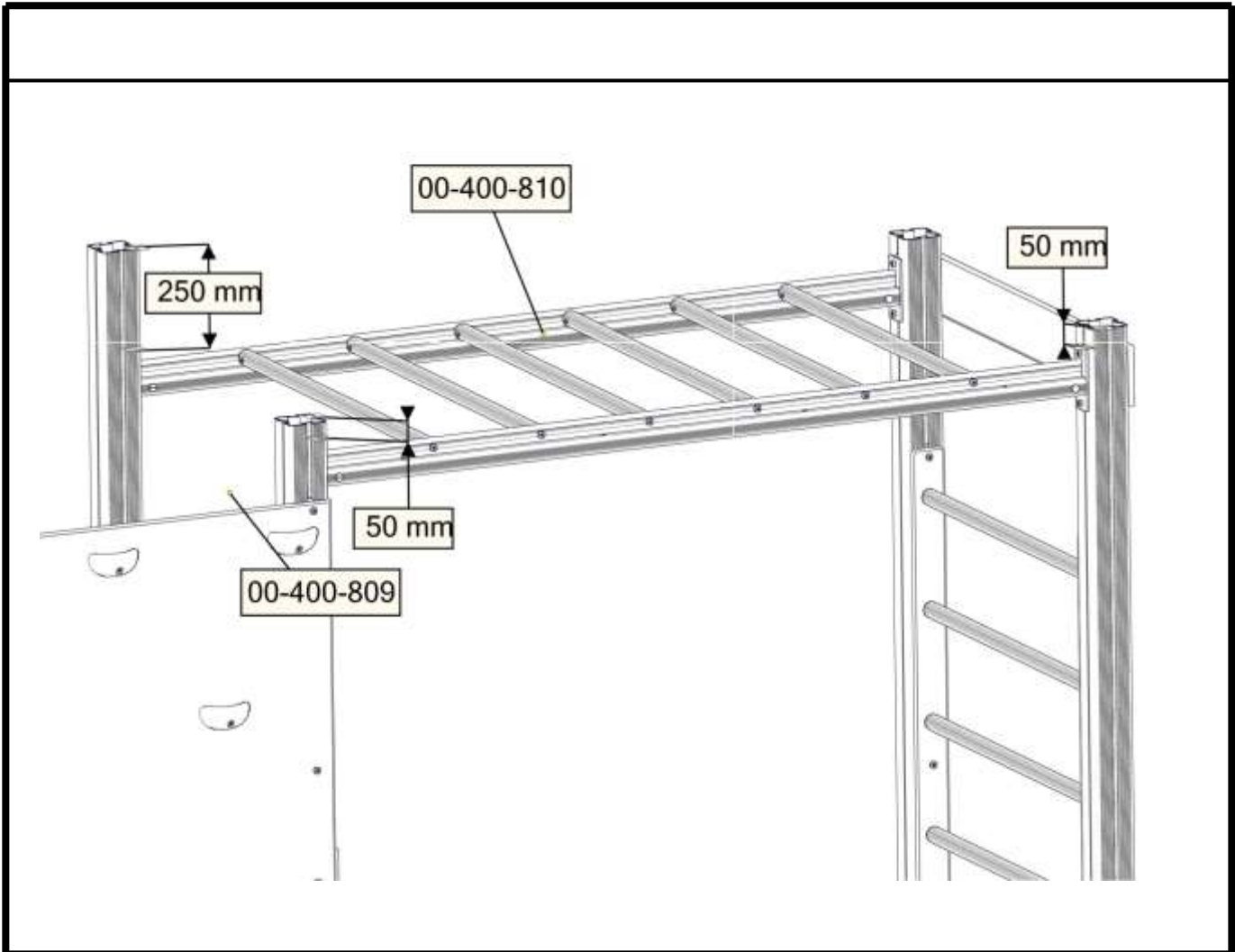

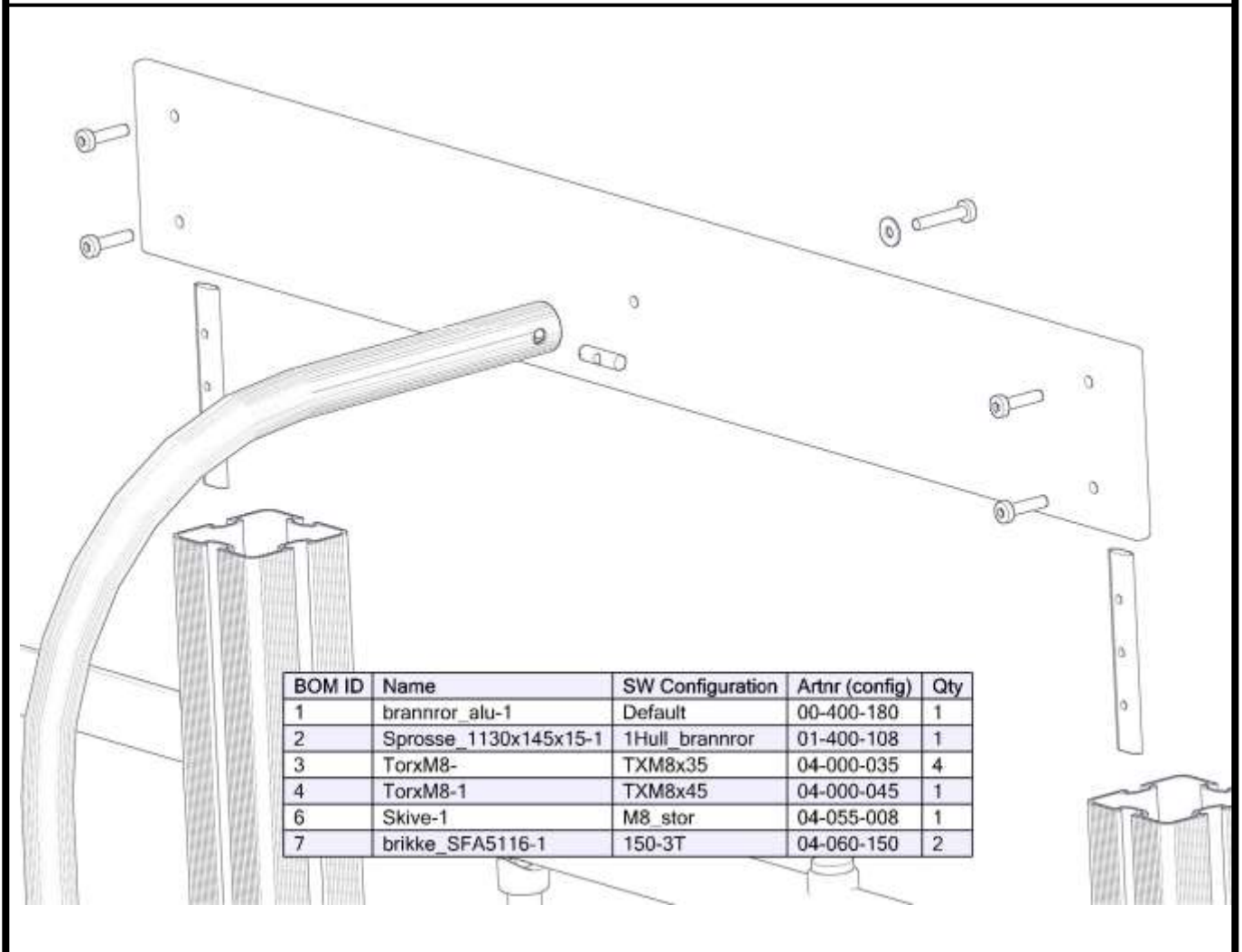
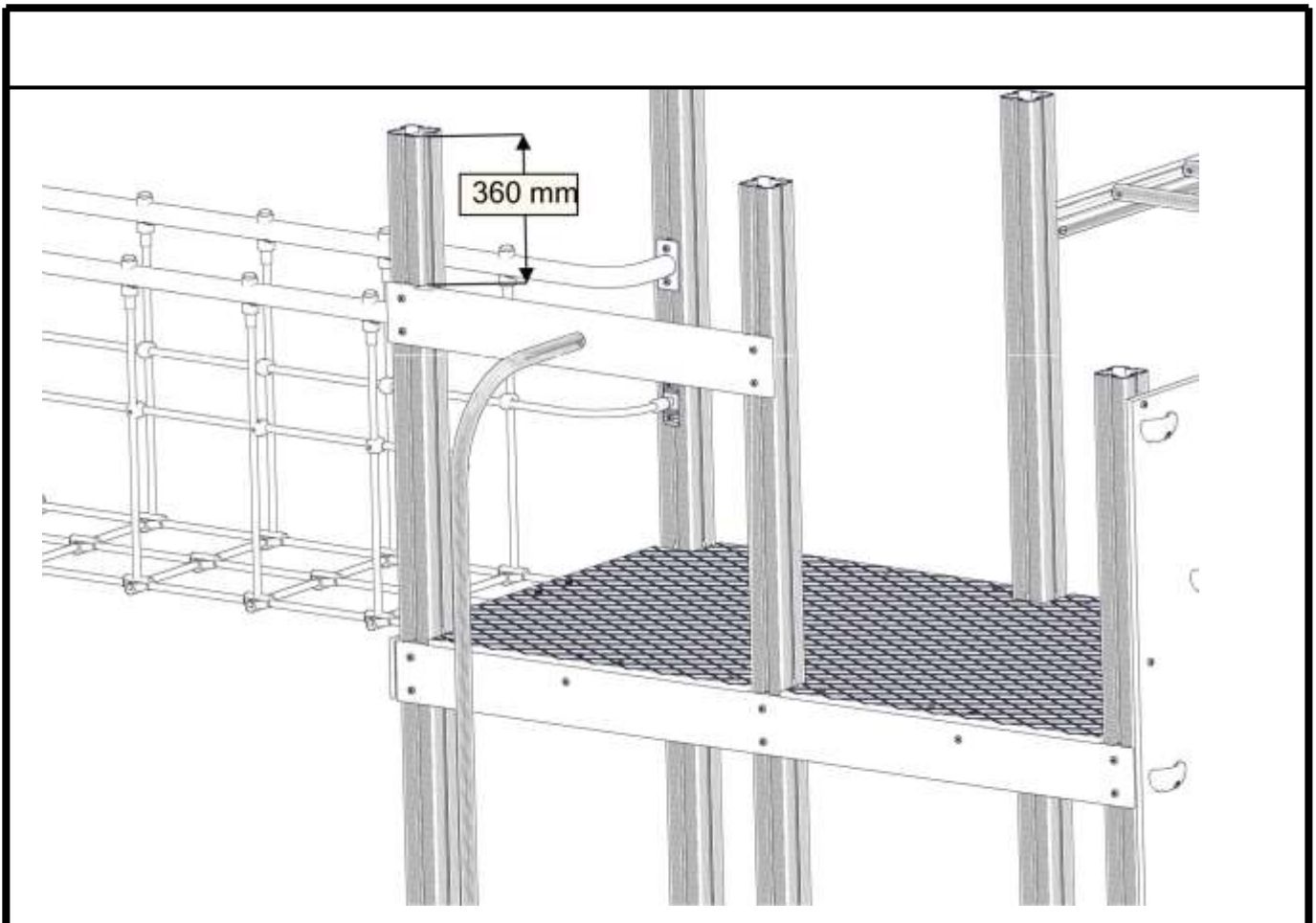

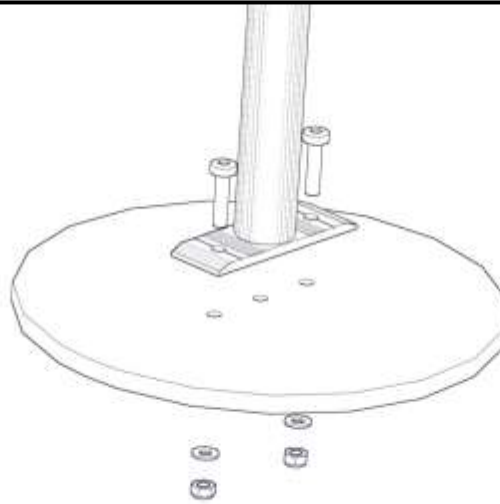

BOM ID	Name	SW Configuration	Artnr (config)	Qty
1	Fundament_platte_2H-1	Hoh80	00-003-106	1
2	TorxM8-	TXM8x35	04-000-035	2
3	mutter M8-	M8_Borg	04-040-008	2
4	Skive-	M8	04-050-008	2

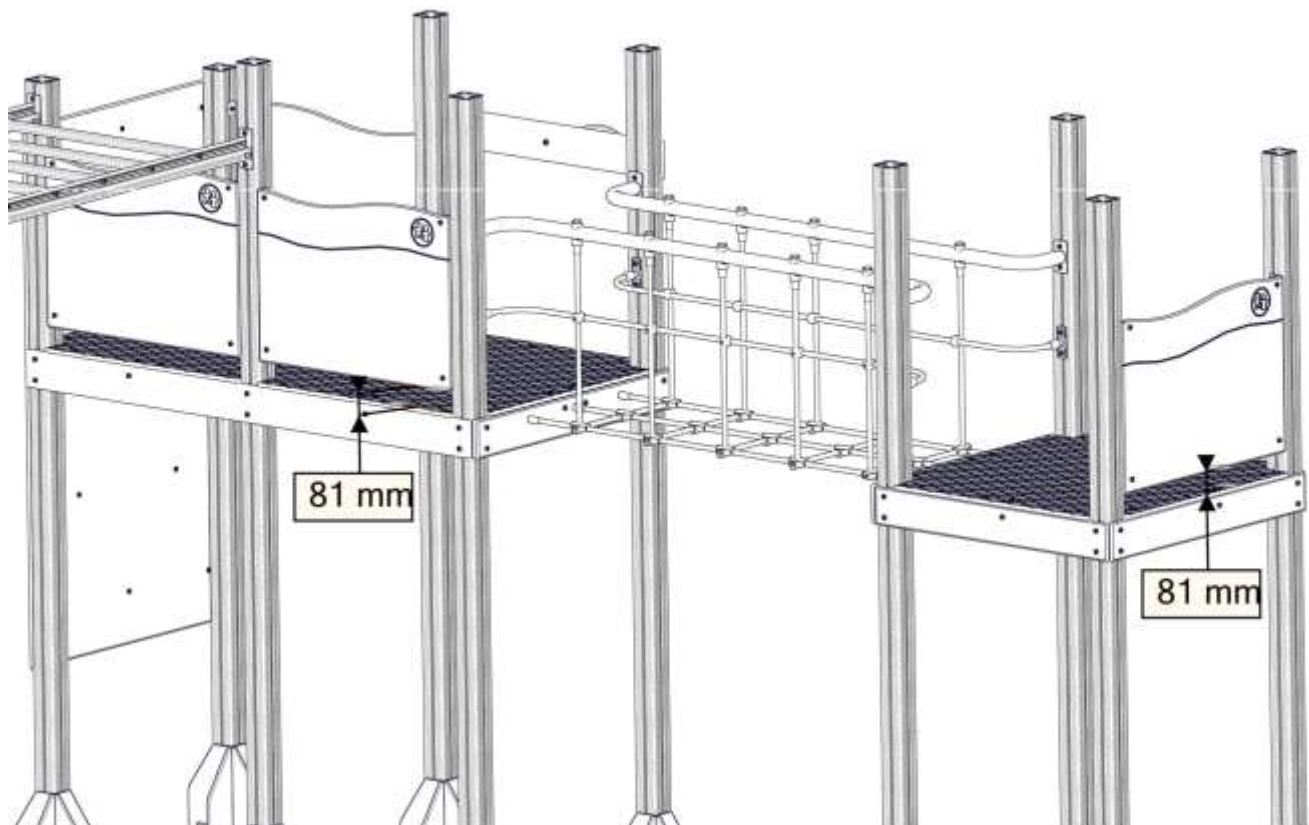

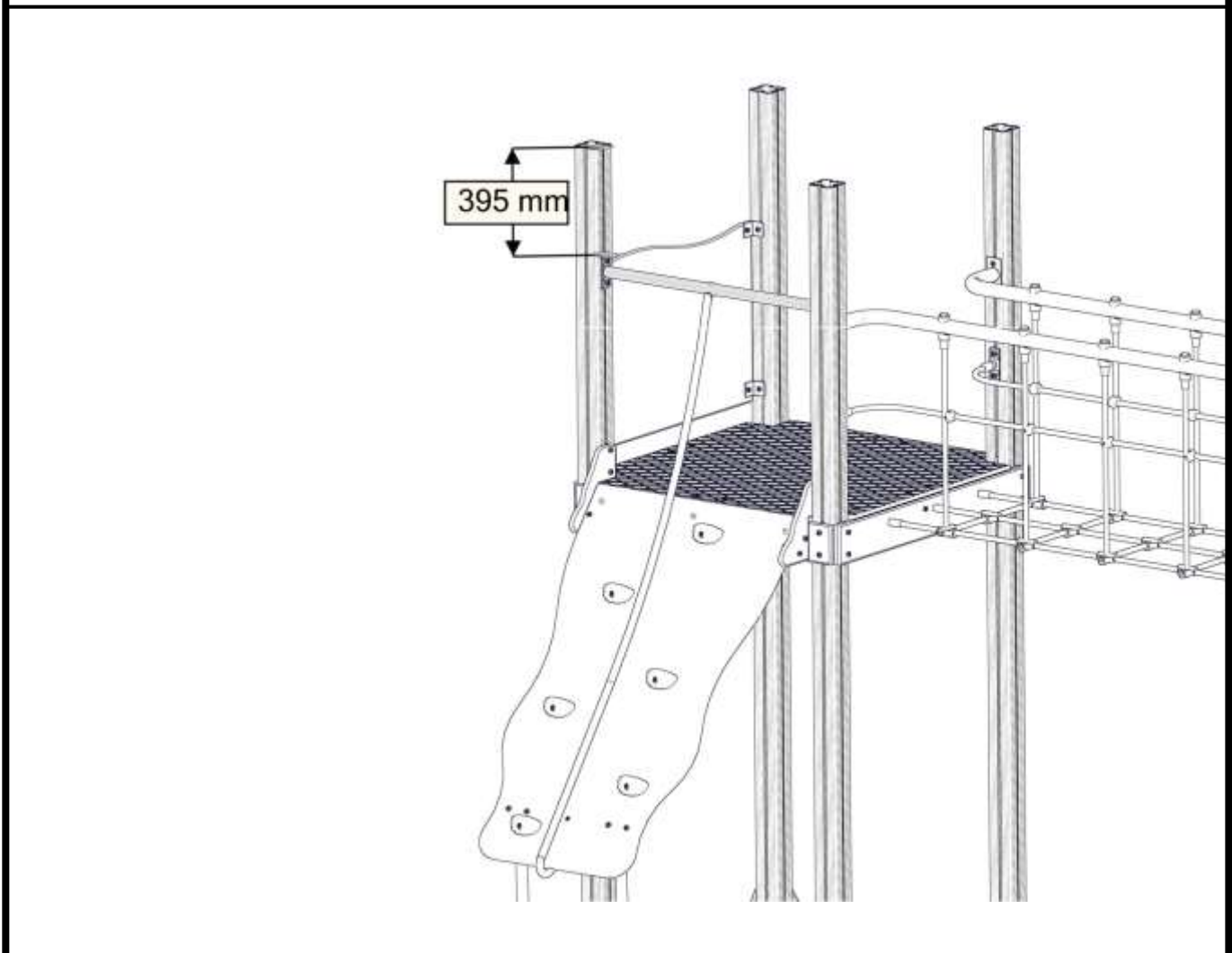
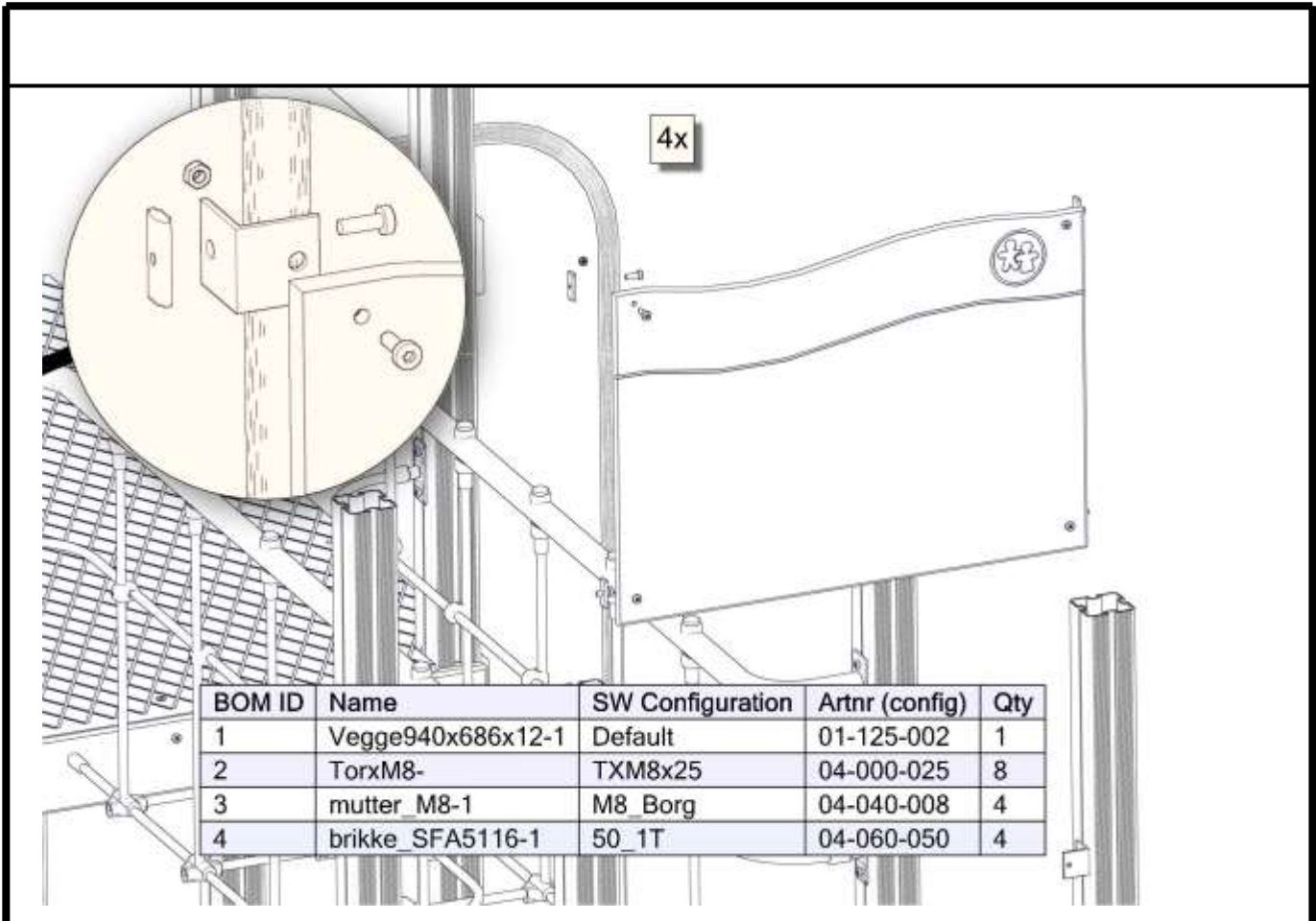

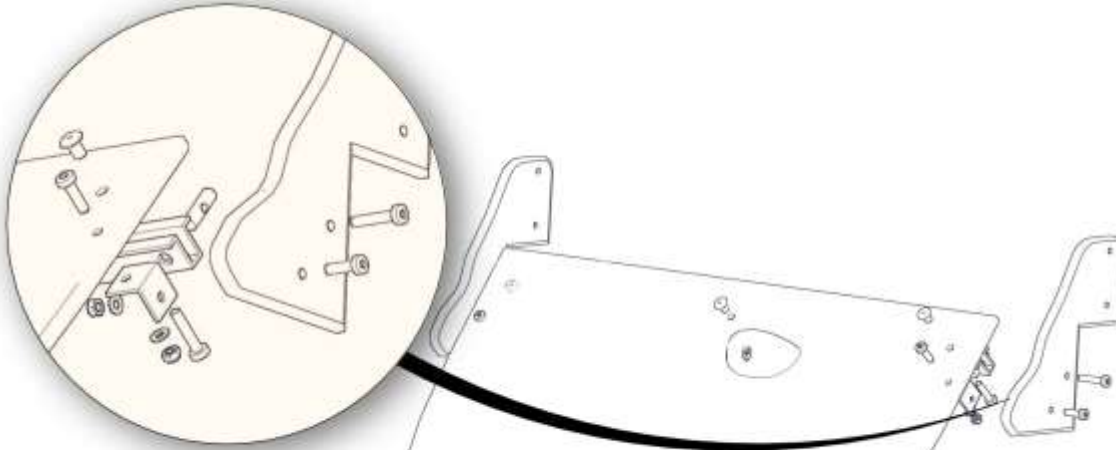

BOM ID	Name	SW Configuration	Artnr (config)	Qty
4	opptrekkplate-1	Default	01-129-112	1
5	FesteOpptrekk-	Default	01-129-113	2
6	SFA_5105a-1	910_opptrekk	02-500-086	1
7	TorxM8-	TXM8x30	04-000-030	4
8	TorxM8-	TXM8x40	04-000-040	3
9	TorxM8-	TXM8x45	04-000-045	2

BOM ID	Name	SW Configuration	Artnr (config)	Qty
11	Mobelknapp_R-	M8_16	04-030-016	3
12	mutter_M8-	M8_Borg	04-040-008	4
13	Skive-	M8	04-050-008	4
14	35x35x3-1	9mm	04-070-035	2

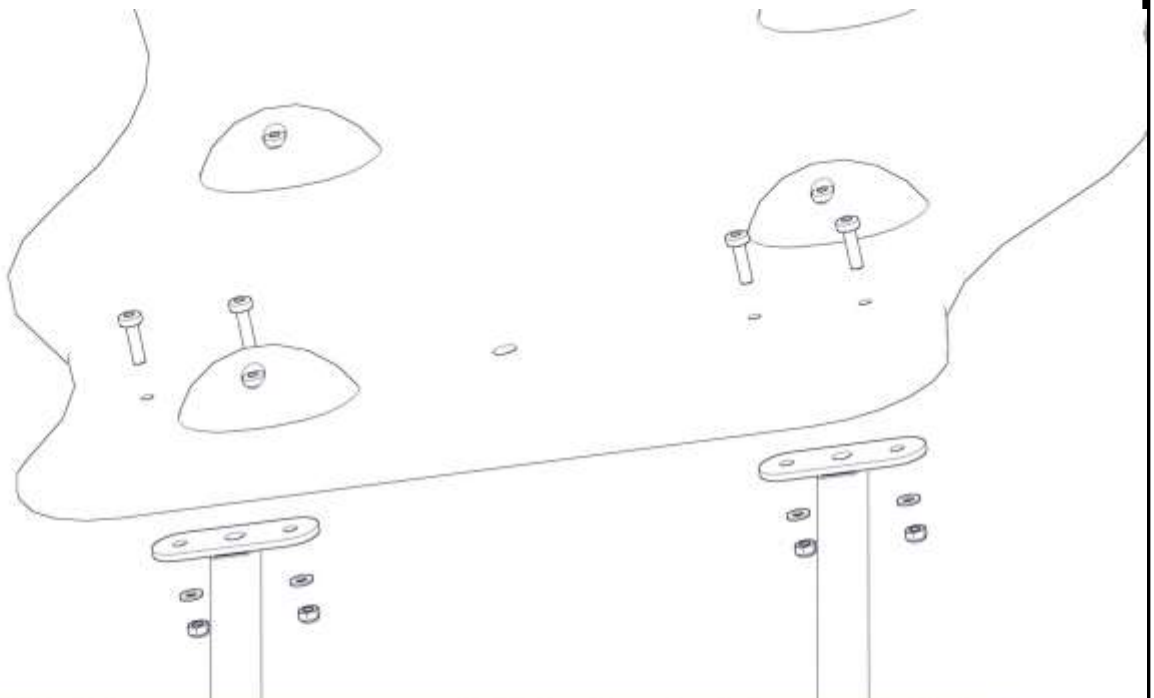

BOM ID	Name	SW Configuration	Artnr (config)	Qty
1	forankeringOpptrekksplate-	Default	01-129-114	2
2	TorxM8-1	TXM8x30	04-000-030	4
3	mutter_M8-1	M8_Borg	04-040-008	4
4	Skive-1	M8	04-050-008	4

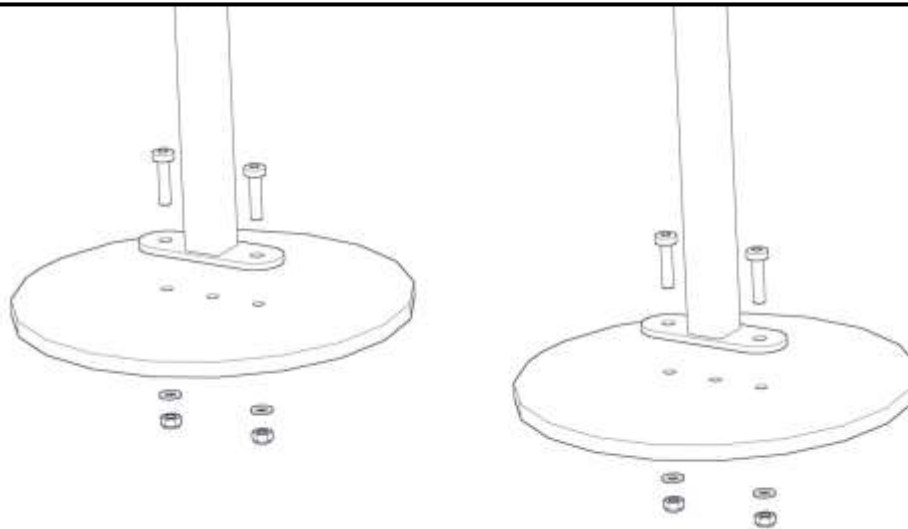

BOM ID	Name	SW Configuration	Artnr (config)	Qty
1	Fundament_platte_2H-	Hoh80	00-003-106	2
2	Torxm8-1	TXM8x35	04-000-035	4
3	mutter_M8-	M8_Borg	04-040-008	4
4	Skive-	M8	04-050-008	4

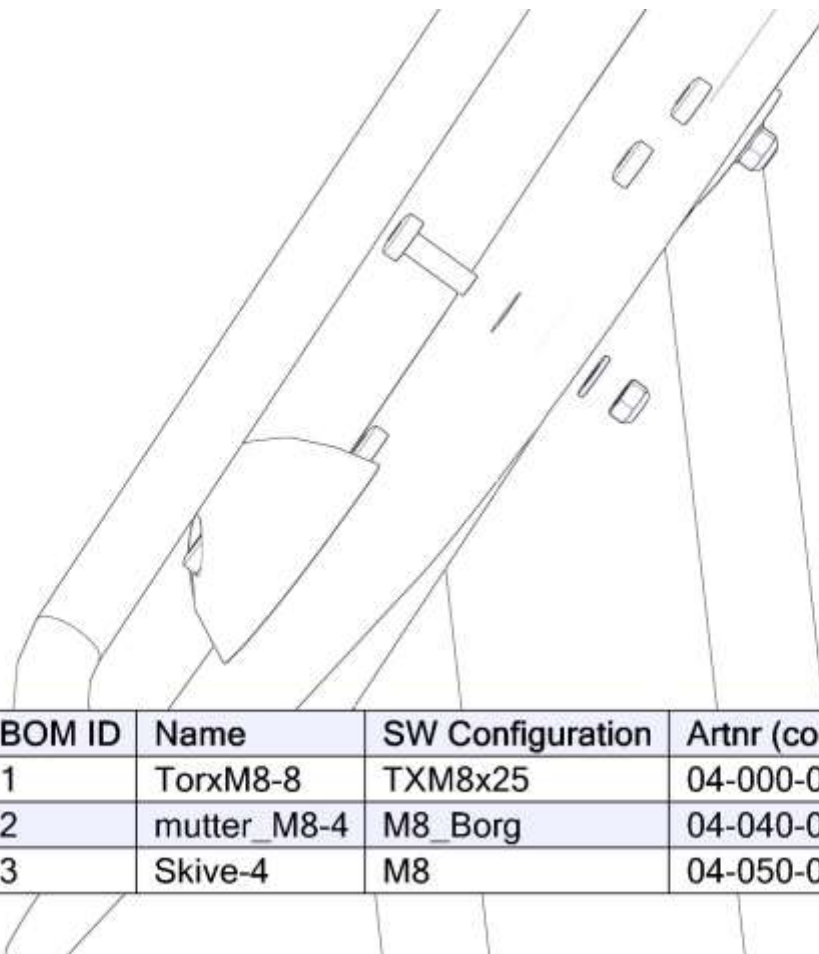

BOM ID	Name	SW Configuration	Artnr (config)	Qty
1	Torxm8-8	TXM8x25	04-000-025	1
2	mutter_M8-4	M8_Borg	04-040-008	1
3	Skive-4	M8	04-050-008	1

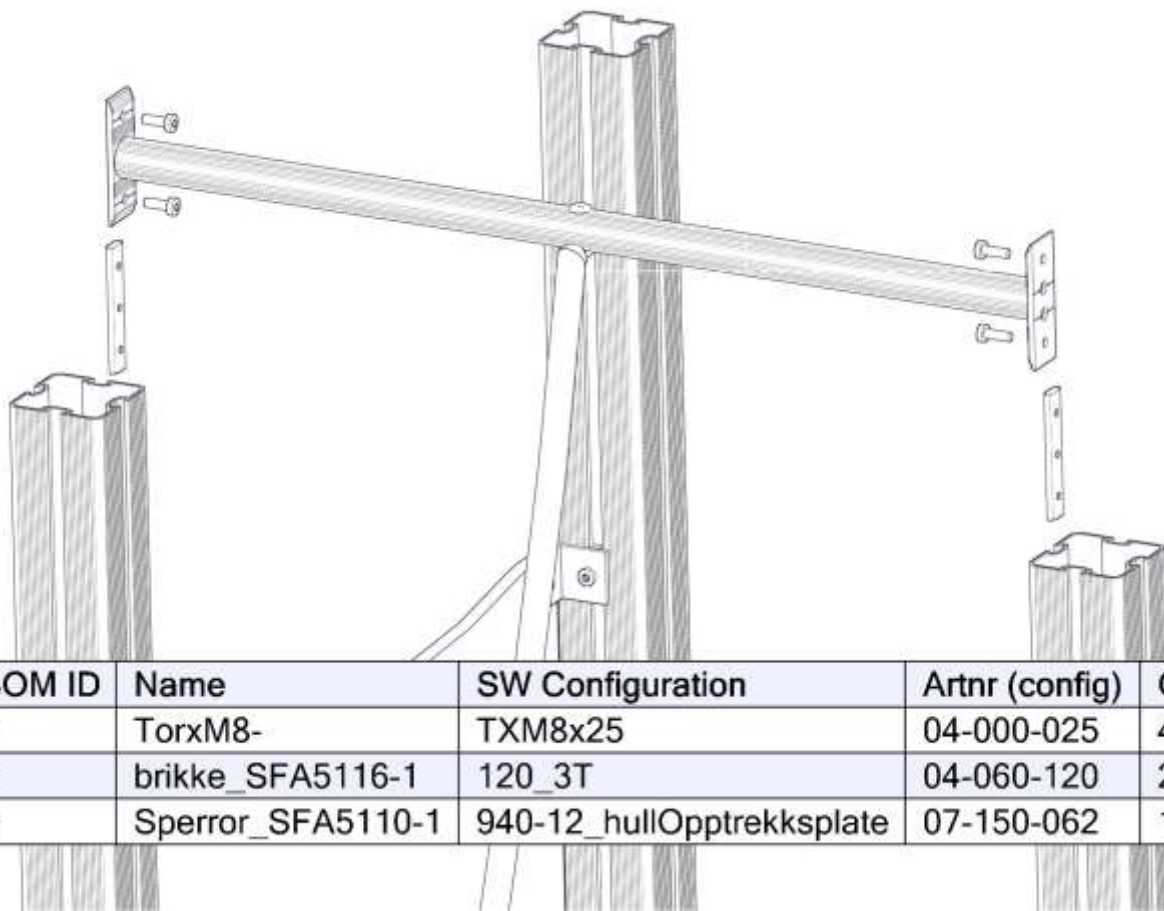

BOM ID	Name	SW Configuration	Artnr (config)	Qty
1	Torxm8-	TXM8x25	04-000-025	4
2	brikke_SFA5116-1	120_3T	04-060-120	2
3	Sperror_SFA5110-1	940-12_hullOpptreksplate	07-150-062	1

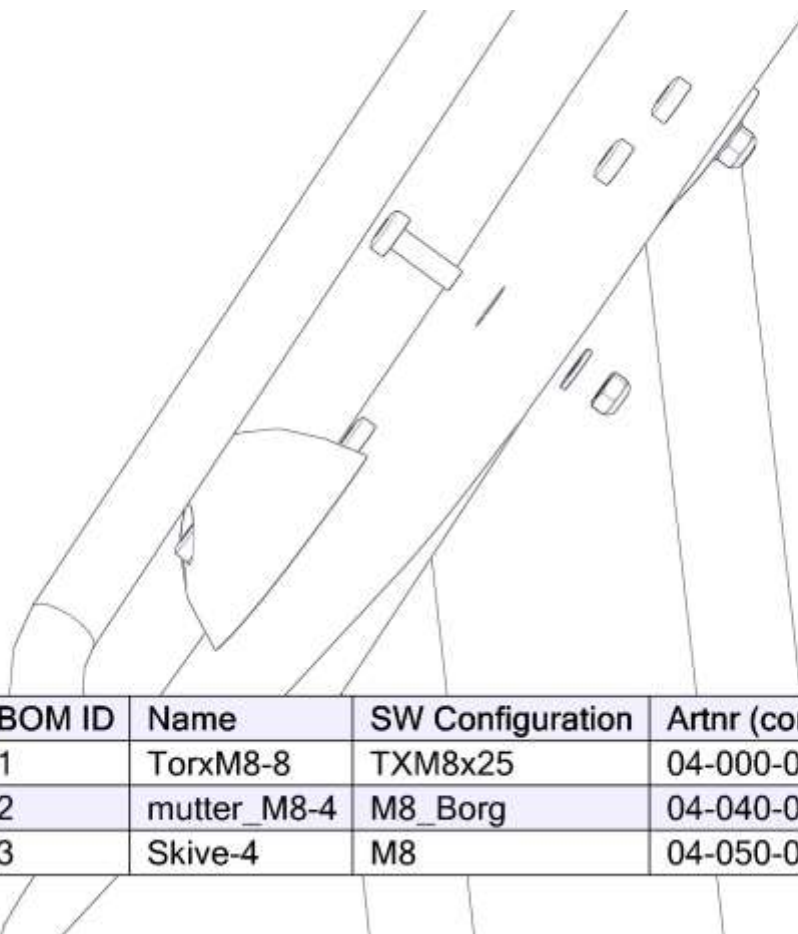

BOM ID	Name	SW Configuration	Artnr (config)	Qty
1	Torxm8-8	TXM8x25	04-000-025	1
2	mutter_M8-4	M8_Borg	04-040-008	1
3	Skive-4	M8	04-050-008	1

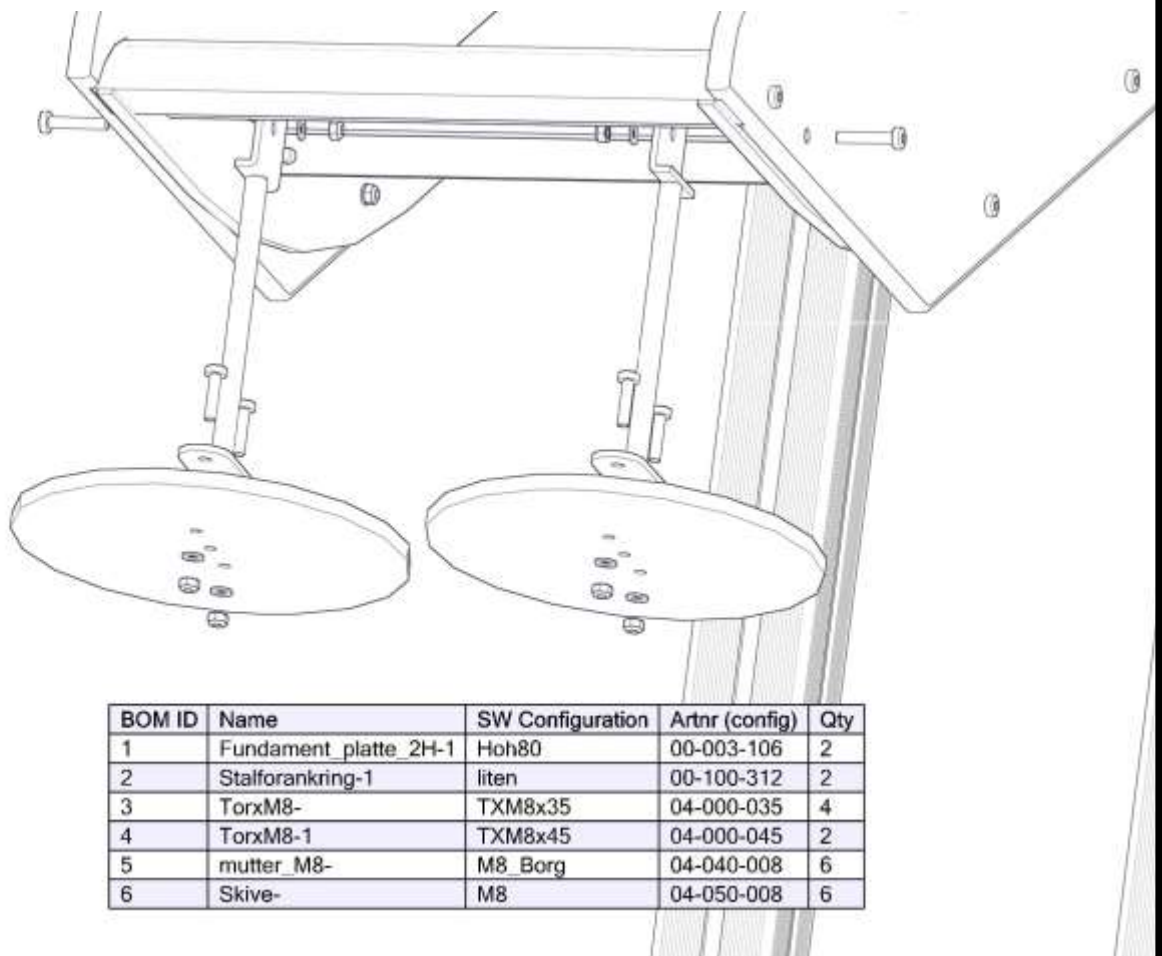
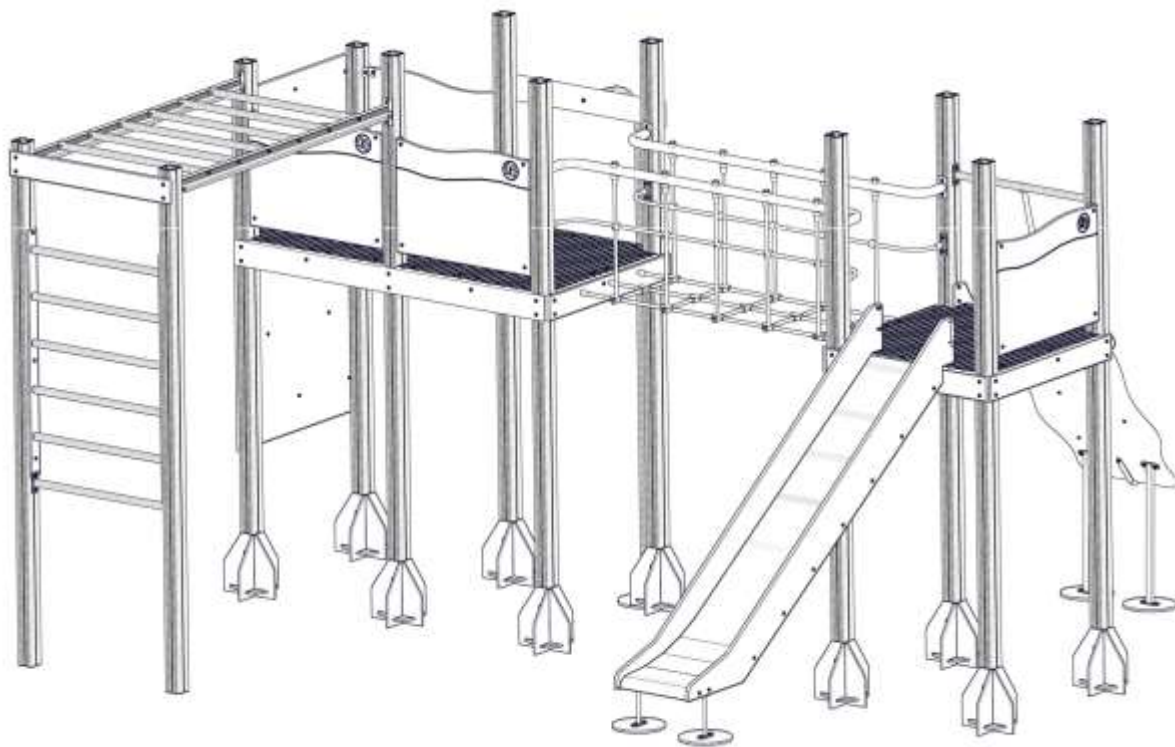

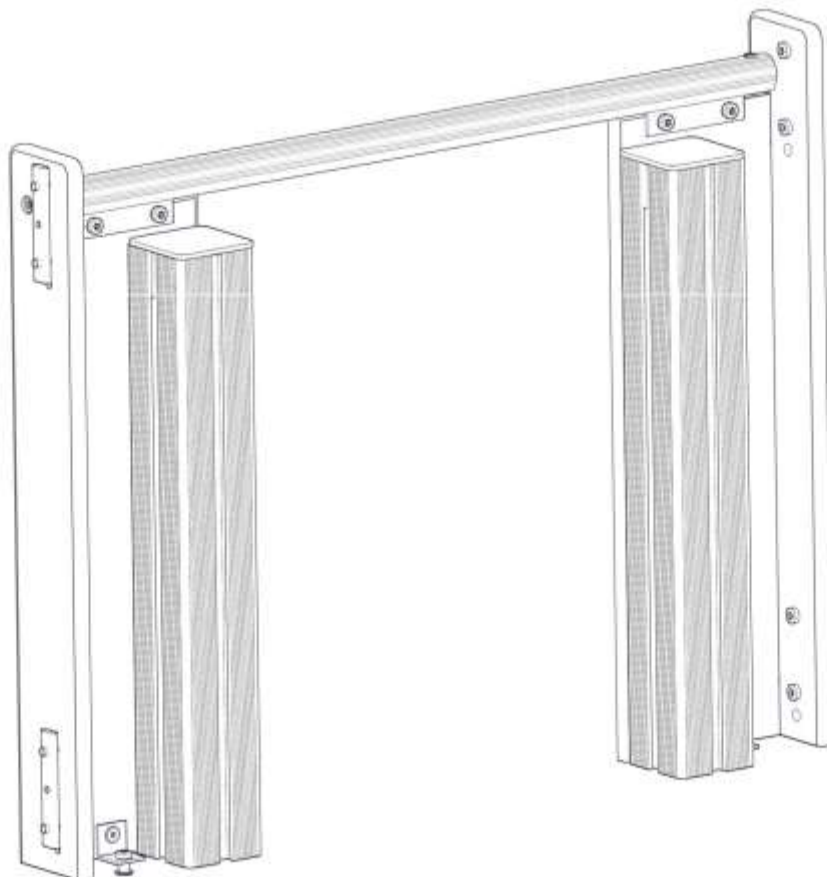
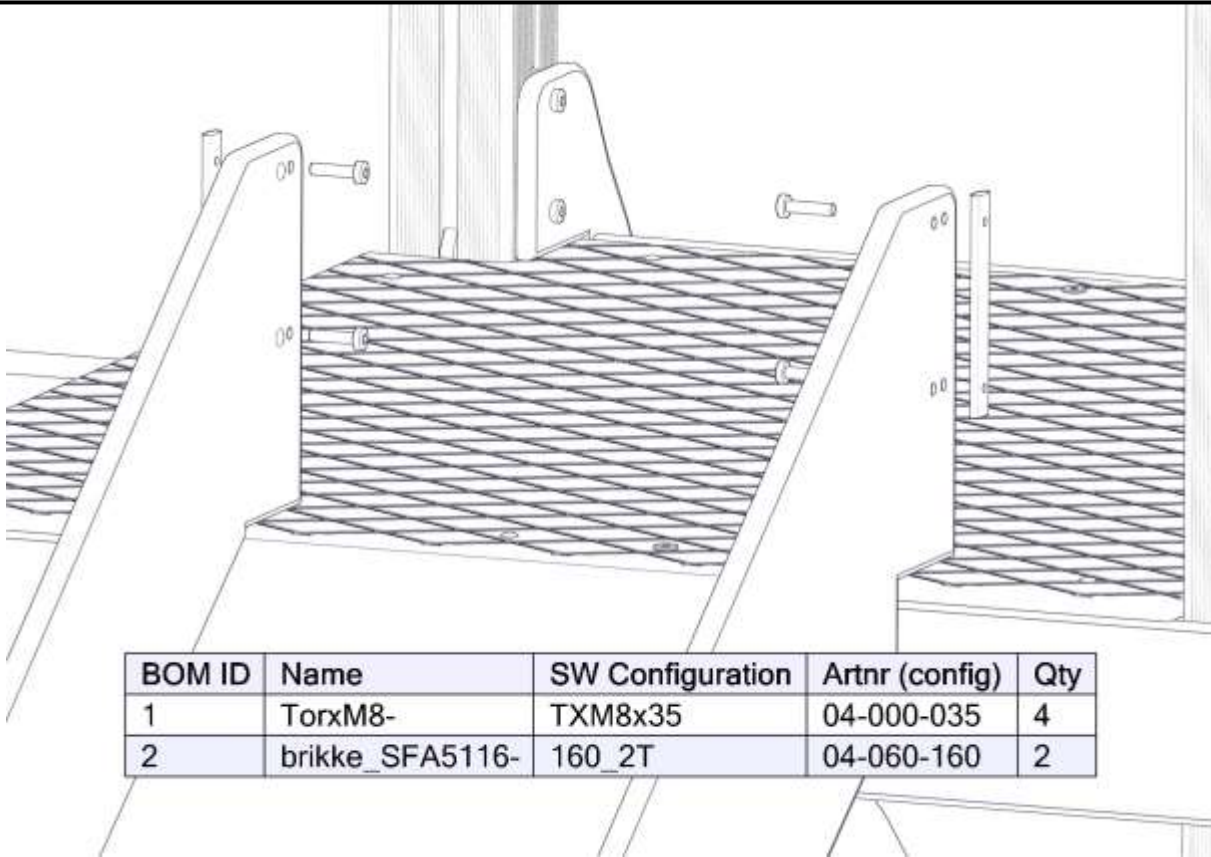

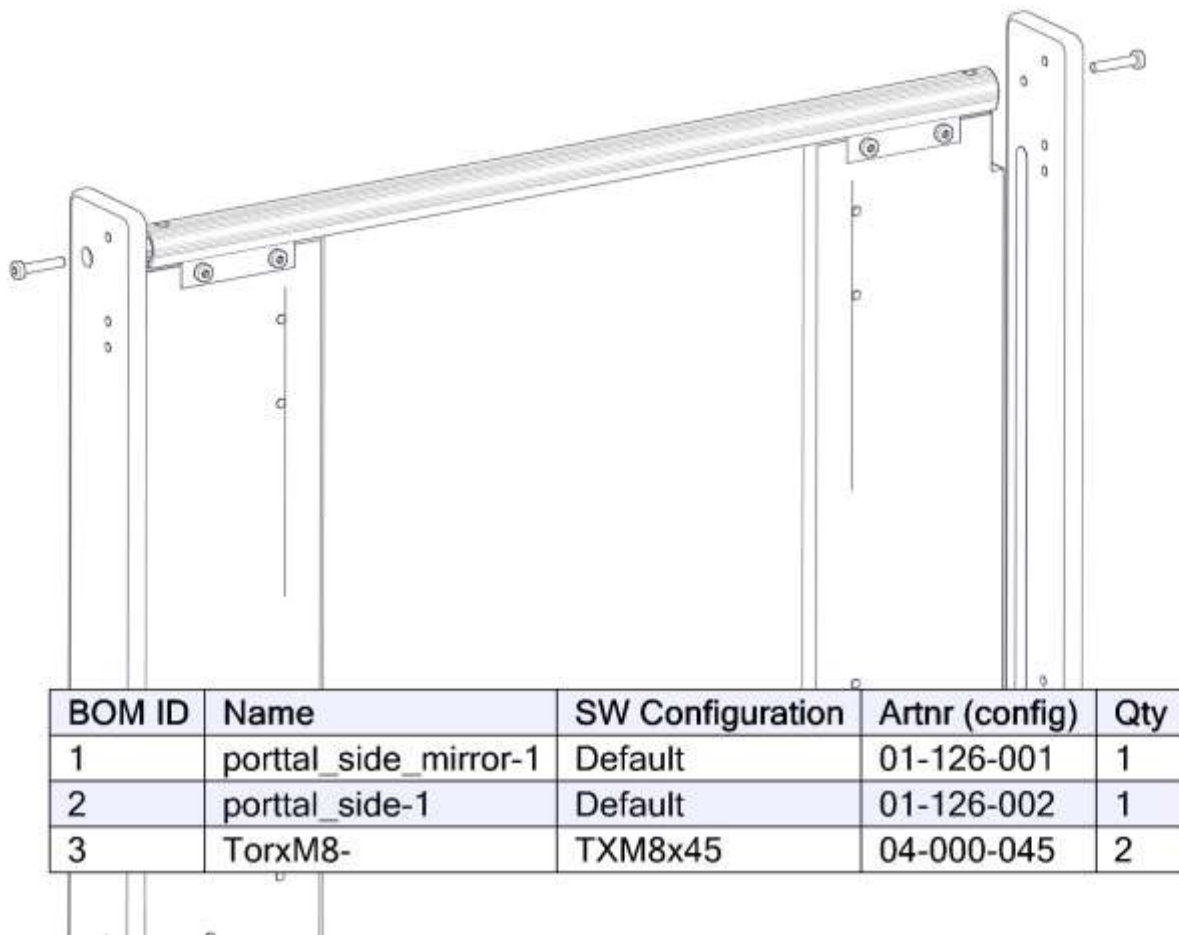
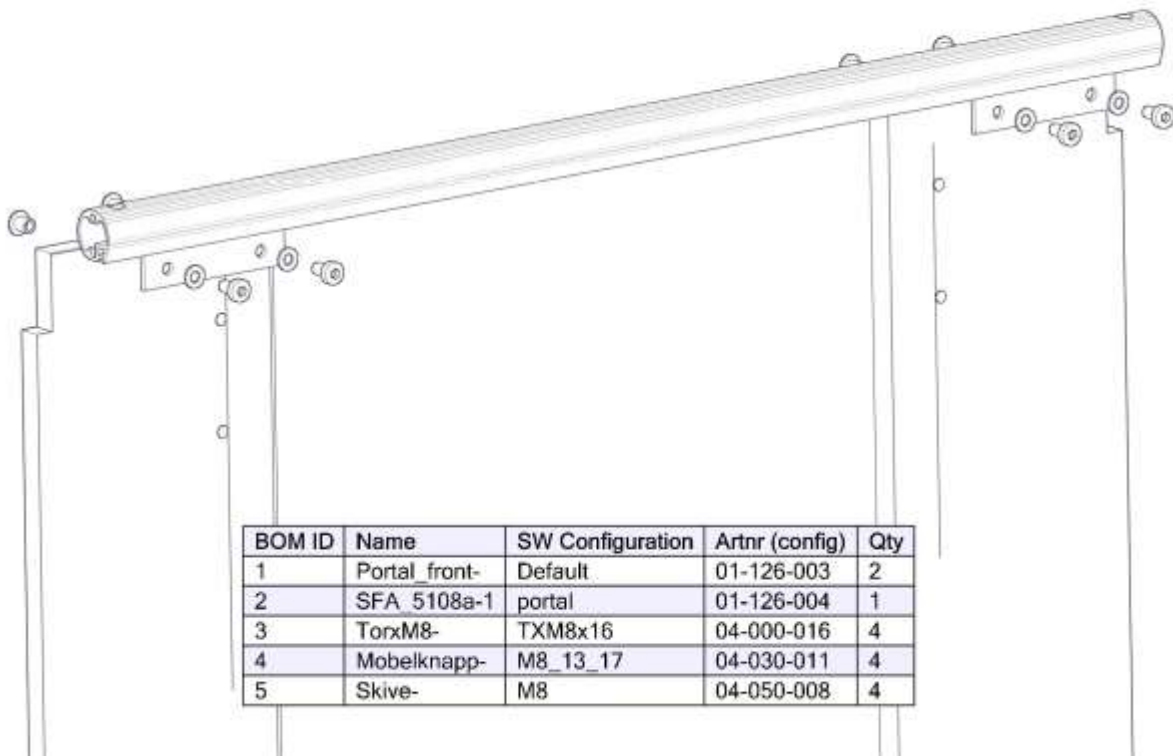

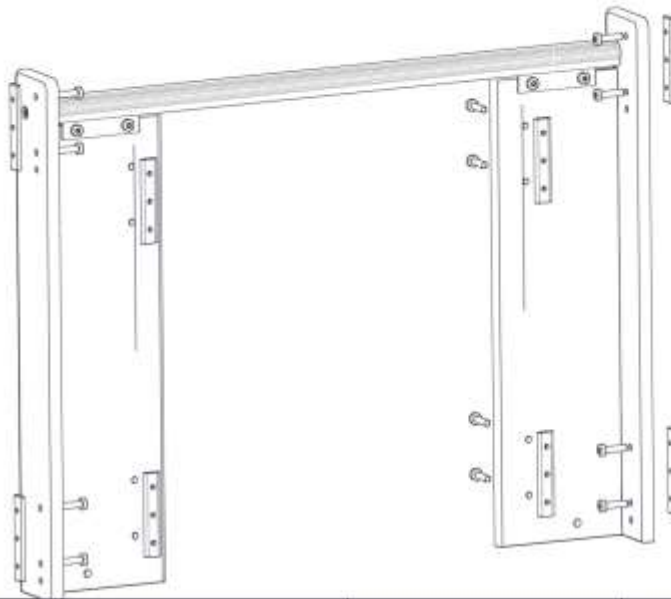

BOM ID	Name	SW Configuration	Artnr (config)	Qty
1	Torxm8-	TXM8x35	04-000-035	16
2	brikke_SFA5116-1	120_3T	04-060-120	8

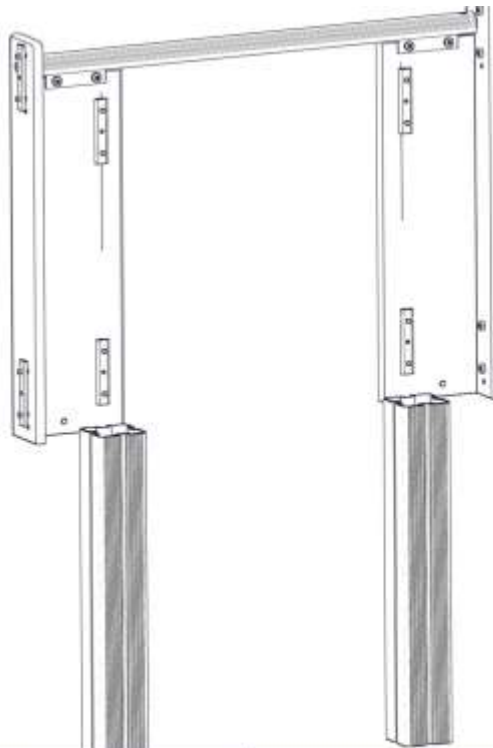

BOM ID	Name	SW Configuration	Artnr (config)	Qty
1	VK95_SFA5117_A-	Portal	00-400-009	2

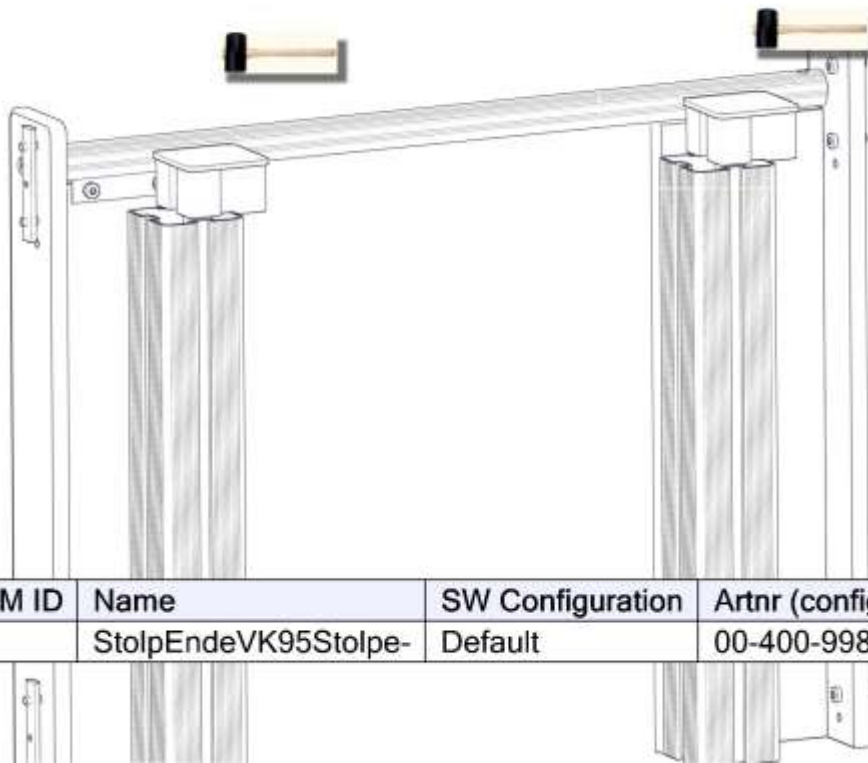

BOM ID	Name	SW Configuration	Artnr (config)	Qty
1	StolpEndeVK95Stolpe-	Default	00-400-998	2

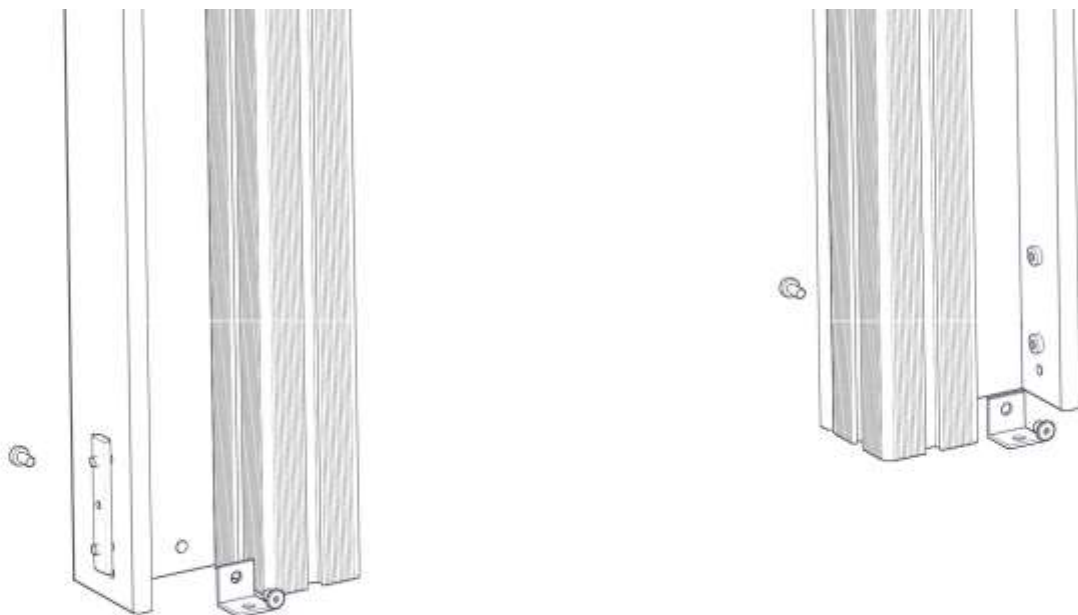

BOM ID	Name	SW Configuration	Artnr (config)	Qty
1	TorxM8-	TXM8x16	04-000-016	2
2	Mobelknapp-	M8_13_17	04-030-011	2
3	35x35x3-	11mm	04-070-036	2

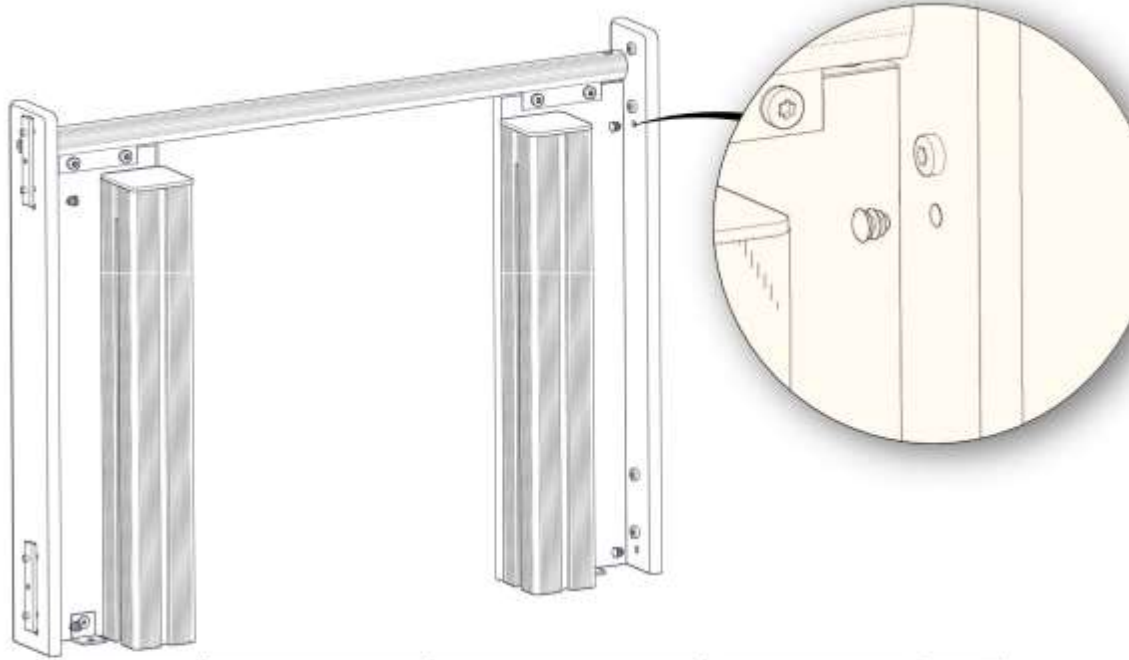

BOM ID	Name	SW Configuration	Artnr (config)	Qty
1	Prop_9-11mm-	Default	04-090-002	4

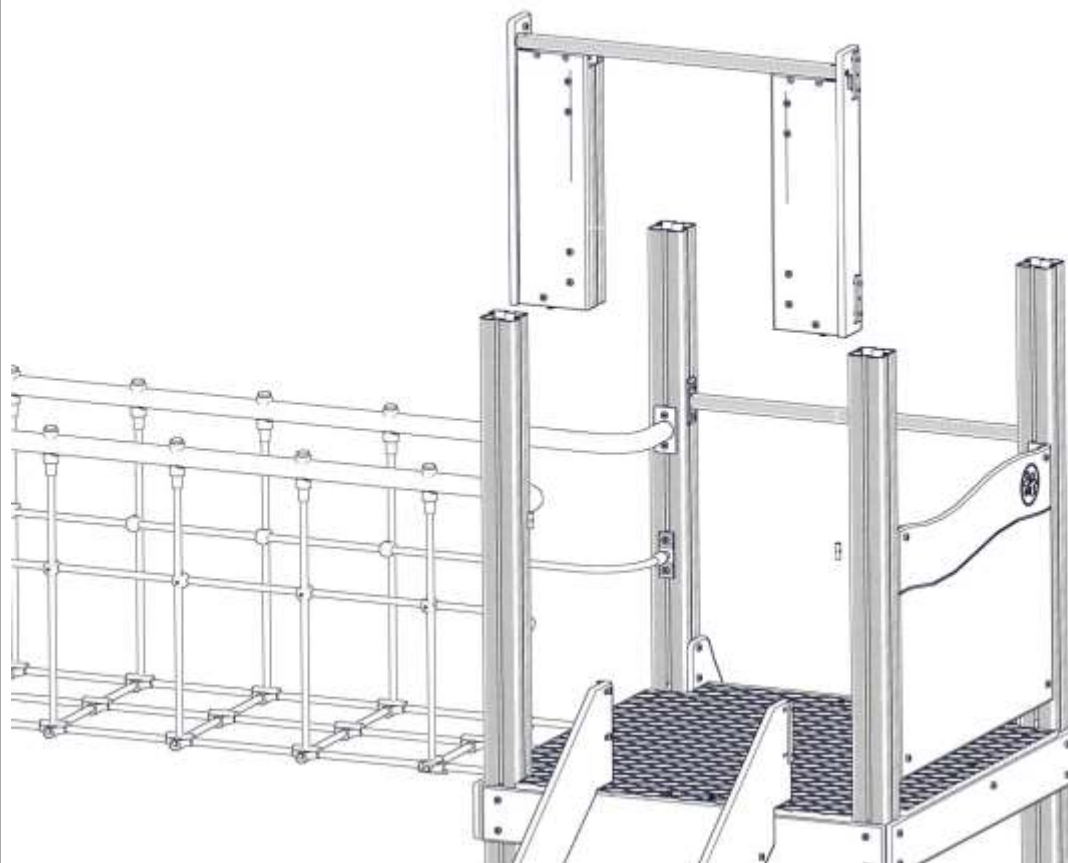

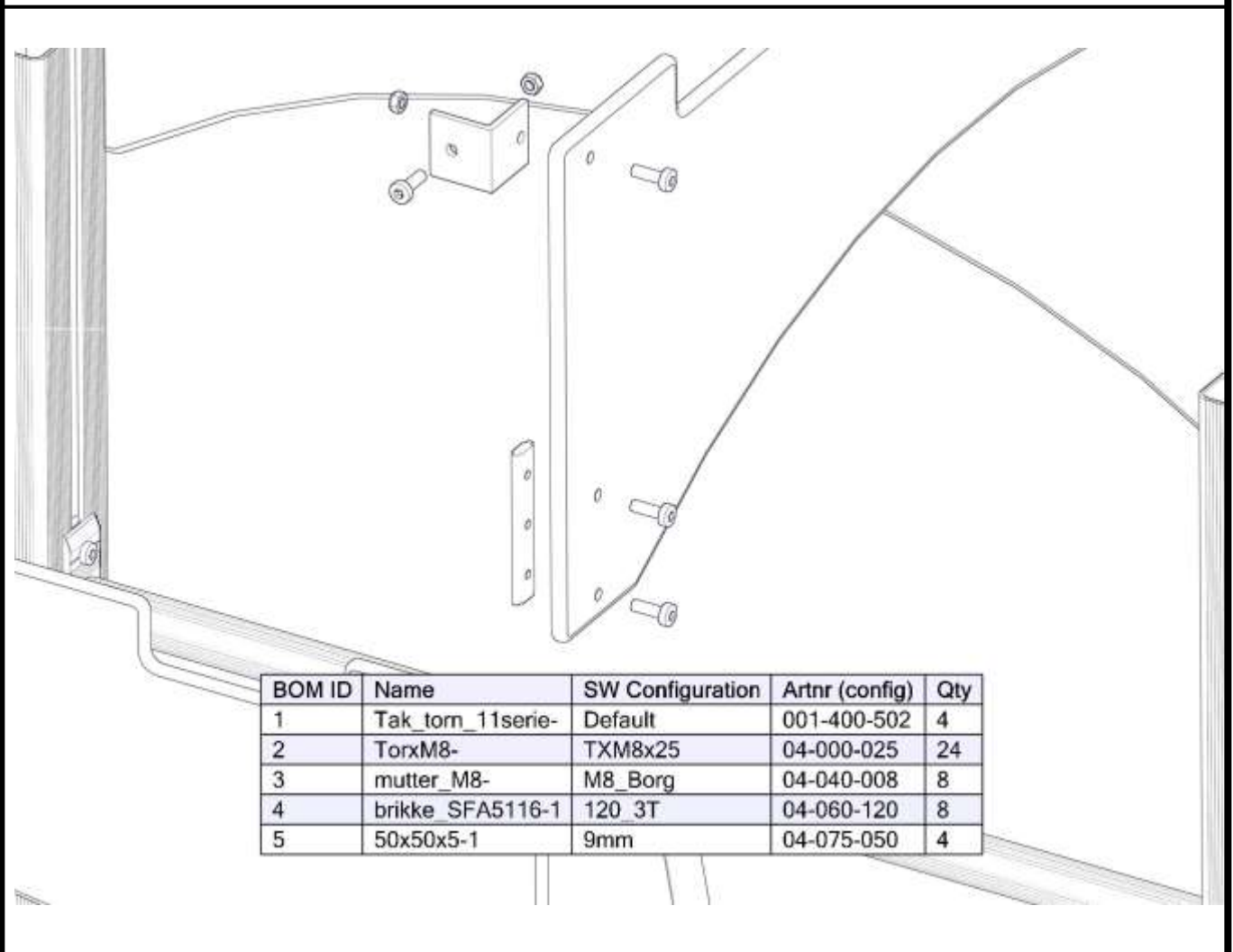
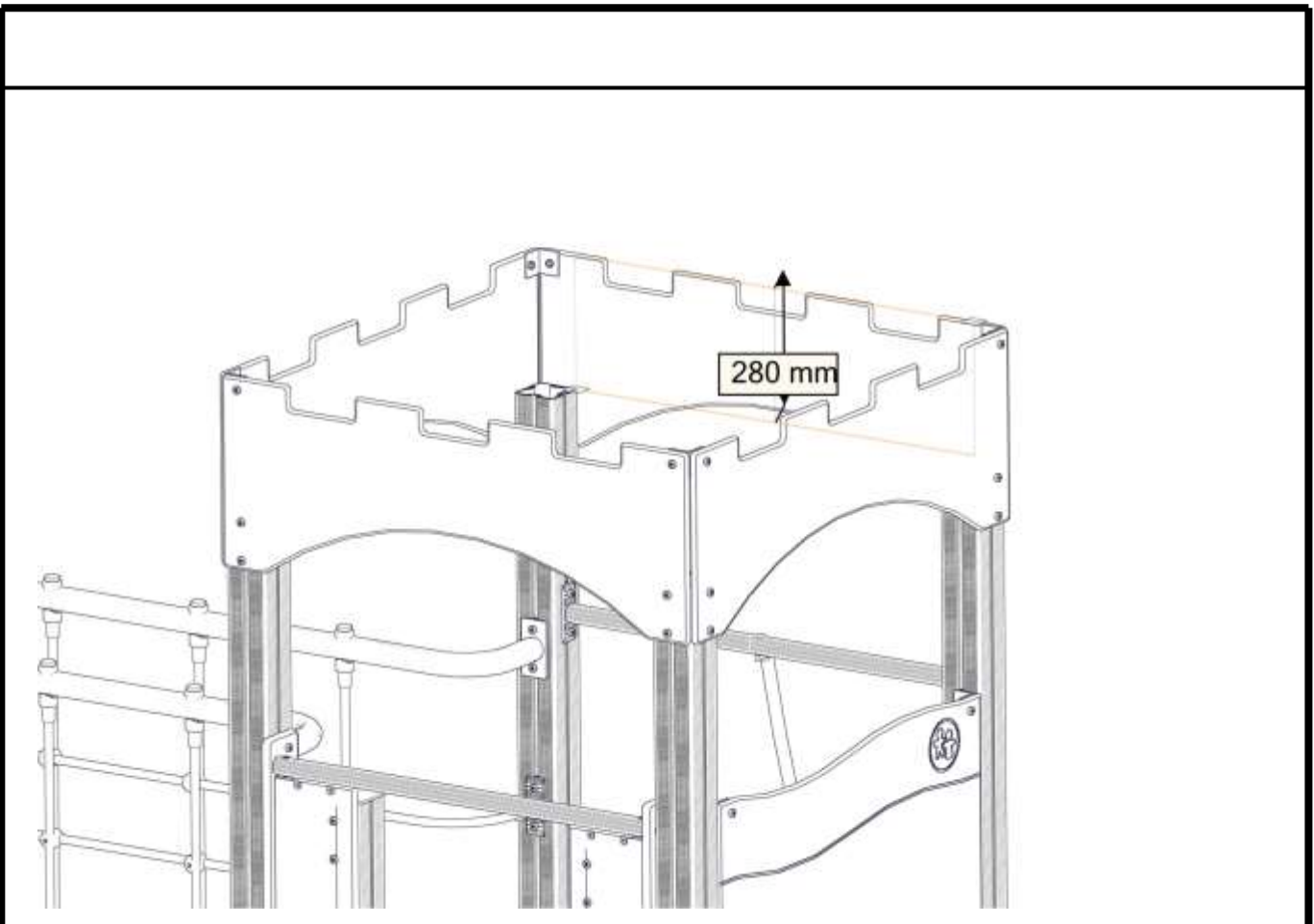

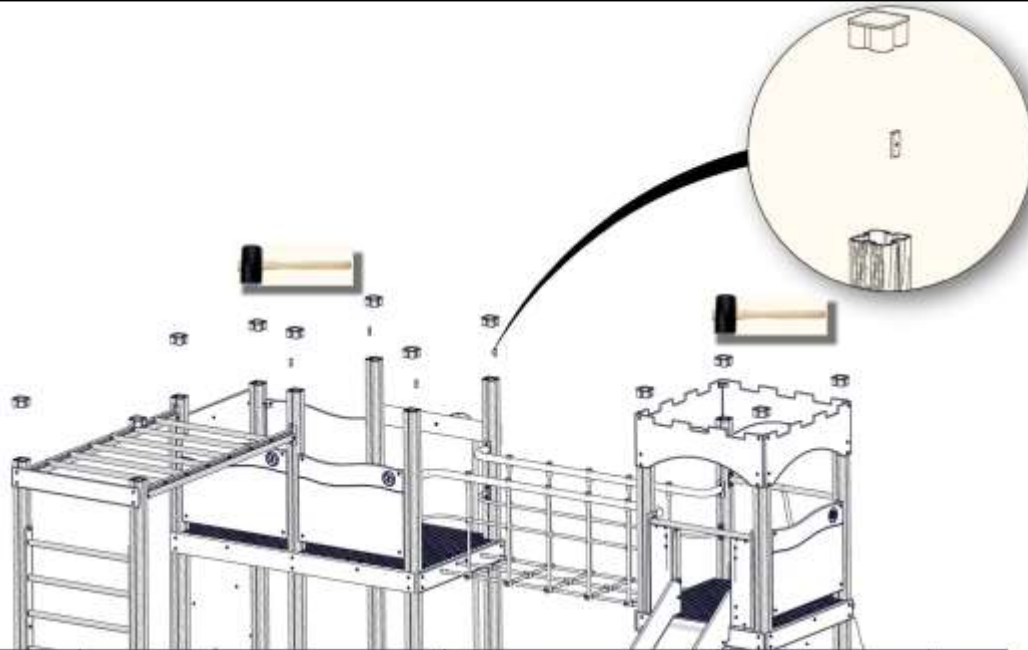

BOM ID	Name	SW Configuration	Artnr (config)	Qty
1	StolpEndeVK95Stolpe-1	Default	00-400-998	12
2	brikke_SFA5116-	50_1T	04-060-050	4

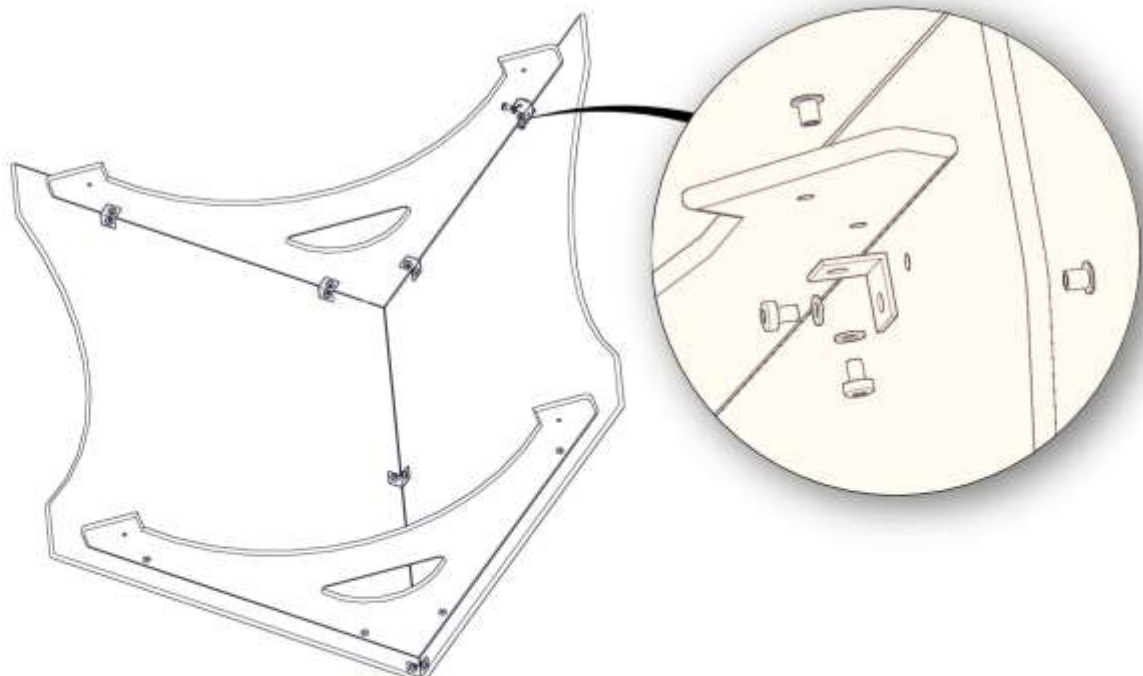

BOM ID	Name	SW Configuration	Artnr (config)	Qty
1	TakPlate-	Default	01-128-001	2
2	takGavelplate-	Default	01-128-002	2
3	TorxM8-	TXM8x12	04-000-012	22
4	Mobelknapp-	M8_13_17	04-030-011	22
5	Skive-	M8	04-050-008	22
6	35x35x3-1	11mm	04-070-036	11

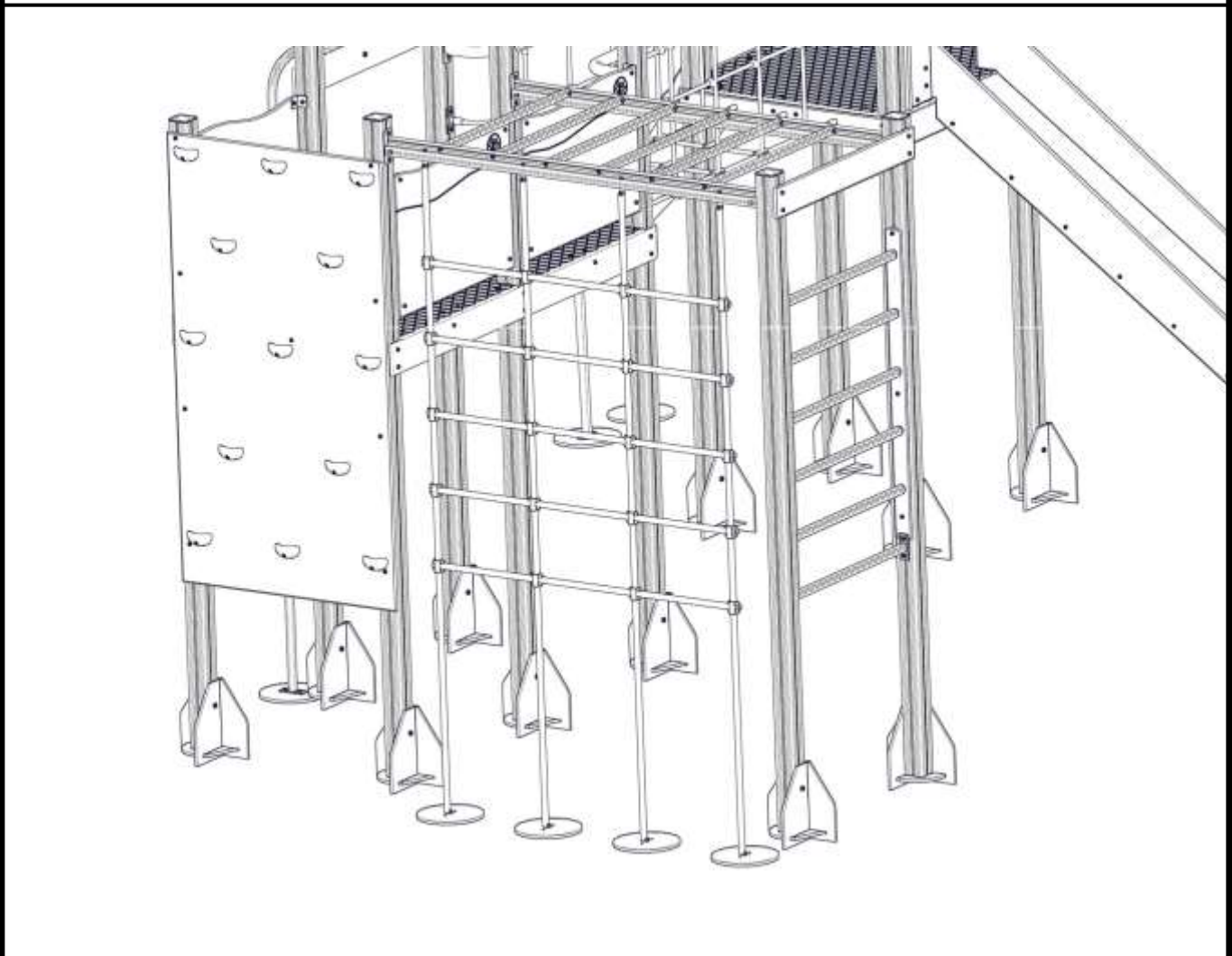
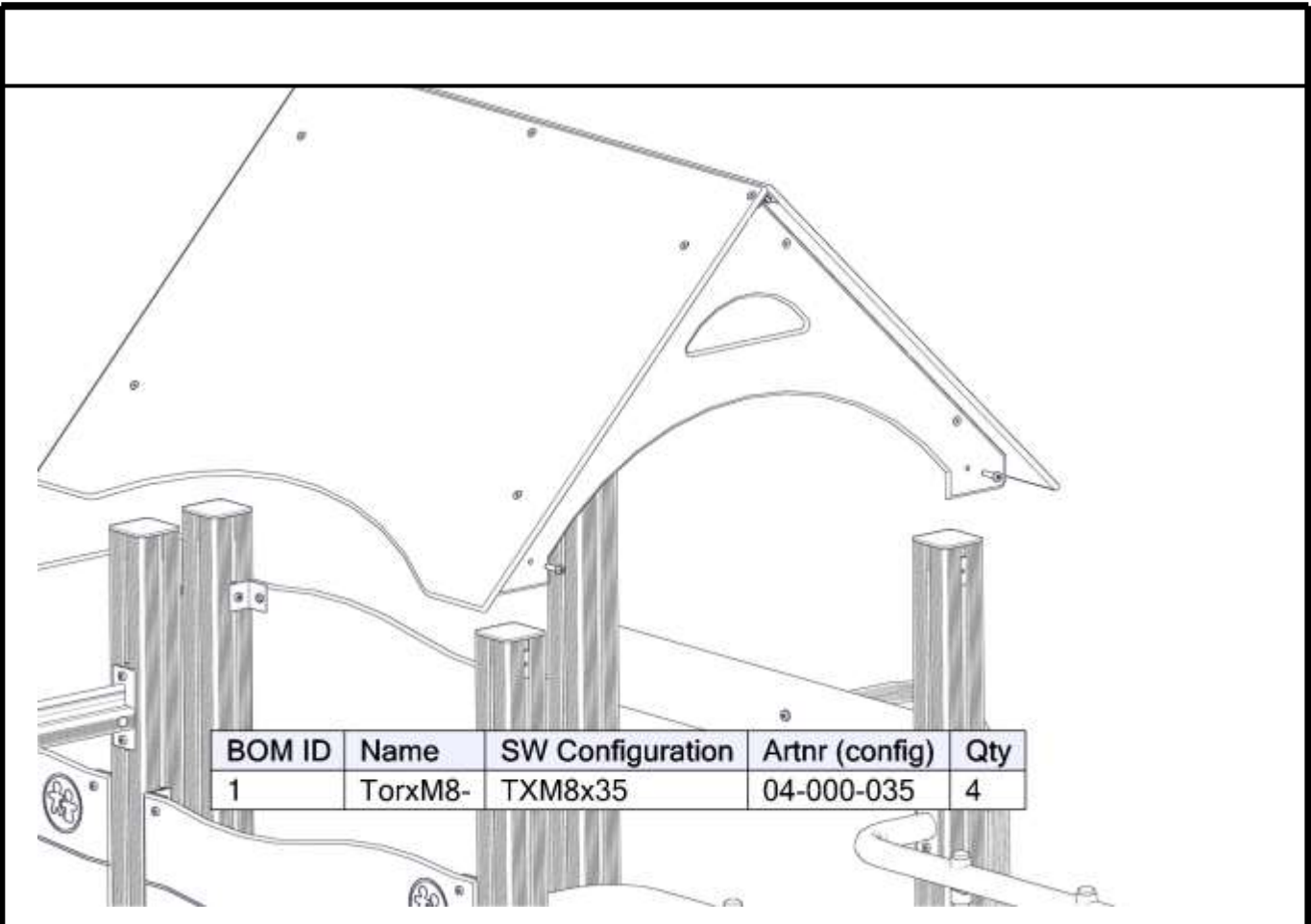

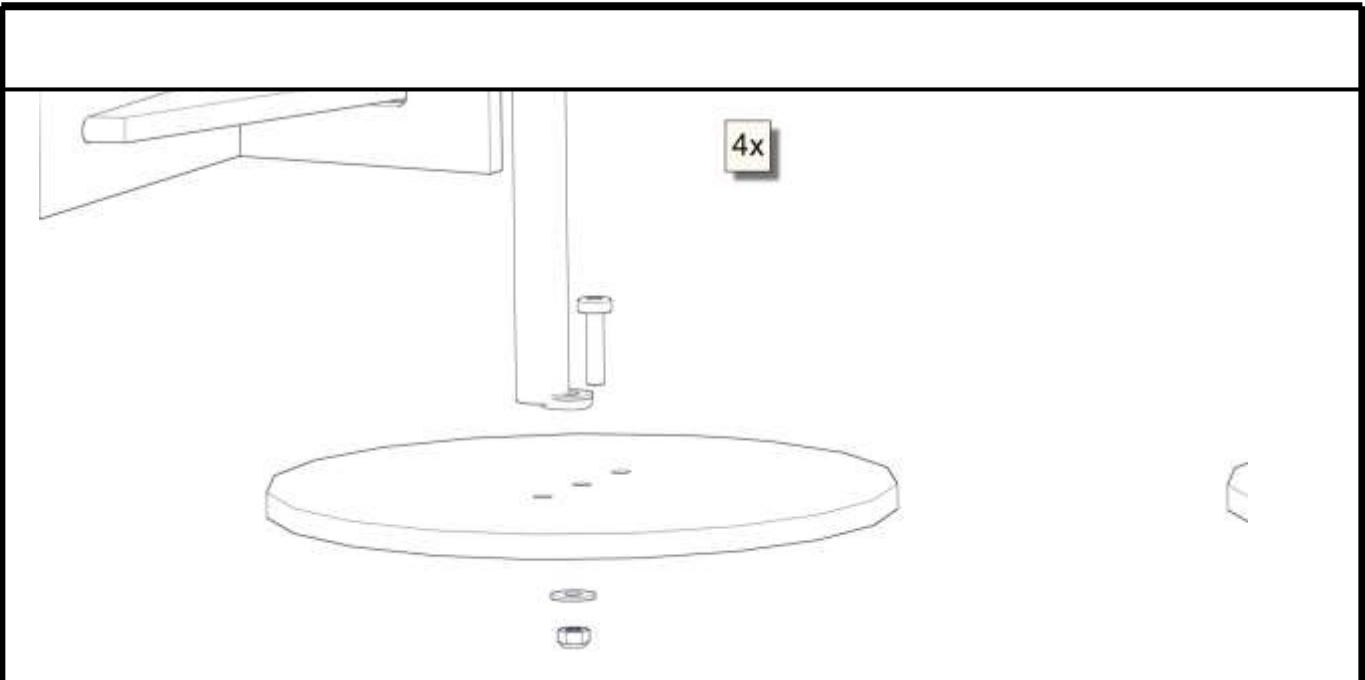



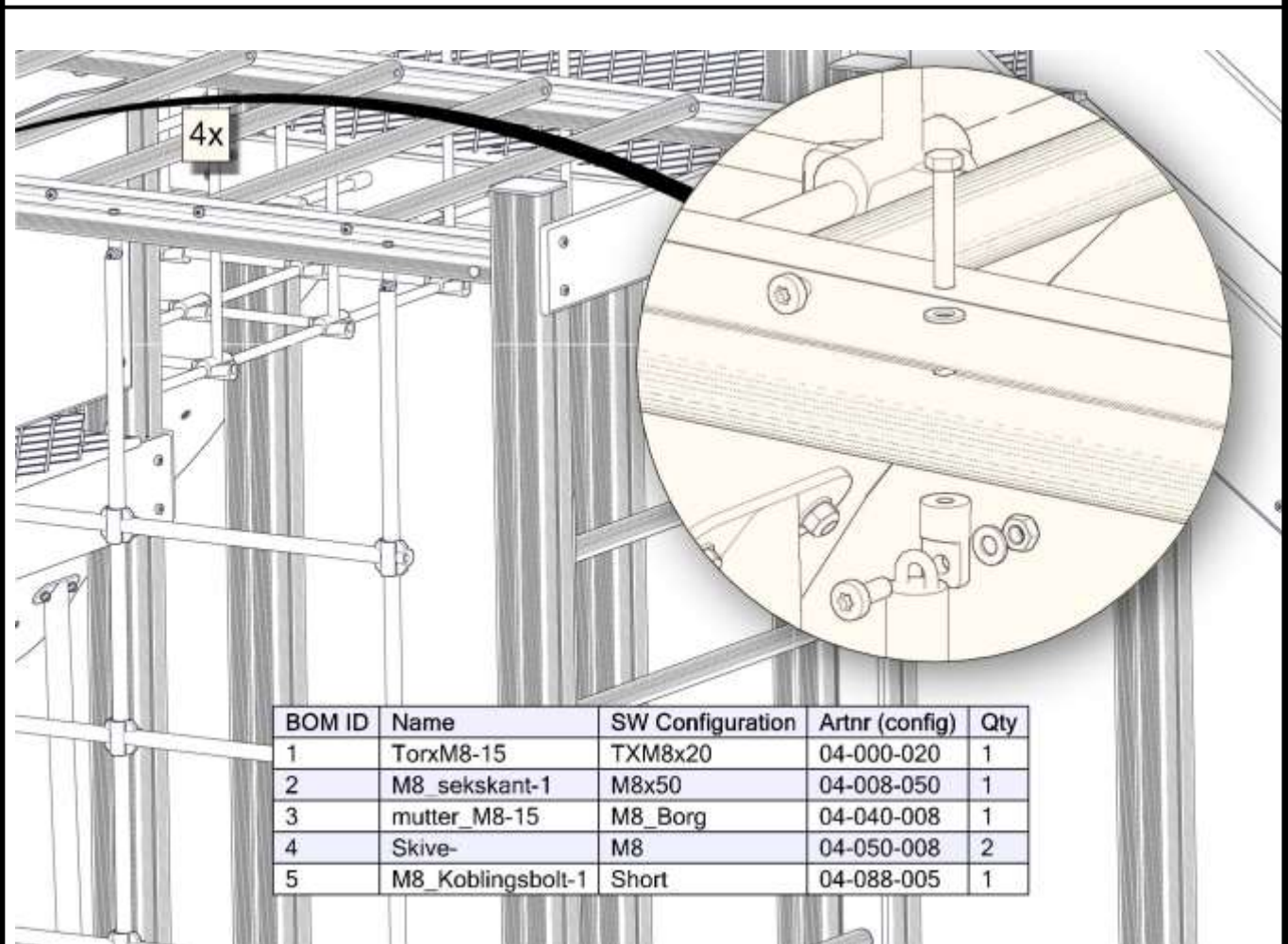







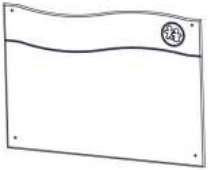





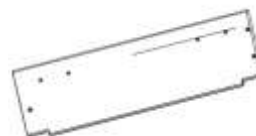





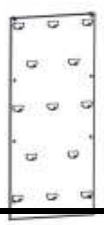

BOM ID	Name	SW Configuration	Artnr (config)	Qty
1	Fundament_platte_2H-4	Hoh80	00-003-106	1
2	TorxM8-8	TXM8x35	04-000-035	1
3	mutter M8-8	M8_Borg	04-040-008	1
4	Skive-9	M8_stor	04-055-008	1



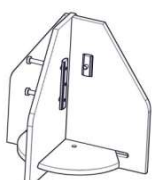



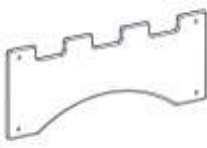













BOM ID	Name	SW Configuration	Artnr (config)	Qty
1	TorxM8-15	TXM8x20	04-000-020	1
2	M8_sekskant-1	M8x50	04-008-050	1
3	mutter M8-15	M8_Borg	04-040-008	1
4	Skive-	M8	04-050-008	2
5	M8_Koblingsbolt-1	Short	04-088-005	1

Før utstyret tas i bruk / Before play begins / Innan lekredskapet tas i bruk	
N	<ul style="list-style-type: none"> ● Påse at fallunderlag er utlagt i henhold til gjeldende regler eller vår anbefaling ● Fjern alle monteringshjelpemidler (rester av betong, planker, paller, plast, og lignende) ● Før utstyret tas i bruk, burde man sjekke at det ikke er fare for at anorakksnorer og lignende som kan hekte seg fast noen steder på lekeapparatet. (Vedlagte snor med dobbe (kneledd) kan brukes til å sjekke at dette er i orden. Se vedlagte veiledning for bruk av denne. Dette gjøres for å oppdage eventuelle feilmonteringer.?) ● NB! Bør stå i 2-3 dager før bruk
EN	<ul style="list-style-type: none"> ● Make sure the area and depth of safer surfacing are according to the current standard, or to the manufacturer's recommendation ● Make sure all tools and surplus materials are removed before play begins ● PS! When complete, allow 2-3 days for the concrete to set before use
S	<ul style="list-style-type: none"> ● Kontrollera att fallunderlag är utlagt enligt gällande regler eller vårt rekommendation ● Ta bort alla monteringshjälpmedel (rester av betong, plankor, pallar, plast och liknande) ● Innan lekredskapet används, kontrollera att anoracksnoddar eller kläder/delar av kläder eller liknande inte kan fastna i några delar på redskapet. (Den bipackade "knävringen" kan man med fördel användas för denna kontroll. ● Detta görs för att upptäcka eventuella felmonteringar.)

Boltepakker for / Boltpackage for / Bultpaket för		Sign. _____
	VK95 L=2900 1 600-2300 00-400-010	 Gulv 1 1160x1160x15 00-400-300
	VK95 L=3035 1 600-2435 00-400-053	
	VK95 L=3235 8 600-2635 00-400-009	 Ende lokk 14 00-400-998
	VK95 L=640 2 01-126-005	
	Vegg 4 940x686x12 01-125-002	 Gulv dobbel 1 Klatrevegg 2180x1160x15 00-400-351_CUT
	Sprosse 4 1130x145x15 Med hull poly- fix nett 01-400-112	
	Sprosse 5 1130x145x15 01-400-108	 Sprosse 2 2165x145x15 01-400-203
	Sprosse 1 1130x145x15 01-400-108 Hull brannstang	 Frontplate portal 2 01-126-003
	Sideplate portal 1 Høyre 01-126-001	 Side plate portal 1 Venstre 01-126-002
	Sperrerør portal 1 01-126-004	 Brannstang 1 01-400-108

Boltepakker for / Boltpackage for / Bultpaket för			Sign. _____
	Tak 1280x960x12 01-128-001	2	Gavelplate 01-128-002
			
			
	Rør rett 07-500-027	2	
			Nett rett brua 07-500-043
	Sprosse ribbe- vegg 01-400- 108	1	
			Eventuelt funda- menter
	Stolpe med HPL 600- 2435=3035 00-400-016	1	
			Stolpe med HPL 600-2435=3035 00-400-017
	Sperrerør med beslag L=940 00-400-150	1	
			Ribbevegg rør 00-400-149 L=940
	Tak borg 01-400-502	4	
			Systembane 1400 40-142-101

Boltepakker for / Boltpackage for / Bultpaket för		Sign. _____
	Opptreksplate 1 01-129-112	Feste HPL 2 01-129-113
	Sperrerør med kjetting 1 00-261-500 L=2440	U-profil 1 02-500-086 L=910
	Stålforankring 2 01-129-114	Fundametplate 9 00-003-106
	SFA 5104 1 L=1980 00-400-810	SFA 5104 1 L=1980 med hull N-nett 00-400-809
	Ribbe takk 6 07-150-062 L=1026	N-nett 1 05-156-003
	Sekskant 4 M8x50 04-008-050	Koblingbolt 4 04-088-005
		Produktmerke Montert hos Søve
		

Boltepakker for / Boltpackage for / Bultpaket för			Sign. _____		
	Torx M8x12 04-000-012	30		Brikke 50-1T 04-060-050	28
	Torx M8x16 04-000-016	6		Brikke 120-3T 04-060-120	32
	Torx M8x20 04-000-020	4		Brikke 150-3T 04-060-150	4
	Torx M8x25 04-000-025	81		Brikke 160-3T 04-060-160	4
	Torx M8x30 04-000-030	28		Låsemutter M8 04-040-008	72
	Torx M8x35 04-000-035	86		Låsemutter M10 04-040-010	10
	Torx M8x40 04-000-040	3			
	Torx M8x45 04-000-045	23		Stålforankring 00-100-310	2
Torx M8x50 04-000-050	8				
	Møbelknapp M8x13x17 04-030-011	36		Hylsemutter M8 12-38 04-018-060	17
	04-030-016	3			
	Plast rondell 05-300-036	10		Plast rondell 05-300-036	20
	Plast plug 9-11mm 04-090-002	44		Plug spor 00-400-980	22
	Skive M8 04-050-008	80		Vinkel 35x35x35 04-070-036	15
	Skive M8 04-055-008	1		Vinkel 50x50x50 04-075-050 9mm	20
	Skive M10 Poly 04-055-036	20		Vinkel 50x50x50 04-070-050 11mm	8